



Iris um Oifig Maoine Intleachtúla na hÉireann
Journal of the Intellectual Property Office of Ireland

Iml. 95

Cill Chainnigh 04 March 2020

Uimh. 2406

CLÁR INNSTE

Cuid I		Cuid II	
Paitinní	Leath	Trádmharcanna	Leath
Official Notice	671	Official Notice	416
Applications for Patents	672	Applications for Trade Marks	417
Applications Published	673	Oppositions under Section 43	500
Patents Granted	674	Application(s) Amended	500
European Patents Granted	675	Application(s) Withdrawn	501
Applications Withdrawn, Deemed Withdrawn or Refused	829	Trade Marks Registered	501
Applications Lapsed	829	Trade Marks Renewed	502
Patents Lapsed	829	Application(s) for Leave to Alter Registered	
Patents Expired	830	Trade Mark(s)	505
Request for Grant of Supplementary Protection Certificate	839	Trade Mark(s) Restored	505
Supplementary Protection Certificate Granted	839	International Registrations under the Madrid Protocol	506
Supplementary Protection Certificate Rejected	840	International Trade Marks Protected	556
Application for Extension of the Duration of a Supplementary Protection Certificate	840	Cancellations effected under the Madrid Protocol	558
Grant of Extension of Duration of a Supplementary Protection Certificate	841	Errata	558
Dearachtaí			
Designs Information under the 2001 Act			
Designs Registered	842		
Designs Renewed	846		
Design Rights Expired	846		

The Journal of the Intellectual Property Office of Ireland is published fortnightly.

Each issue is freely available to view or download from our website at
www.ipoi.gov.ie

© *Rialtas na hÉireann, 2020*

© *Government of Ireland, 2020*

Iris um Oifig Maoine Intleachtúla na hÉireann
Journal of the Intellectual Property Office of Ireland

Cuid I

Paitinní agus Dearachtaí

No. 2406

Wednesday, 4 March, 2020

NOTE: *The office does not guarantee the accuracy of its publications nor undertake any responsibility for errors or omissions or their consequences.*

<p>In this Part of the Journal, a reference to a section is to a section of the Patents Act, 1992 unless otherwise stated.</p>
--

Official Notice

Patent Rules 1992 – Rule 77 – Office Closure

This Office will be closed to the public on the Tuesday 17th March 2020.

Register of Patent Agents

Examination in Law & Practice of Patents

Subject to there being a sufficient number of candidates, it is proposed to hold a written examination in the law and practice of Patents on **22 April 2020**. The latest date for receipt of applications from persons who wish to sit this written examination is **1 April 2020**.

Candidates wishing to be examined must have submitted in advance to the Controller an application form and fee of €200 not later than **1 April 2020**.

Applicants who wish to sit the examination will be notified of the venue and furnished with other relevant information in due course.

Applications for Patents From 05/01/2020 to 13/02/2020

The names of applicants are in alphabetical order. In the case of joint applicants, each name is given independently. The title of the invention should not be regarded as an exhaustive indication of the subject-matter. The date immediately following the title is that on which the application was filed; in the case of a divisional application, the filing date of the earlier application is added within parentheses. In the case of a Convention application the Convention country and priority date(s) claimed are given in square brackets and where an application claimed the priority of an earlier application filed at the office, this information is given within the square brackets. The number is that of the application and should be used for correspondence purposes up to the date of grant of a patent. The letter S preceding the number indicates that the application is for a short-term patent. A new number will be given when a patent is granted and this new number should be quoted in all correspondence subsequent to grant.

BERGIN CILLIAN; HAUGH MICHAEL Electricity generating chimney turbine 09 January 2020	S20200015
CORCORAN MICHAEL; KAMBOJ MAYA In-Line Water Monitor 05 January 2020	S20200016
FYNES DEBORAH A massage device 05 February 2020	S20200019
HAUGH MICHAEL; BERGIN CILLIAN Electricity generating chimney turbine 09 January 2020	S20200015
HENDERSON PATRICK High prebiotic fibre nutritious wet filling 13 February 2020	S20200028
KAMBOJ MAYA; CORCORAN MICHAEL In-Line Water Monitor 05 January 2020	S20200016
KEMPLE DERMOT Devise to help golfers train their shoulder in the back-swing in order to generate more power and consistency 08 February 2020	S20200025
MCAS DESIGN LIMITED A PERIPHERAL VENOUS ACCESS AID 10 February 2020	20200027
PSE COMPOSITES LIMITED A BALANCE GUIDE FOR A TUBULAR ELEMENT 10 February 2020	20200026
RICE RESEARCH INSTITUTE OF FUJIAN ACADEMY OF AGRICULTURAL SCIENCES; SHENGPING LI; JIANBO FANG; CHAOPING CHENG; XIANGHUA ZHENG; NING YE Method for improving pollination efficiency of conventional rice hybridization 06 February 2020 [China-30 April 2019]	S20200017
SHERIDAN DESMOND Improvement relating to golf cart 05 February 2020	S20200020
TIMONEY DYNAMIC SOLUTIONS LIMITED Gas Spring 07 February 2020	20200021

TIMONEY DYNAMIC SOLUTIONS LIMITED A Vehicle Spring 07 February 2020	20200022
TIMONEY DYNAMIC SOLUTIONS LIMITED Vehicle Suspension Gas Spring 07 February 2020	20200023
TIMONEY DYNAMIC SOLUTIONS LIMITED Spring Damper Assembly 07 February 2020	20200024
ULTRA HIGH VACUUM SOLUTIONS LTD Silicon surface preparation for dry etching texturing process. 03 February 2020	20200018

Applications Published Under Section 28

The following applications become open to public inspection as from the date of this issue of the journal. The date given is the date of filing of the application or the earliest priority claimed.

2018	20180170	PATRICK NOEL DALY, An adjustable mattress. 21 June 2018. Int. Cl. (2020.01) A47C 27/00 .
	20180232	HARTECAST LIMITED, Retaining ground socket for removable bollard. 22 August 2018. Int. Cl. (2020.01) E01F 9/00; E04H 12/00 .
	S20180258	CHENGDU KA DI FU TECHNOLOGY CO., LTD., Drug intermediates 1, 4-pregnenetriene-9a-fluoro-11 β , 17a, 21-triol-3, 20-dione-17, 21-diacetate synthesis method. 23 August 2018. Int. Cl. (2020.01) C07J 5/00 .
	S20180260	CHENGDU KA DI FU TECHNOLOGY CO., LTD., Drug intermediates 1-methyl-2-quinolinone synthesis method. 23 August 2018. Int. Cl. (2020.01) C07D 215/00 .
	S20180267	CHENGDU KA DI FU TECHNOLOGY CO., LTD., Aminoquinone drug intermediates tetrachlorobenzoquinone synthesis method. 23 August 2018. Int. Cl. (2020.01) C07C 46/00 .
	S20180268	CHENGDU KA DI FU TECHNOLOGY CO., LTD., Organic synthesis intermediates anthraquinone synthesis method. 23 August 2018. Int. Cl. (2020.01) C07C 46/00 .
	S20180269	CHENGDU KA DI FU TECHNOLOGY CO., LTD., Stomach rehabilitation drug intermediates diphenylglycolic acid synthesis method. 23 August 2018. Int. Cl. (2020.01) C07C 51/00 .
	S20180270	CHENGDU KA DI FU TECHNOLOGY CO., LTD., Organic analytical reagent diphenylcarbazone synthesis method. 23 August 2018. Int. Cl. (2020.01) C07C 281/00 .

- S20180272** CHENGDU KA DI FU TECHNOLOGY CO., LTD., Post-efficiency promoter n-cyclohexyl-2-benzothiazole sulfenamide synthesis method. 23 August 2018. Int. Cl. (2020.01) **C07D 277/00**.
- S20180273** CHENGDU KA DI FU TECHNOLOGY CO., LTD., Vulcanization accelerator 2 benzothiazolyl-n-morpholino sulfide synthesis method. 23 August 2018. Int. Cl. (2020.01) **C07D 417/00**.
- S20180275** CHENGDU KA DI FU TECHNOLOGY CO., LTD., Drug intermediates 3-oxoheptanone ethylene glycol synthesis method. 23 August 2018. Int. Cl. (2020.01) **C07C 317/00**.
- S20180276** CHENGDU KA DI FU TECHNOLOGY CO., LTD., Organic synthesis intermediate 4-methylcyclohexanone synthesis method. 23 August 2018. Int. Cl. (2020.01) **C07C 45/00**.
- S20180277** CHENGDU KA DI FU TECHNOLOGY CO., LTD., Organic intermediate 1,6-cyclohexanedione synthesis method. 23 August 2018. Int. Cl. (2020.01) **C07C 45/00**.
- S20180278** CHENGDU KA DI FU TECHNOLOGY.,LTD., Drug intermediates 1,4,9(11)-pregnenetriene-16a-methyl-17a, 21-diol-3,20-dione-21-acetate synthesis method. 23 August 2018. Int. Cl. (2020.01) **C07J 5/00**.
-

Patents Granted Under Section 34

The number of a patent is given in heavy type; the letter S preceding the number indicates a short-term patent. The code numbers following the title of each invention are those of the International Patent Classification. The date of filing the application follows the proprietor's name. The patent application number, which follows the date of application in parenthesis, has been superseded by the patent number. In the case of an application claiming the priority of an earlier application, the name of the country where the earlier application was made and the date of the earlier application are shown in square brackets.

By virtue of Section 65(3), the application relating to any short-term patent appearing in the following list whose date of filing is later than the date which is 18 months prior to the date of this issue of the Journal becomes open to public inspection as and from the date of this issue of the Journal.

- 87087** Apparatus and method for gas and beer waste management. Int. Cl. (2020.01)
B67D 1/00. WALTER MARTIN BRADLEY 28 February 2017 (20170048)
[Ireland-02 March 2016]
-

Patents Granted Under European Patent Convention Designating Ireland

The Irish serial number appears first followed, respectively, by the proprietor's name, the date of filing of the application, the filing number and the European Patent Office publication number.

If the specification of the European patent was published in French or German the word 'French' or 'German', as appropriate, will appear as the last item of information.

Grants Published in EPO Bulletin No. 06/20, dated 05th February 2020

1963054	Newman, Robert D.	21/12/2006	1963054	06846757.0	
1964341	I-Comm Connect LLC	19/12/2006	1964341	06839416.2	
2092765	Cisco Technology, Inc.	07/12/2007	2092765	07865395.3	
2094839	University of Rochester	03/12/2007	2094839	07865112.2	
2095614	Vertiv Corporation	07/12/2007	2095614	07871662.8	
2106190	Huawei Technologies Co., Ltd.	29/08/2008	2106190	08800704.2	
2113143	Telefonaktiebolaget LM Ericsson (publ)	18/12/2007	2113143	07861121.7	
2118670	Analog Devices, Inc.	29/02/2008	2118670	08726261.4	
2136720	Western Clinical Engineering Ltd.	16/04/2008	2136720	08733758.0	
2187386	LG Electronics Inc.	06/12/2007	2187386	10001843.1	
2199543	United Technologies Corporation	17/12/2009	2199543	09252818.1	
2216116	Mafell AG	03/12/2009	2216116	09014993.1	German
2217862	Hombücher, Heinz-Dieter	04/12/2008	2217862	08856129.5	German
2220527	ADC Telecommunications, Inc.	09/12/2008	2220527	08858758.9	
2220900	Synapsense Corporation	12/12/2008	2220900	08860185.1	
2221837	JFE Steel Corporation	11/12/2008	2221837	08862237.8	
	TOYOTA JIDOSHA KABUSHIKI				
	KAISHA				
2222711	Teknologian tutkimuskeskus VTT Oy	17/12/2008	2222711	08865555.0	
2226399	Nippon Steel Corporation	11/12/2008	2226399	08859838.8	
2234749	Fraunhofer-Gesellschaft zur Förderung der angewandten Forschung e.V.	05/12/2008	2234749	08861632.1	German
2235483	Metering & Technology Limited	10/01/2008	2235483	08761750.2	French
2238529	Lattice Semiconductor Corporation	02/12/2008	2238529	08869587.9	
2238711	Microsoft Technology Licensing, LLC	09/12/2008	2238711	08869537.4	
2244958	RxSafe, LLC	19/12/2008	2244958	08866415.6	
2263145	NetApp, Inc.	11/02/2009	2263145	09710947.4	
2269131	Volkswagen Aktiengesellschaft	07/04/2009	2269131	09730850.6	German
2274500	Longyear TM, Inc.	15/05/2009	2274500	09747678.2	

2283166	Rio Tinto Alcan International Limited	02/06/2009	2283166	09761200.6	
2286180	KLA-Tencor Corporation	14/05/2009	2286180	09747614.7	
2289162	Lee, Olivia Pei-Hua Chang, Chun-Chieh	21/05/2009	2289162	09759000.4	
2298047	3M Innovative Properties Company	20/05/2009	2298047	09751434.3	
2298471	Applied Nanoparticle Laboratory Corporation	25/12/2008	2298471	08870788.0	
2299898	Canon Kabushiki Kaisha	10/07/2009	2299898	09787992.8	
2313202	Kellogg Brown & Root LLC	14/05/2009	2313202	09798225.0	
2315406	QUALCOMM Incorporated	22/05/2007	2315406	10189499.6	
2315722	Université de Lorraine	28/07/2009	2315722	09740398.4	French
2319243	Qualcomm Incorporated	10/07/2009	2319243	09790274.6	
2326116	Deutsche Telekom AG	20/11/2009	2326116	09176572.7	
2330769	Huawei Technologies Co., Ltd.	28/09/2009	2330769	09815637.5	
2333019	Silberline Manufacturing Company, Inc.	01/12/2010	2333019	10193355.4	
2337985	Solvay Fluor GmbH	22/10/2009	2337985	09744370.9	
2339560	Universal Electronics, Inc.	16/05/2003	2339560	11160539.0	
2347861	Mitsubishi Jidosha Kogyo Kabushiki Kaisha	20/12/2010	2347861	10195923.7	
2348187	EXTE GmbH	23/12/2010	2348187	10196765.1	German
2352803	LG Chem, Ltd.	03/12/2009	2352803	09831094.9	
2358804	The Coca-Cola Company	08/12/2009	2358804	09793376.6	
2359603	Semiconductor Components Industries, LLC	10/12/2009	2359603	09801318.8	
2361180	Essilor International	09/12/2009	2361180	09805692.2	
2362519	General Electric Company	22/02/2011	2362519	11155418.4	
2367921	Diversey, Inc.	01/12/2009	2367921	09760692.5	
2369270	LG Electronics Inc.	09/03/2011	2369270	11157424.0	
2370032	The Surgical Company International B.V.	23/12/2009	2370032	09775362.8	
2370135	Becton, Dickinson and Company	08/12/2009	2370135	09836477.1	
2370804	KSB SE & Co. KGaA	10/12/2009	2370804	09796950.5	German
2378129	Edwards Limited	23/09/2004	2378129	11169894.0	
2378214	LG Electronics Inc.	23/12/2009	2378214	09835261.0	
2378592	LG Chem, Ltd. Toray Industries, Inc.	15/12/2009	2378592	09836310.4	

2379646	Xyleco, Inc.	16/12/2009	2379646	09793676.9	
2383073	Mitsubishi Heavy Industries Machine Tool Co., Ltd.	16/12/2009	2383073	09834747.9	
2387645	Weavexx, LLC	10/02/2010	2387645	10704070.1	
2391290	Intuitive Surgical Operations, Inc.	17/12/2009	2391290	09801614.0	
2397859	F. Hoffmann-La Roche AG	15/06/2010	2397859	10165996.9	
2419479	Kwon, Sunghoon The Regents of the University of California	14/04/2010	2419479	10764767.9	
2421178	LG Electronics Inc.	07/12/2010	2421178	10836187.4	
2427456	F.HOFFMANN-LA ROCHE AG	28/04/2010	2427456	10715271.2	
2428016	BlackBerry Limited	30/04/2010	2428016	10719169.4	
2429090	China Mobile Communications Corporation	07/05/2010	2429090	10772035.1	
2435157	Woongjin Coway Co., Ltd.	31/12/2009	2435157	09845294.9	
2440586	Solvay Specialty Polymers Italy S.p.A.	10/06/2010	2440586	10725124.1	
2442771	Advanced Bio-Technologies, Inc.	18/06/2010	2442771	10790269.4	
2455543	Wirtgen GmbH	15/11/2011	2455543	11009045.3	German
2462874	Carl Freudenberg KG	10/12/2010	2462874	10015519.1	German
2463960	Schneider Electric Logistics Asia Pte Ltd.	08/12/2011	2463960	11009684.9	
2465581	Energenesis Biomedical Co., Ltd.	15/12/2010	2465581	10195263.8	
2466740	Dialog Semiconductor GmbH	14/12/2010	2466740	10368047.6	
2468433	United Technologies Corporation	22/12/2011	2468433	11195310.5	
2471007	F.HOFFMANN-LA ROCHE AG	25/08/2010	2471007	10749782.8	
2472099	SEG Automotive Germany GmbH	07/12/2011	2472099	11192290.2	German
2483661	Koninklijke Philips N.V.	24/09/2010	2483661	10765520.1	
2487330	General Electric Company	14/02/2012	2487330	12155466.1	
2487719	SEMICONDUCTOR ENERGY LABORATORY CO., LTD.	13/02/2012	2487719	12155050.3	
2491205	Nichols, John Alexander	25/10/2010	2491205	10824327.0	
2494525	Pictometry International Corp.	18/10/2010	2494525	10828764.0	
2495583	NEC Corporation	01/03/2012	2495583	12157685.4	
2506888	Oregon Health & Science University	03/12/2010	2506888	10835219.6	
2507706	Google LLC	02/12/2010	2507706	10796205.2	
2507799	Rapiscan Systems, Inc.	02/12/2010	2507799	10835160.2	
2509421	Cedars-Sinai Medical Center	10/12/2010	2509421	10836765.7	

2510084	The Board of Trustees of the University of Illinois	08/12/2010	2510084	10843462.2	
2511833	Google LLC	16/02/2007	2511833	12175775.1	
2512134	Clarion Co., Ltd.	07/12/2009	2512134	09852038.0	
2512749	Robert Bosch GmbH	18/10/2010	2512749	10770795.2	German
2512764	Husqvarna AB	16/12/2009	2512764	09852355.8	
2513475	LM Wind Power A/S	14/12/2010	2513475	10790961.6	
2513640	Phoenix, LLC	14/12/2010	2513640	10841534.0	
2513670	Saint-Gobain Ceramics & Plastics, Inc.	13/12/2010	2513670	10841509.2	
2513758	Comcast Cable Communications, LLC	03/12/2010	2513758	10838116.1	
2514122	ARRIS Enterprises LLC	08/12/2010	2514122	10793389.7	
2515921	Plant Bioscience Limited	23/12/2010	2515921	10801262.6	
2515991	Acist Medical Systems, Inc.	21/12/2010	2515991	10840059.9	
2516022	Marioff Corporation Oy	14/12/2010	2516022	10838742.4	
2516624	Merck Sharp & Dohme Corp.	16/12/2010	2516624	10839999.9	
2517108	Pivotal Software, Inc.	13/12/2010	2517108	10839989.0	
2517304	CommScope Technologies LLC	14/12/2010	2517304	10803668.2	
2517482	Sonova AG	22/12/2009	2517482	09795998.5	
2519284	Medtronic MiniMed, Inc.	16/12/2010	2519284	10798675.4	
2519727	Rolls-Royce Corporation	29/12/2010	2519727	10851161.9	
2521205	BlackBerry Limited	03/05/2012	2521205	12166589.7	
2522724	Chugai Seiyaku Kabushiki Kaisha	24/12/2010	2522724	10839561.7	
2524093	Välinge Innovation AB	23/12/2010	2524093	10843344.2	
2525276	TPK Touch Solutions Inc.	19/12/2011	2525276	11194175.3	
2525592	China Academy of Telecommunications Technology	11/01/2011	2525592	11731700.8	
2527079	Plus One Techno & Co., Ltd.	07/12/2010	2527079	10843838.3	
2527640	Yamaha Hatsudoki Kabushiki Kaisha	23/03/2012	2527640	12160899.6	
2530934	JVC KENWOOD Corporation	30/05/2012	2530934	12004153.8	
2532083	Huawei Technologies Co., Ltd.	03/12/2010	2532083	10860179.0	
2542834	IDEAL INDUSTRIES LIGHTING LLC	02/03/2011	2542834	11710348.1	
2543453	Korea Institute of Machinery and Materials	09/12/2009	2543453	09852089.3	
2544426	Canon Kabushiki Kaisha	06/07/2012	2544426	12175244.8	

2546934	China Aviation Optical-Electrical Technology Co., Ltd. Huawei Technologies Co., Ltd.	16/09/2011	2546934	11849320.4	
2549090	Stroganov, Alexander Anatolyevich	30/12/2010	2549090	10848072.4	
2549213	Miele & Cie. KG	29/06/2012	2549213	12401129.7	German
2550726	ZF Friedrichshafen AG	14/02/2011	2550726	11703670.7	German
2551126	Mitsubishi Pencil Company, Limited	23/03/2011	2551126	11759441.6	
2551396	Electrolux Home Products Corporation N.V.	27/07/2011	2551396	11175579.9	
2552379	Straumann Holding AG	11/03/2011	2552379	11708734.6	
2554494	Murata Machinery, Ltd.	02/04/2010	2554494	10849347.9	
2556304	BSH Hausgeräte GmbH	15/03/2011	2556304	11709912.7	German
2559905	ZIEHL-ABEGG SE	13/08/2012	2559905	12005842.5	German
2566131	Huawei Technologies Co., Ltd.	15/05/2008	2566131	12194157.9	
2581592	Isuzu Motors, Ltd.	10/06/2011	2581592	11792541.2	
2584312	TOYOTA JIDOSHA KABUSHIKI KAISHA	16/06/2010	2584312	10853230.0	
2587024	United Technologies Corporation	24/10/2012	2587024	12189781.3	
2592681	Panasonic Intellectual Property Management Co., Ltd.	04/07/2011	2592681	11803303.4	
2599311	Synaptics Incorporated Synaptics LLC	09/02/2011	2599311	11713514.5	
2604490	Steering Solutions IP Holding Corporation	12/12/2012	2604490	12196661.8	
2604588	General Electric Company	06/12/2012	2604588	12195942.3	
2604804	United Technologies Corporation	11/12/2012	2604804	12196594.1	
2604808	Nuovo Pignone S.p.A.	04/12/2012	2604808	12195529.8	
2604860	WILO SE	10/12/2012	2604860	12008222.7	German
2604878	SAFRAN Power UK Ltd.	07/12/2012	2604878	12196140.3	
2605071	Hewlett-Packard Development Company, L.P.	13/12/2012	2605071	12197015.6	
2605213	General Electric Company	04/12/2012	2605213	12195525.6	
2606927	Becton, Dickinson and Company	03/12/2010	2606927	13150403.7	
2607660	Rolls-Royce plc	17/12/2012	2607660	12197391.1	
2607668	Honeywell International Inc.	11/12/2012	2607668	12196589.1	
2607697	Nuovo Pignone S.p.A.	10/12/2012	2607697	12196357.3	
2608578	BlackBerry Limited	13/12/2012	2608578	12196890.3	

2613491	Vodafone Holding GmbH	05/12/2012	2613491	12195713.8	German
2615355	Hamilton Sundstrand Corporation	21/12/2012	2615355	12199089.9	
2615725	Diehl AKO Stiftung & Co. KG	13/12/2012	2615725	12008307.6	German
2616033	Hsr Hochschule Für Technik Rapperswil	08/08/2011	2616033	11749075.5	German
2617171	Telefonaktiebolaget LM Ericsson (publ)	09/08/2011	2617171	11754512.9	
2621656	Robert Bosch GmbH	04/08/2011	2621656	11739075.7	German
2627726	Lamberti Spa	06/05/2011	2627726	11721730.7	
2629219	Samsung Medison Co., Ltd.	04/12/2012	2629219	12195364.0	
2632098	Korea University Research and Business Foundation, Sejong Campus	20/10/2011	2632098	11834636.0	
2635643	PRC-Desoto International, Inc.	27/10/2011	2635643	11782705.5	
2638025	Deutsches Krebsforschungszentrum (DKFZ) Ruprecht-Karls-Universität Heidelberg	11/11/2011	2638025	11785375.4	
2645575	Canon Kabushiki Kaisha	05/03/2013	2645575	13157738.9	
2648521	Auburn University	12/12/2011	2648521	11799586.0	
2648593	S.C. Johnson & Son, Inc.	08/12/2011	2648593	11796906.3	
2648603	The Board of Regents of the University of Nebraska	08/12/2011	2648603	11846608.5	
2649005	SPTS Technologies Limited	07/12/2010	2649005	10860616.1	
2649029	Mohanty, Pravansu S. Ramesh, Swaminathan	08/12/2011	2649029	11847559.9	
2649234	Again IP B.V.	25/11/2011	2649234	11799251.1	
2649373	Société BIC	09/12/2010	2649373	10816311.4	
2649764	Telefonaktiebolaget LM Ericsson (publ)	09/12/2010	2649764	10860430.7	
2651281	Rug Doctor, LLC	15/12/2011	2651281	11848802.2	
2652483	General Electric Company	16/12/2011	2652483	11811014.7	
2652771	Norwegian University of Science and Technology (NTNU)	13/12/2011	2652771	11808613.1	
2653927	Canon Kabushiki Kaisha	21/03/2013	2653927	13160319.3	
2654923	Evonik Operations GmbH	19/12/2011	2654923	11804668.9	German
2655884	Debiotech S.A.	19/12/2011	2655884	11817419.2	
2655891	ebm-papst Mulfingen GmbH & Co. KG	16/12/2011	2655891	11807889.8	German
2655893	Silgan Dispensing Systems Corporation	21/12/2011	2655893	11851980.0	
2656019	Shustov, Andrey	20/12/2011	2656019	11811411.5	
2657343	TORAY INDUSTRIES, INC.	21/12/2011	2657343	11850267.3	

2657412	Doosan Infracore Co., Ltd.	26/12/2011	2657412	11850357.2	
2657538	Doosan Infracore Co., Ltd.	26/12/2011	2657538	11850467.9	
2658458	Neotract, Inc.	16/12/2011	2658458	11854148.1	
2661560	General Electric Company	06/12/2011	2661560	11802228.4	
2662447	Fraunhofer-Gesellschaft zur Förderung der angewandten Forschung e.V.	09/05/2012	2662447	12167377.6	German
2663394	Institut Polytechnique De Bordeaux (IPB) Université Bordeaux 1 Centre National de la Recherche Scientifique (C.N.R.S.)	15/12/2011	2663394	11817348.3	French
2667158	Continental Automotive Systems US, Inc.	23/05/2013	2667158	13168838.4	
2667531	Huawei Technologies Co., Ltd.	18/02/2013	2667531	13155620.1	
2680475	NXP B.V.	11/06/2013	2680475	13171493.3	
2684402	Panasonic Intellectual Property Corporation of America	06/12/2011	2684402	11811322.4	
2689364	Scully Signal Company	22/03/2012	2689364	12760459.3	
2690804	Siemens Aktiengesellschaft	26/07/2013	2690804	13178210.4	
2691178	Biosurfit, S.A.	28/03/2012	2691178	12716631.2	
2691248	Defense Products and Services Group, Inc.	02/04/2012	2691248	12765782.3	
2691272	Valeo Systèmes d'Essuyage	26/03/2012	2691272	12710289.5	French
2696268	Wacom Co., Ltd.	08/08/2013	2696268	13179675.7	
2696608	Deutsche Telekom AG	05/08/2013	2696608	13003886.2	
2697076	Välinge Innovation AB	12/04/2012	2697076	12771642.1	
2698914	Ricoh Company, Ltd.	14/08/2013	2698914	13180408.0	
2702822	Marvell World Trade Ltd.	27/04/2012	2702822	12719234.2	
2705645	Huawei Technologies Co., Ltd.	22/04/2013	2705645	13777738.9	
2708721	TOYOTA JIDOSHA KABUSHIKI KAISHA	12/05/2011	2708721	11807633.0	
2710834	Qualcomm Incorporated	16/05/2012	2710834	12724032.3	
2711381	SUN MEDICAL CO., LTD. Mitsui Chemicals, Inc. Shofu Inc.	11/05/2012	2711381	12785801.7	
2713458	NGK Spark Plug Co., Ltd.	24/09/2013	2713458	13185800.3	
2714506	Celtic Design Consultants Limited	08/05/2012	2714506	12719385.2	

2715815	Signify Holding B.V.	15/05/2012	2715815	12725511.5	
2716578	iie GmbH & Co. KG	05/10/2012	2716578	12187394.7	German
2716728	DIC Corporation Osaka City University	01/06/2012	2716728	12793415.6	
2716910	Wuhan Kaidi Engineering Technology Research Institute Co., Ltd.	23/05/2012	2716910	12789424.4	
2720063	ALSTOM Transport Technologies	12/10/2012	2720063	12188306.0	
2721724	Robert Bosch GmbH	01/06/2012	2721724	12725731.9	German
2721891	Samsung Electronics Co., Ltd.	15/06/2012	2721891	12800246.6	
2725409	Shanghai Tianma Micro-Electronics Co., Ltd.	07/12/2012	2725409	12876074.1	
2726884	Beckman Coulter, Inc.	27/06/2012	2726884	12738281.0	
2735832	Panasonic Intellectual Property Management Co., Ltd.	20/07/2012	2735832	12818246.6	
2736425	Marks, Michael, P. Que, Like	25/07/2012	2736425	12817411.7	
2738632	Rockwell Automation Technologies, Inc.	02/12/2013	2738632	13195286.3	
2739072	BlackBerry Limited	30/11/2012	2739072	12195002.6	
2740966	Siemens Aktiengesellschaft	05/12/2012	2740966	12195649.4	German
2741001	Ansaldo Energia S.p.A.	10/12/2013	2741001	13196562.6	
2741122	Oracle America, Inc.	29/03/2010	2741122	14158183.5	
2741477	BlackBerry Limited 2236008 Ontario Inc.	06/12/2012	2741477	12195962.1	
2743164	Yamaha Hatsudoki Kabushiki Kaisha	12/12/2013	2743164	13196776.2	
2743428	Spectralight Technologies, Inc.	16/12/2013	2743428	13197455.2	
2743476	General Electric Company	11/12/2013	2743476	13196614.5	
2743850	Samsung Electronics Co., Ltd.	17/12/2013	2743850	13197690.4	
2743863	Bancor SRL	02/12/2013	2743863	13195229.3	
2743896	ROSEMOUNT AEROSPACE INC.	13/12/2013	2743896	13197270.5	
2745426	Samsung Electronics Co., Ltd.	16/08/2012	2745426	12824026.4	
2745727	Wriedt Vermögensverwaltung GmbH & Co. KG	18/12/2013	2745727	13197912.2	German
2747231	Hamilton Sundstrand Corporation	09/12/2013	2747231	13196266.4	
2747267	General Electric Technology GmbH	18/12/2012	2747267	12275208.2	
2747474	Huawei Technologies Co., Ltd.	08/12/2012	2747474	12856776.5	
2748852	Teledyne e2v Semiconductors SAS	25/07/2012	2748852	12740947.2	French

2748864	Lumileds Holding B.V.	21/08/2012	2748864	12784063.5	
2749059	Telefonaktiebolaget LM Ericsson (publ)	27/12/2011	2749059	11878988.2	
2749346	Lotte Advanced Materials Co., Ltd. Lotte Chemical Corporation	27/12/2013	2749346	13199671.2	
2749378	Fipe AG	11/12/2013	2749378	13196703.6	German
2749407	Saint-Gobain Performance Plastics Corporation	20/12/2013	2749407	13199184.6	
2750383	HOYA Corporation	10/12/2013	2750383	13196472.8	
2751173	BAE Systems PLC	21/08/2012	2751173	12759805.0	
2755921	Aquasource Technologies Corporation	13/09/2012	2755921	12831074.5	
2757632	SPACE ENGINEERING S.p.A.	18/01/2013	2757632	13425011.7	
2762238	AERO Pump GmbH, Zerstäuberpumpen	03/12/2013	2762238	13195434.9	German
2763814	Illinois Tool Works Inc.	02/10/2012	2763814	12778550.9	
2763816	Husqvarna AB	06/10/2011	2763816	11873756.8	
2764789	Ehrhart, Hans Ehrhart, Peter	07/02/2014	2764789	14154311.6	German
2765020	SK Telecom. Co., Ltd.	20/04/2012	2765020	13170470.2	
2765445	Tridonic Jennersdorf GmbH	12/12/2013	2765445	13196842.2	German
2766878	Google LLC	19/09/2012	2766878	12839683.5	
2773809	Covestro Deutschland AG	02/11/2012	2773809	12783579.1	
2777026	Sony Corporation	03/10/2012	2777026	12847414.5	
2779709	Samsung Electronics Co., Ltd.	18/12/2013	2779709	13198163.1	
2785383	Dayton, Roderick M. Diversey, Inc.	29/11/2012	2785383	12853114.2	
2785683	Ludwig Institute for Cancer Research Ltd.	30/11/2012	2785683	12798262.7	
2787542	LG Innotek Co., Ltd.	02/12/2010	2787542	14169174.1	
2788370	The Regents of the University of California	06/12/2012	2788370	12856566.0	
2788379	X-Body, Inc.	05/12/2012	2788379	12856569.4	
2788826	Cartier International AG	04/12/2012	2788826	12812339.5	French
2788953	Electronic Arts Inc.	07/12/2012	2788953	12855275.9	
2789012	Sofics BVBA	07/12/2012	2789012	12808290.6	
2789092	TM4 Inc.	05/12/2012	2789092	12856190.9	
2789379	LG Chem, Ltd.	07/12/2012	2789379	12854843.5	
2790239	Idemitsu Kosan Co., Ltd	04/12/2012	2790239	12855216.3	

2791046	Strauss Water Ltd.	04/12/2012	2791046	12816138.7	
2791097	Université Paris-Sud XI	11/12/2012	2791097	12816705.3	French
2791264	Samsung Electronics Co., Ltd.	06/12/2012	2791264	12858552.8	
2791489	Siemens Energy, Inc.	07/12/2012	2791489	12861047.4	
2791702	Northrop Grumman Guidance and Electronics Company, Inc.	13/12/2012	2791702	12857755.8	
2792217	IDEAL INDUSTRIES LIGHTING LLC	12/12/2012	2792217	12857650.1	
2792709	Bridgestone Corporation	10/12/2012	2792709	12858665.8	
2793875	EMMAUS MEDICAL, INC.	14/12/2012	2793875	12860587.0	
2794226	Compagnie Plastic Omnium Institut National des Sciences Appliquées de Lyon Université Claude Bernard Lyon 1	21/12/2012	2794226	12818799.4	French
2794347	Carrier Corporation	13/12/2012	2794347	12809940.5	
2795084	Ansaldo Energia IP UK Limited	14/12/2012	2795084	12810186.2	
2795818	Orange	20/12/2012	2795818	12819103.8	French
2796036	Unicharm Corporation	18/12/2012	2796036	12859757.2	
2798728	TA Instruments-Waters LLC	10/12/2012	2798728	12809916.5	
2798812	ABB Schweiz AG	20/12/2012	2798812	12808259.1	
2799728	Mitsubishi Heavy Industries, Ltd.	17/12/2012	2799728	12861083.9	
2802133	Noetica Ltd	12/05/2014	2802133	14250073.5	
2802199	Samsung Electronics Co., Ltd.	29/04/2014	2802199	14166455.7	
2802786	HILTI Aktiengesellschaft	05/12/2012	2802786	12795448.5	German
2805728	Genentech, Inc.	23/12/2004	2805728	14164624.0	
2806321	Mitsubishi Hitachi Power Systems, Ltd.	27/02/2009	2806321	14166584.4	
2808297	Commissariat à l'Énergie Atomique et aux Énergies Alternatives	26/05/2014	2808297	14169829.0	French
2809611	proionic GmbH	20/12/2012	2809611	12812622.4	
2812192	Sanford, L. P.	20/12/2012	2812192	12818964.4	
2813107	NEC Corporation	05/11/2012	2813107	12867923.0	
2813180	Nihon Kohden Corporation	09/05/2014	2813180	14167610.6	
2816936	Schaerer AG	12/02/2013	2816936	13705951.5	German
2817932	Lattice Semiconductor Corporation	22/02/2013	2817932	13751229.9	
2818111	Toyota Jidosha Kabushiki Kaisha	24/02/2012	2818111	12869198.7	
2818814	Samsung Electronics Co., Ltd.	22/05/2014	2818814	14169373.9	
2819299	Kabushiki Kaisha Yaskawa Denki	22/02/2012	2819299	12868933.8	

2822467	Koninklijke Philips N.V.	06/02/2013	2822467	13711969.9	
2822640	DEKA Products Limited Partnership	07/03/2013	2822640	13757470.3	
2822692	Galloo Plastics	04/03/2013	2822692	13712308.9	French
2824564	Sony Corporation	27/06/2014	2824564	14174730.3	
2825563	Nanovelos S.A.	12/03/2013	2825563	13712947.4	
2828490	Safran Nacelles	19/03/2013	2828490	13719903.0	French
2831983	General Electric Technology GmbH	25/03/2013	2831983	13711905.3	
2832148	Nokia Solutions and Networks Oy	30/03/2012	2832148	12711193.8	
2832230	Nissin Foods Holdings Co., Ltd.	18/03/2013	2832230	13768532.7	
2836982	R. R. Donnelley & Sons Company	05/03/2013	2836982	13710733.0	
2839098	Senvion GmbH	03/04/2013	2839098	13716202.0	German
2840909	HBC Holding Company, LLC	07/12/2011	2840909	11877020.5	
2841134	Vigmed AB	26/04/2013	2841134	13782410.8	
2842954	Samsung SDI Co., Ltd.	18/12/2012	2842954	12875420.7	
2847854	Siemens Energy, Inc.	10/05/2013	2847854	13725864.6	
2848090	Regan, Matthew	06/05/2013	2848090	13724965.2	
	Grove, Elisa Katar				
	Bastien, Valerie A.				
	Oostdyk, Mark Andrew				
	Lighting Science Group Corporation				
	Maxik, Fredric S.				
	Soler, Robert R.				
	Bartine, David E.				
2848866	Electrolux Appliances Aktiebolag	17/09/2013	2848866	13184801.2	
2850144	Tecnologic 3 S.r.l.	18/05/2012	2850144	12731153.8	
2851677	Gerresheimer Bünde GmbH	23/09/2013	2851677	13004613.9	German
2852574	Hetero Research Foundation	21/05/2013	2852574	13793172.1	
2857343	Sööt, Olaf	01/10/2013	2857343	13186985.1	
2858394	Vodafone GmbH	06/10/2014	2858394	14187817.3	German
2860456	BSH Hausgeräte GmbH	24/09/2014	2860456	14186215.1	
2866159	Samsung Electronics Co., Ltd.	17/09/2014	2866159	14185220.2	
2868426	Siemens Energy, Inc.	22/10/2014	2868426	14189865.0	
2869139	Chronométrie Ferdinand Berthoud	04/11/2013	2869139	13191467.3	French
2872097	Glatfelter Falkenhagen GmbH	12/07/2013	2872097	13735317.3	

2872947	Simoni, Michael Butler, Gary Deighton, Robert Sun Chemical Corporation	12/07/2013	2872947	13816891.9	
2873225	Tencent Technology (Shenzhen) Company Limited	27/05/2013	2873225	13817241.6	
2875355	Indiana University Research and Technology Corporation	22/07/2013	2875355	13823641.9	
2878448	Seiko Epson Corporation	26/11/2014	2878448	14195031.1	
2878476	Plastic Components and Modules Automotive S.p.A.	16/10/2014	2878476	14189169.7	
2880116	EVERTREE	30/07/2013	2880116	13824739.0	
2881240	The Boeing Company	03/12/2014	2881240	14196023.7	
2881748	Rockwell Automation Technologies, Inc.	03/12/2014	2881748	14196030.2	
2882155	Huawei Technologies Co., Ltd.	02/08/2012	2882155	12882146.9	
2882160	Vodafone Holding GmbH	05/12/2014	2882160	14196530.1	German
2883764	Valeo Systèmes d'Essuyage	15/12/2014	2883764	14197848.6	French
2884489	Harman Becker Automotive Systems GmbH	16/12/2013	2884489	13197399.2	
2884523	IMEC VZW Katholieke Universiteit Leuven	16/12/2013	2884523	13197472.7	
2887014	EM Microelectronic-Marin SA	19/12/2013	2887014	13198518.6	French
2887201	LG Electronics Inc.	09/12/2014	2887201	14197044.2	
2887517	Siemens Aktiengesellschaft	23/12/2013	2887517	13199294.3	
2887769	Securlite	16/12/2014	2887769	14198369.2	French
2889127	Airbus Operations S.L.	27/12/2013	2889127	13382565.3	
2889214	Airbus Operations, S.L.	31/12/2013	2889214	13382581.0	
2889712	Fisher-Rosemount Systems, Inc.	05/12/2006	2889712	15152084.8	
2890120	Telefonaktiebolaget LM Ericsson (publ)	17/12/2014	2890120	14004254.0	
2891140	Signify Holding B.V.	27/08/2013	2891140	13785622.5	
2892212	Samsung Electronics Co., Ltd.	09/12/2014	2892212	14197039.2	
2893397	Eastman Kodak Company	27/08/2013	2893397	13759637.5	
2895391	Safran Aircraft Engines	12/09/2013	2895391	13773289.7	French
2899985	Sony Corporation	06/09/2013	2899985	13839399.6	
2901076	Schott AG	26/09/2013	2901076	13770466.4	German

2901427	Giesecke+Devrient Currency Technology GmbH	27/09/2013	2901427	13770840.0	German
2902112	Flottweg SE	12/12/2014	2902112	14197610.0	German
2910290	MANN + HUMMEL GMBH	04/12/2014	2910290	14196222.5	German
2911388	NEC Corporation	15/08/2013	2911388	13846298.1	
2912924	Signify Holding B.V.	24/10/2013	2912924	13820891.3	
2915197	Lumileds Holding B.V.	22/10/2013	2915197	13821954.8	
2915857	Mitsuboshi Belting Ltd.	21/12/2012	2915857	12887449.2	
2918345	Andritz S.A.S.	14/03/2014	2918345	14000941.6	
2921444	Ricoh Company, Ltd.	09/03/2015	2921444	15158280.6	
2921520	Dai-Ichi Kogyo Seiyaku Co., Ltd.	13/12/2013	2921520	13864231.9	
2921871	General Electric Technology GmbH	20/03/2014	2921871	14160881.0	
2922590	Amgen Inc.	20/11/2013	2922590	13802787.5	
2923149	Siemens Aktiengesellschaft	03/12/2013	2923149	13799059.4	German
2923517	Telefonaktiebolaget LM Ericsson (publ)	20/11/2012	2923517	12799658.5	
2923975	Segbert GmbH & Co. KG	26/03/2014	2923975	14161669.8	German
2925885	Almac Diagnostic Services Limited	03/12/2013	2925885	13808178.1	
2926109	Dockon AG	03/12/2013	2926109	13860466.5	
2926495	Telefonaktiebolaget LM Ericsson (publ)	02/12/2013	2926495	13817762.1	
2928422	Medtronic Ardian Luxembourg S.à.r.l.	04/12/2013	2928422	13812319.5	
2928742	Deif A/S	05/12/2013	2928742	13811352.7	
2929013	Stembios Technologies, Inc.	05/12/2013	2929013	13860895.5	
2929190	Nuovo Pignone S.r.l.	02/12/2013	2929190	13801526.8	
2929445	Joyson Safety Systems Acquisition LLC	06/12/2013	2929445	13860801.3	
2929586	Massachusetts Institute of Technology	04/12/2013	2929586	13876444.4	
2929673	Orange	03/12/2013	2929673	13808143.5	French
2929691	Sonos, Inc.	03/12/2013	2929691	13861006.8	
2929692	Saronikos Trading and Services, Unipessoal Lda	06/12/2012	2929692	12795831.2	
2930170	Kyowa Kirin Co., Ltd.	06/12/2013	2930170	13860161.2	
2930233	Kawasaki Jukogyo Kabushiki Kaisha	06/12/2013	2930233	13860856.7	
2930319	Panasonic Intellectual Property Management Co., Ltd.	03/12/2013	2930319	13860087.9	
2930728	Asahi Kasei Kabushiki Kaisha	05/12/2013	2930728	13860736.1	
2931266	Metabolys	17/12/2013	2931266	13815459.6	French
2931722	Arrien Pharmaceuticals LLC	10/12/2013	2931722	13862263.4	

2931751	Arch Oncology, Inc.	12/12/2013	2931751	13863325.0	
2932192	The Regents of the University of California	12/12/2013	2932192	13863507.3	
2932230	UC-Care Ltd.	17/12/2013	2932230	13865973.5	
2932248	Aktiebolaget SKF	17/12/2012	2932248	12813305.5	
2932543	VARTA Microbattery GmbH	11/12/2013	2932543	13802666.1	German
2932625	Huawei Technologies Co., Ltd.	13/12/2013	2932625	13862840.9	
2932626	Samsung Electronics Co., Ltd.	05/12/2013	2932626	13861709.7	
2932633	SAGEMCOM BROADBAND SAS	04/12/2013	2932633	13801547.4	French
2934121	Novapharm Research (Australia) Pty Ltd	19/12/2013	2934121	13867548.3	
2934593	Softkemo Pharma Corp.	23/12/2013	2934593	13874815.7	
2934818	Atlas Copco Industrial Technique AB	11/12/2013	2934818	13802405.4	
2934861	Vestas Wind Systems A/S	19/12/2013	2934861	13811363.4	
2934936	AGCO International GmbH	23/12/2013	2934936	13830082.7	
2935355	Inovyn Europe Limited	19/12/2013	2935355	13814908.3	French
2935895	ITT Manufacturing Enterprises LLC	17/12/2013	2935895	13829054.9	
2936782	Orange	16/12/2013	2936782	13818311.6	French
2937394	Tokyo Printing Ink Mfg. Co., Ltd.	18/12/2013	2937394	13866228.3	
2938188	Remmal, Adnane	31/12/2013	2938188	13830233.6	French
2938463	Saint-Gobain Abrasives, Inc. Saint-Gobain Abrasifs	19/12/2013	2938463	13868740.5	
2938553	GE HEALTHCARE AS	27/12/2013	2938553	13868359.4	
2938696	Nederlandse Organisatie voor toegepast- natuurwetenschappelijk onderzoek TNO	24/12/2013	2938696	13818521.0	
2938830	United Technologies Corporation	06/12/2013	2938830	13869557.2	
2938836	United Technologies Corporation	23/12/2013	2938836	13867264.7	
2938842	United Technologies Corporation	16/12/2013	2938842	13876419.6	
2939009	BERKIN B.V.	24/12/2013	2939009	13824408.2	
2939321	Koki Holdings Co., Ltd.	25/12/2013	2939321	13821201.4	
2939469	Sony Corporation	25/10/2013	2939469	13789627.0	
2940066	Spiber Inc.	17/12/2013	2940066	13867491.6	
2940143	Evonik Operations GmbH	30/04/2014	2940143	14166633.9	German
2940268	Doosan Infracore Co., Ltd.	26/12/2013	2940268	13866707.6	
2940275	Doosan Infracore Co., Ltd.	13/12/2013	2940275	13868718.1	
2941040	LG Electronics Inc.	30/12/2013	2941040	13866702.7	

2943961	Carl Zeiss SMT GmbH	06/12/2013	2943961	13799616.1	
2945020	Canon Kabushiki Kaisha	15/05/2015	2945020	15167804.2	
2945134	Kum Oh Electronics Co., Ltd	23/12/2013	2945134	13871257.5	
2945873	Precision Valve Corporation	18/12/2013	2945873	13864111.3	
2946386	Micron Technology, Inc.	13/12/2013	2946386	13871702.0	
2947446	Osaka University	24/12/2013	2947446	13871806.9	
2948086	BOWA-electronic GmbH & Co. KG	20/01/2014	2948086	14703785.7	German
2948931	Tyco Safety Products Canada Ltd.	10/12/2013	2948931	13873075.9	
2949291	Kirsch, Hinnerk	02/12/2014	2949291	14195866.0	German
2952091	THE Machines Yvonand SA	05/06/2014	2952091	14171418.8	German
2955212	Mitsui Chemicals, Inc.	06/02/2014	2955212	14749347.2	
2955942	Huawei Technologies Co., Ltd.	06/12/2013	2955942	13876114.3	
2956293	Harburg-Freudenberger Maschinenbau GmbH	05/02/2014	2956293	14713752.5	German
2958437	Direvo Industrial Biotechnology GmbH BASF Enzymes, LLC	21/03/2013	2958437	13711367.6	
2959433	Beckman Coulter, Inc.	14/02/2014	2959433	14711031.6	
2959578	Qualcomm Incorporated	10/02/2014	2959578	14706227.7	
2960134	ALSTOM Transport Technologies	30/08/2011	2960134	15175255.7	
2960518	Torishima Pump Mfg. Co., Ltd.	27/03/2015	2960518	15161477.3	
2961023	Hitachi, Ltd.	25/02/2013	2961023	13875557.4	
2962338	Universal Display Corporation	09/06/2010	2962338	10728963.9	
2963361	Kabushiki Kaisha Toyota Chuo Kenkyusho	27/02/2015	2963361	15156939.9	
2964119	Warsaw Orthopedic, Inc.	24/02/2014	2964119	14760186.8	
2964799	Arconic Inc.	06/03/2014	2964799	14778249.4	
2966504	IMS Nanofabrication GmbH	06/07/2015	2966504	15175373.8	
2967505	Longboat Amniotics AB	14/03/2014	2967505	14752368.2	
2971299	Rolls-Royce Corporation	30/12/2013	2971299	13826700.0	
2971587	Rolls-Royce Corporation	31/12/2013	2971587	13824458.7	
2974196	Samsung Electronics Co., Ltd.	10/03/2014	2974196	14763029.7	
2976478	Poseidon GT S.R.L.	21/03/2014	2976478	14722339.0	
2977420	Zeon Corporation	13/03/2014	2977420	14768146.4	
2979008	Deere & Company	20/03/2014	2979008	14728618.1	German
2979479	Huawei Technologies Co., Ltd.	28/03/2013	2979479	13713850.9	
2980326	Doosan Infracore Co., Ltd.	28/03/2014	2980326	14776506.9	
2981308	Cytosorbents Corporation	31/03/2014	2981308	14779243.6	

2981557	Aziende Chimiche Riunite Angelini Francesco A.C.R.A.F. S.p.A.	31/03/2014	2981557	14713507.3	
2983304	LG Electronics Inc.	27/12/2013	2983304	13881340.7	
2984164	Advanced Regen Medical Technologies, LLC	09/04/2014	2984164	14782619.2	
2985895	Huawei Technologies Co., Ltd.	06/05/2014	2985895	14865359.5	
2987242	InvenSense, Inc.	28/02/2014	2987242	14775783.5	
2987769	BASF SE	19/08/2014	2987769	14002871.3	German
2988365	Sony Semiconductor Solutions Corporation	27/03/2014	2988365	14785444.2	
2989554	LeoNovus USA	24/04/2014	2989554	14788926.5	
2990660	Rolls-Royce plc	24/08/2015	2990660	15182102.2	
2991037	Tsinghua University	25/12/2013	2991037	13883238.1	
2992633	Telefonaktiebolaget LM Ericsson (publ)	20/09/2013	2992633	13779405.3	
2993455	Yokogawa Electric Corporation	31/08/2015	2993455	15183170.8	
2993687	Versum Materials US, LLC	14/08/2015	2993687	15181146.0	
2994412	Murata Manufacturing Co., Ltd.	08/05/2014	2994412	14732382.8	
2995659	Mitsubishi Pencil Co., Ltd.	23/04/2014	2995659	14794728.7	
2997108	Signify Holding B.V.	06/05/2014	2997108	14721852.3	
3000287	Thermacut, k.s.	22/05/2014	3000287	14732071.7	
3002454	Hollick Solar Systems Limited	31/10/2014	3002454	14191384.8	
3004288	Lubrizol Advanced Materials, Inc.	23/05/2014	3004288	14732746.4	
3006535	Idemitsu Kosan Co., Ltd	27/05/2014	3006535	14805049.5	
3008330	HAN, Kyung Soo Differential Dynamics Corporation	25/04/2014	3008330	14810755.0	
3009010	PureCircle SDN BHD The Coca-Cola Company	19/12/2012	3009010	15188255.2	
3009135	INSERM (Institut National de la Santé et de la Recherche Médicale)	03/12/2007	3009135	15175719.2	
3009633	Mitsubishi Heavy Industries, Ltd.	30/06/2014	3009633	14849505.4	
3010910	MyoKardia, Inc.	19/06/2014	3010910	14738986.0	
3012576	4d Sensor Inc.	30/06/2014	3012576	14896657.5	
3012598	Hitachi Automotive Systems, Ltd.	07/02/2014	3012598	14813159.2	
3013056	Sun Patent Trust	16/06/2014	3013056	14813446.3	
3014123	Eaton Corporation	27/06/2014	3014123	14818247.0	
3015560	Kabushiki Kaisha Riken	26/05/2014	3015560	14818704.0	
3015880	NXP B.V.	23/10/2015	3015880	15191207.8	

3016257	Posco Energy Co. Ltd.	20/06/2014	3016257	14818167.0	
3018737	Hangzhou MPower New Energy Technology Co., Ltd.	23/10/2015	3018737	15191267.2	
3020980	Daikin Industries, Ltd.	07/07/2014	3020980	14822776.2	
3021206	Huawei Technologies Co., Ltd.	17/06/2014	3021206	14822408.2	
3022205	The Trustees of Columbia University in the City of New York	17/07/2014	3022205	14826002.9	
3022459	Grass GmbH	26/06/2014	3022459	14736332.9	German
3022864	Qualcomm Incorporated	07/07/2014	3022864	14809146.5	
3026456	LG Electronics Inc.	17/07/2014	3026456	14829084.4	
3028920	Siemens Rail Automation S.A.U.	19/12/2014	3028920	14380039.9	
3029591	Xiaomi Inc.	04/12/2015	3029591	15198096.8	
3029596	Lookingglass Cyber Solutions, Inc.	01/12/2015	3029596	15197292.4	
3029634	AmCad BioMed Corporation	01/12/2014	3029634	14195578.1	
3029857	Kuang-chi Innovative Technology Ltd.	06/06/2014	3029857	14831951.0	
3031554	JPW Industries Inc.	07/12/2015	3031554	15198269.1	
3031565	The Boeing Company	16/12/2014	3031565	15200550.0	
3031597	Recticel	12/12/2014	3031597	14197795.9	
3031664	Britax Römer Kindersicherheit GmbH	10/12/2014	3031664	14004159.1	
3032175	United Technologies Corporation	14/12/2015	3032175	15199825.9	
3032201	Liebherr-Hausgeräte Ochsenhausen GmbH	09/12/2015	3032201	15198707.0	German
3032232	Kidde Technologies, Inc.	08/12/2015	3032232	15198496.0	
3032650	ThinKom Solutions, Inc.	10/12/2015	3032650	15199288.0	
3032763	Viavi Solutions Inc.	04/12/2015	3032763	15198092.7	
3032845	GN Hearing A/S	12/12/2014	3032845	14197819.7	
3032899	Samsung Electronics Co., Ltd. Korea University Research and Business Foundation	11/12/2015	3032899	15199510.7	
3033258	Siemens Mobility GmbH	29/08/2014	3033258	14761820.1	German
3033834	MediaTek Inc.	31/07/2015	3033834	15790809.6	
3034149	General Electric Technology GmbH	17/12/2014	3034149	14198418.7	
3034386	MPR GmbH & Co. KG	18/12/2015	3034386	15201286.0	German
3034481	Asahi Kasei Kabushiki Kaisha	08/08/2014	3034481	14836672.7	
3034712	Corstyrene	15/12/2015	3034712	15200220.0	French
3034811	United Technologies Corporation	15/12/2015	3034811	15200038.6	
3035054	Fenwal, Inc.	16/12/2015	3035054	15200464.4	

3035623	Alcatel Lucent	19/12/2014	3035623	14307102.5	
3036074	Gebrüder Linck GmbH & Co. KG "Gatterlinck" Maschinenfabrik	14/08/2014	3036074	14752312.0	German
3036819	MediaTek Inc.	16/12/2014	3036819	14861103.1	
3036887	Qualcomm Incorporated	15/08/2014	3036887	14758454.4	
3037237	Cannon S.p.A.	17/12/2015	3037237	15200862.9	
3037627	United Technologies Corporation	18/12/2015	3037627	15201381.9	
3037736	GD Midea Heating & Ventilating Equipment Co., Ltd. Midea Group Co., Ltd.	17/09/2015	3037736	15185628.3	
3037827	Omron Corporation	18/07/2014	3037827	14838744.2	
3039451	Trimble Inc.	22/08/2014	3039451	14766030.2	
3039605	Intel Corporation	28/08/2013	3039605	13892618.3	
3039917	Qualcomm Incorporated	22/08/2014	3039917	14762149.4	
3040517	United Technologies Corporation	22/12/2015	3040517	15202175.4	
3040583	United Technologies Corporation	08/12/2015	3040583	15198498.6	
3040715	Valmet Technologies Oy	15/12/2015	3040715	15397544.6	
3040967	Xiaomi Inc.	31/12/2015	3040967	15203246.2	
3040972	LG Display Co., Ltd.	03/12/2015	3040972	15197724.6	
3041379	NIKE Innovate C.V.	23/06/2014	3041379	14741724.0	
3042006	Hulleman, Jacob	05/09/2014	3042006	14792613.3	
3042259	Panduit Corp	03/09/2014	3042259	14767217.4	
3042301	Huawei Technologies Co., Ltd.	28/09/2014	3042301	14853119.7	
3043043	MANN + HUMMEL GMBH	14/12/2015	3043043	15199755.8	German
3043492	Imagination Technologies Limited	24/12/2015	3043492	15202726.4	
3043640	Biofishency Ltd	02/12/2014	3043640	14868407.9	
3045910	Fraunhofer-Gesellschaft zur Förderung der angewandten Forschung e.V. Technische Universität Dresden	29/12/2015	3045910	15202915.3	German
3046957	United Technologies Corporation	11/09/2014	3046957	14846455.5	
3048588	Alps Alpine Co., Ltd.	15/12/2015	3048588	15200184.8	
3048630	Siemens Aktiengesellschaft	04/12/2015	3048630	15198047.1	German
3050066	Maschinenfabrik Reinhausen GmbH	26/09/2014	3050066	14776645.5	German
3050638	Hitachi Metals, Ltd.	28/08/2014	3050638	14849491.7	
3051824	Velos Media International Limited	21/12/2012	3051824	16161035.7	
3052696	Saint-Gobain Adfors	29/09/2014	3052696	14796211.2	French
3057498	California Institute of Technology	17/10/2014	3057498	14853368.0	

3058603	ROYAL MELBOURNE INSTITUTE OF TECHNOLOGY	30/09/2014	3058603	14853674.1	
3059168	Hamilton Sundstrand Corporation	02/12/2015	3059168	15197576.0	
3060810	Williams International Co., L.L.C.	21/10/2014	3060810	14792705.7	
3061564	Optotech Optikmaschinen GmbH	21/12/2015	3061564	15201656.4	German
3061840	POSCO	24/12/2013	3061840	13896046.3	
3061949	Rolls-Royce PLC	07/12/2015	3061949	15198190.9	
3062090	AIT Austrian Institute of Technology GmbH	05/02/2016	3062090	16154387.1	German
3062618	Kala Pharmaceuticals, Inc.	31/10/2014	3062618	14857737.2	
3062738	Colgate-Palmolive Company	17/12/2014	3062738	14824698.6	
3062755	3M Innovative Properties Company	29/10/2014	3062755	14799615.1	
3063197	Dow Global Technologies LLC	21/10/2014	3063197	14792702.4	
3063481	Arçelik Anonim Sirketi	31/10/2013	3063481	13785467.5	
3064236	Bigfoot Biomedical, Inc.	08/11/2006	3064236	16152766.8	
3064585	The Broad Institute, Inc. Massachusetts Institute of Technology President and Fellows of Harvard College	12/12/2013	3064585	16151694.3	
3064691	dormakaba Deutschland GmbH	29/12/2015	3064691	15203030.0	German
3065518	Nitto Denko Corporation	10/10/2014	3065518	14858454.3	
3065993	Siemens Mobility GmbH	12/12/2014	3065993	14824394.2	German
3066304	MBDA France	04/11/2014	3066304	14808517.8	
3068262	Colgate-Palmolive Company	05/12/2013	3068262	13812332.8	
3069022	Ricardo Uk Limited	17/11/2014	3069022	14812875.4	
3069467	Parmar, Varun Hrebicek, Ondrej Doermann, Matthew Levine, Brian, W. Verma, Ashwani, Kumar Kronrod, Alex EMC Corporation	19/12/2014	3069467	14876123.2	
3070644	Kapsch TrafficCom AG	20/03/2015	3070644	15160046.7	
3071205	Forma Therapeutics, Inc.	18/11/2014	3071205	14862659.1	
3071898	Ariston Thermo S.p.A.	07/11/2014	3071898	14809509.4	
3072196	Reichle & De-Massari AG	05/11/2014	3072196	14796739.2	German
3073227	Oxsensis Ltd	12/12/2008	3073227	16167750.5	

3073684	Juniper Networks, Inc.	18/12/2012	3073684	16164192.3	
3074639	Safran Aircraft Engines	24/11/2014	3074639	14821734.2	French
3074669	Baker Hughes, a GE company, LLC	21/10/2014	3074669	14866491.5	
3075060	LG Electronics Inc.	01/12/2014	3075060	14866763.7	
3076730	Huawei Technologies Co., Ltd.	20/12/2013	3076730	13899427.2	
3076808	Philip Morris Products S.A.	04/12/2014	3076808	14806331.6	
3076884	Heartware, Inc.	04/12/2014	3076884	14867008.6	
3076957	Orion Corporation	05/12/2014	3076957	14819038.2	
3077058	L'Oréal	02/12/2014	3077058	14805919.9	
3077085	Johnson Matthey Public Limited Company	08/12/2014	3077085	14825207.5	
3077144	Rosjoh Pty Ltd	02/12/2014	3077144	14867706.5	
3077314	Otis Elevator Company	05/12/2013	3077314	13898768.0	
3077374	FMC Corporation	02/12/2014	3077374	14815174.9	
3077596	Omega Trestle LLC	02/12/2014	3077596	14867128.2	
3077603	Eutherm Sp. z o.o.	02/12/2014	3077603	14827539.9	
3077709	FARREL CORPORATION	02/12/2013	3077709	13808397.7	
3077722	King Abdullah University of Science and Technology	04/12/2014	3077722	14867643.0	
3077755	Zehnder Group International AG	04/12/2014	3077755	14835667.8	German
3077818	Katholieke Universiteit Leuven Prometheus Biosciences, Inc.	02/12/2014	3077818	14815062.6	
3078067	Solarpaint Ltd.	08/12/2014	3078067	14824547.5	
3078446	Hiroshima University	01/12/2014	3078446	14868323.8	
3079324	Huawei Technologies Co., Ltd.	31/12/2013	3079324	13900689.4	
3079345	Blackmagic Design Party Limited	08/04/2016	3079345	16164484.4	
3079434	Samsung Electronics Co., Ltd.	04/12/2014	3079434	14854889.4	
3079549	Essity Hygiene and Health Aktiebolag	09/12/2013	3079549	13899292.0	
3079658	Defymed	09/12/2014	3079658	14809630.8	
3079762	Heraeus Deutschland GmbH & Co. KG	10/12/2014	3079762	14816420.5	
3079772	Merck Sharp & Dohme Corp.	08/12/2014	3079772	14870360.6	
3079787	Novasep Process	09/12/2014	3079787	14809046.7	French
3079788	Novasep Process	09/12/2014	3079788	14815609.4	French
3079965	Siemens Mobility Austria GmbH	05/12/2014	3079965	14816147.4	German
3080170	Transfert Plus, S.E.C.	12/12/2014	3080170	14869856.6	
3080656	Carl Zeiss Microscopy GmbH	03/12/2014	3080656	14812160.1	German
3080708	Marvell World Trade Ltd.	09/12/2014	3080708	14821028.9	

3080915	Ooma Inc.	03/12/2014	3080915	14870084.2	
3081508	Blisspack Co., Ltd.	10/12/2014	3081508	14870279.8	
3082565	Essilor International	12/12/2014	3082565	14827506.8	French
3082713	Colgate-Palmolive Company	20/12/2013	3082713	13821330.1	
3082723	Colgate-Palmolive Company	10/12/2014	3082723	14821411.7	
3082805	Institute for Drug Discovery, LLC	19/12/2014	3082805	14871777.0	
3082903	Rx Bandz, LLC	16/12/2014	3082903	14871591.5	
3082973	Colgate-Palmolive Company	20/12/2013	3082973	13821329.3	
3082974	L'OREAL	19/12/2014	3082974	14833312.3	
3083115	United Technologies Corporation	03/12/2014	3083115	14870825.8	
3083163	BIC-Violex S.A.	18/12/2013	3083163	13815471.1	
3083807	Compagnie Générale des Etablissements Michelin	19/12/2014	3083807	14815370.3	French
3084011	Grede LLC	19/12/2014	3084011	14872378.6	
3084179	United Technologies Corporation	12/12/2014	3084179	14883879.0	
3084547	Xip Technology AB	16/12/2014	3084547	14871301.9	
3084574	Samsung Electronics Co., Ltd.	16/12/2014	3084574	14871617.8	
3084664	Martin, Florian Talikka, Marja Philip Morris Products S.A.	11/12/2014	3084664	14818928.5	
3084854	Oxford University Innovation Limited	17/12/2014	3084854	14815818.1	
3085046	Telefonaktiebolaget LM Ericsson (publ)	20/12/2013	3085046	13826784.4	
3085151	Telefonaktiebolaget LM Ericsson (publ)	02/12/2014	3085151	14808583.0	
3086477	Yulong Computer Telecommunication Scientific (Shenzhen) Co. Ltd.	21/12/2013	3086477	13899889.3	
3086981	Puchkoff, Jerome	24/12/2014	3086981	14874678.7	
3087369	Saturas Ltd.	23/12/2014	3087369	14875195.1	
3087376	Johnson Matthey Public Limited Company	18/12/2014	3087376	14821250.9	
3087705	Cisco Technology, Inc.	14/12/2014	3087705	14827610.8	
3087973	Dermopartners, S.L.	23/12/2013	3087973	13900130.9	
3088142	Kawasaki Jukogyo Kabushiki Kaisha	22/12/2014	3088142	14875707.3	
3088180	AGC Inc.	25/12/2014	3088180	14875400.5	
3088375	NGK SPARK PLUG CO., LTD.	27/12/2013	3088375	13879251.0	
3088428	Kuraray Co., Ltd.	24/12/2014	3088428	14873745.5	
3088429	Kuraray Co., Ltd.	24/12/2014	3088429	14874062.4	

3088520	B Food Science Co., Ltd. MicroBiopharm Japan Co., Ltd.	26/12/2014	3088520	14874041.8	
3088719	Aichi Machine Industry Co., Ltd.	19/08/2014	3088719	14875291.8	
3088732	General Electric Company	19/04/2016	3088732	16166071.7	
3088958	Kao Corporation	24/12/2014	3088958	14874532.6	
3089304	Hyosung Heavy Industries Corporation	24/12/2014	3089304	14873878.4	
3089486	Sony Corporation	22/09/2014	3089486	14873197.9	
3089601	Philip Morris Products S.A.	29/12/2014	3089601	14827236.2	
3089844	Alpha Assembly Solutions Inc.	31/12/2014	3089844	14877119.9	
3089886	Electric Road Ltd.	31/12/2014	3089886	14835679.3	
3089909	10546542 CANADA INC.	09/12/2014	3089909	14870062.8	
3090073	The Chemours Company FC, LLC	22/12/2014	3090073	14824327.2	
3090243	Howden Solyvent-Ventec	30/12/2014	3090243	14831043.6	French
3090586	Cisco Technology, Inc.	30/12/2014	3090586	14833619.1	
3090595	Cisco Technology, Inc.	30/12/2014	3090595	14828426.8	
3092061	Dow Global Technologies LLC	15/12/2014	3092061	14821448.9	
3092140	Raval A.C.S. LTD	08/12/2014	3092140	14825189.5	
3092404	Weptos A/S	04/12/2014	3092404	14806326.6	
3093145	Hewlett-Packard Development Company, L.P.	15/06/2011	3093145	16165113.8	
3093163	Sumitomo Rubber Industries, Ltd.	01/12/2014	3093163	14880068.3	
3094908	Quick Fitting, Inc.	29/12/2014	3094908	14876399.8	
3096032	NTN Corporation	11/12/2014	3096032	14877933.3	
3096215	Yulong Computer Telecommunication Scientific (Shenzhen) Co. Ltd.	15/01/2014	3096215	14879181.7	
3096321	Sony Corporation	01/12/2014	3096321	14878941.5	
3096472	Deutsche Telekom AG	20/05/2016	3096472	16170669.2	German
3096524	Saturn Licensing LLC	01/12/2014	3096524	14878449.9	
3096526	Saturn Licensing LLC	01/12/2014	3096526	14879006.6	
3096552	Sharp Kabushiki Kaisha	25/12/2014	3096552	14878851.6	
3096852	Sulzer Management AG	10/12/2014	3096852	14816176.3	
3098511	Oilon Technology Oy	14/04/2016	3098511	16165426.4	
3098712	Wuhan University Huawei Technologies Co., Ltd.	11/03/2015	3098712	15769226.0	
3099407	Fresenius HemoCare Italia Srl	17/12/2014	3099407	14814848.9	
3102232	Verastem, Inc.	06/02/2015	3102232	15746033.8	
3102779	Baker Hughes, a GE company, LLC	29/12/2014	3102779	14881620.0	

3104523	MediaTek Inc.	22/10/2015	3104523	15191028.8	
3105033	Global Filtration Systems, A DBA of Gulf Filtration Systems Inc.	06/02/2015	3105033	15745812.6	
3106024	Deere & Company	30/05/2016	3106024	16171869.7	German
3106485	Hitachi Chemical Co., Ltd.	12/02/2015	3106485	15749670.4	
3106504	Reliance Industries Limited	15/06/2016	3106504	16174614.4	
3107223	LG Electronics Inc.	17/12/2014	3107223	14882095.4	
3107637	Siemens Aktiengesellschaft	24/03/2015	3107637	15741799.9	German
3108117	United Technologies Corporation	16/02/2015	3108117	15793112.2	
3108144	Danfoss A/S	20/02/2014	3108144	14882987.2	
3113337	Breuckmann GmbH & Co. KG	14/06/2016	3113337	16174295.2	German
3115239	Nishikawa Rubber Co., Ltd. Toyota Jidosha Kabushiki Kaisha	09/06/2016	3115239	16173637.6	
3115744	TE Connectivity Germany GmbH TE Connectivity Corporation	09/07/2015	3115744	15176161.6	
3116279	Huawei Technologies Co., Ltd.	20/03/2015	3116279	15769069.4	
3116559	Hollister Incorporated	03/03/2015	3116559	15719875.5	
3116674	Illinois Tool Works Inc.	15/12/2014	3116674	14825022.8	
3117531	LG Electronics Inc.	15/12/2014	3117531	14885584.4	
3118244	Cnpharm Co., Ltd.	13/03/2015	3118244	15760898.5	
3118978	NITTOKU Co., Ltd.	28/04/2015	3118978	15796812.4	
3119854	Merck Patent GmbH	12/03/2015	3119854	15710433.2	German
3119964	Svein Berg Holding AS	27/02/2015	3119964	15714024.5	
3120103	American Technical Coatings, Inc.	18/03/2015	3120103	15795701.0	
3120951	ROBERT BOSCH GMBH	03/06/2016	3120951	16172823.3	German
3121891	Sekisui Chemical Co., Ltd.	19/03/2015	3121891	15764437.8	
3122103	Sharp Kabushiki Kaisha	20/03/2015	3122103	15764086.3	
3122947	Justoy Pty Ltd	27/02/2015	3122947	15767813.7	
3123731	Qualcomm Incorporated	24/03/2015	3123731	15719323.6	
3125860	Beiersdorf AG	20/03/2015	3125860	15710811.9	German
3126803	Kistler Holding AG	01/04/2015	3126803	15716709.9	German
3130264	Sunbeam Products, Inc.	22/07/2016	3130264	16001616.8	
3133701	Hamilton Sundstrand Corporation	18/08/2016	3133701	16184699.3	
3134450	PPG Industries Ohio, Inc.	27/04/2015	3134450	15722330.6	
3134606	Schlumberger Technology B.V.	24/04/2014	3134606	14889953.7	
3136045	Mitutoyo Corporation	12/08/2016	3136045	16183992.3	
3136643	Huawei Technologies Co., Ltd.	30/08/2016	3136643	16186401.2	

3136750	Logitech Europe S.A.	26/08/2016	3136750	16186049.9	
3137515	Basell Polyolefine GmbH	28/04/2015	3137515	15718498.7	
3137680	Stora Enso Oyj	29/04/2015	3137680	15785444.9	
3138104	CNIM Groupe	22/04/2015	3138104	15726230.4	French
3140449	Electrolux Appliances Aktiebolag	07/05/2014	3140449	14722659.1	
3140964	Telefonaktiebolaget LM Ericsson (publ)	02/04/2015	3140964	15721325.7	
3141207	Aesculap AG	02/08/2013	3141207	16195577.8	German
3141898	Stichting IMEC Nederland	12/09/2016	3141898	16188313.7	
3143811	Telefonaktiebolaget LM Ericsson (publ)	08/05/2015	3143811	15727886.2	
3143917	LG Electronics Inc.	13/12/2012	3143917	16192570.6	
3144080	Nippon Steel Corporation	12/05/2015	3144080	15792491.1	
3144510	Hyundai Motor Company	02/12/2015	3144510	15197480.5	
3145213	Huawei Technologies Co. Ltd.	29/05/2015	3145213	15809395.5	
3145828	Bemis Company, Inc.	19/05/2014	3145828	14892703.1	
3147012	Shenzhen Oct Vision Inc.	06/03/2015	3147012	15880788.3	
3149249	Metalogenia Research & Technologies S.L.	28/05/2015	3149249	15725019.2	
3150447	Alpha Corporation	26/05/2015	3150447	15799103.5	
3153620	LG Electronics Inc.	08/12/2014	3153620	14894332.7	
3153911	Menicon Co., Ltd.	29/05/2015	3153911	15803750.7	
3154239	Huawei Technologies Co., Ltd.	09/09/2015	3154239	15839187.0	
3154280	CASIO COMPUTER CO., LTD.	31/08/2016	3154280	16186464.0	
3156713	SHENZHEN TCL NEW TECHNOLOGY CO., LTD	11/12/2014	3156713	14894389.7	
3157956	Regeneron Pharmaceuticals, Inc.	19/06/2015	3157956	15738177.3	
3160121	Riso Kagaku Corporation	19/10/2016	3160121	16194555.5	
3161318	Ateliers Busch S.A.	27/06/2014	3161318	14738765.8	French
3162484	Black & Decker, Inc.	01/11/2016	3162484	16196736.9	
3163498	Xiaomi Inc.	24/03/2016	3163498	16162165.1	
3163972	Huawei Technologies Co. Ltd.	04/08/2014	3163972	14899294.4	
3165088	AGCO International GmbH	21/10/2016	3165088	16195058.9	
3165923	NIPPON STEEL Chemical & Material Co., Ltd.	30/06/2015	3165923	15814054.1	
3166807	Jaguar Land Rover Limited	07/07/2015	3166807	15734394.8	
3167235	Bluefors Cryogenics OY Ltd.	08/07/2015	3167235	15745408.3	
3167691	Pisani, Patrizio Pisani, Lucia	25/06/2015	3167691	15742090.2	

3168169	Mondi AG Werner & Mertz GmbH	13/11/2015	3168169	15194573.0	German
3168925	NGK Insulators, Ltd.	08/04/2015	3168925	15818827.6	
3170674	Toppan Printing Co., Ltd.	15/07/2015	3170674	15821965.9	
3170693	TOYOTA JIDOSHA KABUSHIKI KAISHA	18/11/2016	3170693	16199434.8	
3171433	Sumitomo Metal Mining Co., Ltd.	09/07/2015	3171433	15822794.2	
3171557	SAP SE	15/09/2016	3171557	16002008.7	
3172911	Bonge, Jr., Nicholas, Jay	20/07/2015	3172911	15824984.7	
3175964	Li, Caiyou	02/12/2016	3175964	16002573.0	
3176233	Pallmann GmbH	02/12/2016	3176233	16201874.1	German
3176678	Huawei Technologies Co., Ltd.	05/10/2016	3176678	16192311.5	
3177023	SK PLANET CO., LTD.	06/07/2015	3177023	15826754.2	
3177480	Jaguar Land Rover Limited	21/07/2015	3177480	15738934.7	
3178855	LG Chem, Ltd.	10/12/2015	3178855	15867386.3	
3179043	General Electric Company	07/12/2016	3179043	16202587.8	
3179047	United Technologies Corporation	12/12/2016	3179047	16203529.9	
3179061	Aktiebolaget SKF	10/12/2015	3179061	15306967.9	
3179686	ZTE Corporation	16/10/2014	3179686	14895064.5	
3179695	Telia Company AB	07/12/2016	3179695	16202591.0	
3180362	Calypso Biotech SA Merck Patent GmbH	13/08/2015	3180362	15749818.9	
3180989	Albert Handtmann Maschinenfabrik GmbH & Co. KG	16/12/2015	3180989	15200441.2	German
3181352	NIPPON STEEL NISSHIN CO., LTD.	16/12/2014	3181352	14899841.2	
3181655	SUEZ Groupe	18/12/2015	3181655	15201371.0	
3181817	United Technologies Corporation	07/12/2016	3181817	16202732.0	
3181820	United Technologies Corporation	07/12/2016	3181820	16202771.8	
3181836	Aktiebolaget SKF	17/12/2015	3181836	15307043.8	
3181905	Xylem Europe GmbH	16/12/2015	3181905	15200452.9	
3182115	Schneider Electric IT Corporation	06/12/2016	3182115	16202529.0	
3183892	Dirac Research AB	21/08/2014	3183892	14900064.8	
3184069	Medicaroid Corporation	02/12/2016	3184069	16201987.1	
3184191	Komax Holding AG	21/12/2015	3184191	15201628.3	German
3184197	General Electric Company	16/12/2016	3184197	16204607.2	
3184374	Autoliv Development AB	24/07/2015	3184374	15833567.9	
3184742	General Electric Company	13/12/2016	3184742	16203705.5	

3184778	C.R.F. Società Consortile per Azioni	24/12/2015	3184778	15202660.5	
3184813	Kite Gen Research S.R.L.	15/12/2016	3184813	16002663.9	
3184922	Rf-Technologies nv	16/12/2016	3184922	16204665.0	
3185241	Harman Becker Automotive Systems GmbH	23/12/2015	3185241	15202357.8	
3185335	The Swatch Group Research and Development Ltd.	21/12/2015	3185335	15201690.3	French
3185369	Oupiin Electronic (Kunshan) Co., Ltd	14/12/2016	3185369	16204113.1	
3185480	Xiaomi Inc.	12/12/2016	3185480	16203461.5	
3187207	AViTA Corporation	28/12/2016	3187207	16207031.2	
3187284	United Technologies Corporation	22/12/2016	3187284	16206426.5	
3187303	Illinois Tool Works, Inc.	23/11/2016	3187303	16200146.5	
3187433	Bemis Company, Inc.	29/12/2016	3187433	16207423.1	
3187756	Eagle Industry Co., Ltd.	14/07/2015	3187756	15836001.6	
3188030	Xilinx, Inc.	22/12/2016	3188030	16206191.5	
3188409	Juniper Networks, Inc.	15/12/2016	3188409	16204544.7	
3188422	Juniper Networks, Inc.	15/12/2016	3188422	16204290.7	
3188436	Deutsche Telekom AG	21/12/2016	3188436	16002715.7	
3189050	Griffith University	07/09/2015	3189050	15837720.0	
3189655	Aira Tech Corporation	14/09/2015	3189655	15839002.1	
3189862	Abiomed, Inc.	01/12/2011	3189862	17151268.4	
3190447	Ricoh Company, Ltd.	22/12/2016	3190447	16206436.4	
3191664	Metiba Verwaltungs GmbH	25/08/2015	3191664	15774498.8	German
3193482	Huawei Technologies Co., Ltd.	20/04/2015	3193482	15848459.2	
3195855	Shin-Etsu Chemical Co., Ltd.	29/06/2015	3195855	15837437.1	
3196315	ORITEST spol. s r.o. Veterinární a farmaceutická univerzita Brno	19/01/2016	3196315	16466002.9	
3196344	De Poortere Deco SA	20/12/2016	3196344	16205546.1	French
3196630	China National Tobacco Quality Supervision & Test Center	13/04/2015	3196630	15842509.0	
3196869	SHENZHEN TCL NEW TECHNOLOGY CO., LTD	13/12/2014	3196869	14902239.4	
3197170	Huawei Technologies Co. Ltd.	10/12/2015	3197170	15875067.9	
3198083	Elmer, Karl-Heinz	14/09/2015	3198083	15777604.8	German
3198589	Intel Corporation	28/08/2015	3198589	15843816.8	
3199203	Concert Pharmaceuticals Inc.	27/02/2009	3199203	17160882.1	

3199658	Tempel Steel Company	01/12/2016	3199658	16201711.5	
3199678	De Poortere Deco SA	20/12/2016	3199678	16205533.9	French
3200073	Huawei Technologies Co., Ltd.	03/12/2015	3200073	15905648.0	
3201044	Volkswagen Aktiengesellschaft	30/09/2015	3201044	15771125.0	German
3202690	Caljan Rite-Hite ApS	08/12/2016	3202690	16002622.5	
3202944	Tocalo Co., Ltd. Nippon Steel Corporation	02/10/2015	3202944	15847128.4	
3203560	LG Chem, Ltd.	09/12/2015	3203560	15871306.5	
3204210	Cryovac, LLC	08/10/2015	3204210	15778647.6	
3204263	Gentex Corporation	05/10/2015	3204263	15848866.8	
3204659	Vitesco Technologies Germany GmbH	14/09/2015	3204659	15766102.6	German
3206353	Technische Universität München	09/02/2016	3206353	16154802.9	
3207165	Mara Renewables Corporation	12/10/2015	3207165	15850374.8	
3208285	Japan Polyethylene Corporation Japan Polypropylene Corporation	15/10/2015	3208285	15849977.2	
3208998	Huawei Technologies Co., Ltd.	02/06/2015	3208998	15859758.3	
3209185	LG Electronics Inc.	16/09/2015	3209185	15851924.9	
3210847	Siemens Mobility AG	23/02/2016	3210847	16156826.6	German
3211321	General Electric Company	22/12/2016	3211321	16206147.7	
3211808	LG Electronics Inc.	24/12/2008	3211808	17165481.7	
3212070	Vitalsines International Inc.	27/10/2015	3212070	15854927.9	
3212840	Valmet AB	28/10/2015	3212840	15856135.7	
3212881	SAIPEM S.A.	29/10/2015	3212881	15798521.9	French
3213734	Bach, Harald	14/02/2017	3213734	17155985.9	German
3214332	NSK Ltd.	11/09/2015	3214332	15839574.9	
3214394	Whirlpool Corporation	01/03/2016	3214394	16158148.3	
3214798	Alibaba Group Holding Limited	22/10/2015	3214798	15854858.6	
3214823	Huawei Technologies Co., Ltd.	24/03/2015	3214823	15862787.7	
3214840	Panasonic Intellectual Property Management Co., Ltd.	27/11/2015	3214840	15866173.6	
3214954	Koninklijke Philips N.V.	27/10/2015	3214954	15786944.7	
3216485	LUC & BEL S.r.l.	08/03/2017	3216485	17000376.8	
3216908	LG Electronics Inc.	08/06/2015	3216908	15857531.6	
3217681	Fuji Xerox Co., Ltd.	01/09/2016	3217681	16186782.5	
3218694	In-Situ, Inc.	10/11/2015	3218694	15859681.7	
3219203	Unicharm Corporation	12/12/2014	3219203	14906090.7	
3219600	The Boeing Company	20/12/2016	3219600	16205228.6	

3220269	Huawei Technologies Co. Ltd.	02/09/2015	3220269	15866644.6
3220688	HUAWEI TECHNOLOGIES CO., LTD.	09/03/2017	3220688	17160195.8
3221371	Monolythix, Inc. Alfred E. Mann Foundation for Scientific Research	20/11/2014	3221371	14821907.4
3221661	Canon Kabushiki Kaisha	13/11/2015	3221661	15860826.5
3222138	Unicharm Corporation	13/11/2015	3222138	15860673.1
3222422	OCE Holding B.V.	21/03/2017	3222422	17162036.2
3223048	HUAWEI TECHNOLOGIES CO., LTD.	11/12/2014	3223048	14907637.4
3223620	Hill's Pet Nutrition, Inc.	27/12/2014	3223620	14830774.7
3223659	Colgate-Palmolive Company	23/12/2014	3223659	14824745.5
3224313	SABIC Global Technologies B.V.	24/11/2015	3224313	15816933.4
3224997	Ricoh Company, Limited	09/11/2015	3224997	15862681.2
3225008	Microsoft Technology Licensing, LLC	16/11/2015	3225008	15801605.5
3225637	LG Chem, Ltd.	24/12/2015	3225637	15892698.0
3225791	Doosan Heavy Industries & Construction Co., Ltd.	05/12/2016	3225791	16202247.9
3226436	Huawei Technologies Co., Ltd.	17/12/2014	3226436	14908169.7
3226507	Huawei Technologies Co., Ltd.	01/09/2015	3226507	15869079.2
3226597	HUAWEI TECHNOLOGIES CO., LTD.	22/12/2014	3226597	14908682.9
3226712	Nite Ize, Inc.	02/12/2015	3226712	15865178.6
3226963	Med-El Elektromedizinische Geraete GmbH	02/12/2015	3226963	15864762.8
3227218	Otis Elevator Company	02/12/2015	3227218	15816979.7
3227277	Pulmocide Limited	04/12/2015	3227277	15808770.0
3227278	Pulmocide Limited	04/12/2015	3227278	15817507.5
3227514	Cesium AB	04/12/2015	3227514	15866197.5
3227515	V-Glass LLC	02/12/2015	3227515	15865872.4
3227563	Breakthrough Technologies, LLC	04/12/2015	3227563	15866328.6
3227633	Smithe, Robert Olszak, Artur Szwaykowski, Piotr APRE Instruments, Inc.	03/12/2015	3227633	15865419.4
3227864	Inventio AG	02/12/2015	3227864	15801882.0

3227926	Tesla, Inc.	04/12/2015	3227926	15823849.3	
3228014	Murata Manufacturing Co., Ltd.	04/12/2015	3228014	15866230.4	
3228041	Marvell World Trade, Ltd.	07/12/2015	3228041	15816629.8	
3228113	Telefonaktiebolaget LM Ericsson (publ)	18/12/2014	3228113	14828575.2	
3228131	Telefonaktiebolaget LM Ericsson (publ)	01/12/2014	3228131	14907421.3	
3228274	STEGER, Heinrich	30/03/2017	3228274	17163921.4	German
3228547	Ball Beverage Can South America S.A.	03/12/2015	3228547	15828662.5	
3228672	Tokuyama Corporation	02/12/2015	3228672	15865188.5	
3228978	Unity Semiconductor	21/06/2016	3228978	16175444.5	
3229323	Ormazabal Y Cia S.L.U.	01/12/2014	3229323	14907365.2	
3229740	Think Surgical, Inc.	11/12/2015	3229740	15867152.9	
3229816	Tricida Inc.	10/12/2015	3229816	15823049.0	
3230121	Bombardier Inc.	04/12/2015	3230121	15808825.2	
3230404	cynora GmbH	08/12/2015	3230404	15825601.6	German
3230408	BP P.L.C.	02/12/2015	3230408	15804756.3	
3230418	Leibniz-Institut für Polymerforschung Dresden e.V.	09/12/2015	3230418	15820451.1	German
3230476	Mayo Foundation for Medical Education and Research Exact Sciences Development Company, LLC	11/12/2015	3230476	15868140.3	
3230550	Baker Hughes, a GE company, LLC	09/12/2015	3230550	15868506.5	
3230632	Semba Biosciences, Inc.	01/12/2015	3230632	15870643.2	
3230637	Parker-Hannifin Corporation	10/12/2015	3230637	15817037.3	
3230695	Daniel Measurement and Control, Inc.	09/12/2015	3230695	15866780.8	
3230696	Endress+Hauser Flowtec AG	03/11/2015	3230696	15794854.8	German
3230972	Amazon Technologies, Inc.	11/12/2015	3230972	15823242.1	
3231001	Commissariat à l'énergie atomique et aux énergies alternatives Forschungszentrum Jülich GmbH	11/12/2014	3231001	14818927.7	
3231058	Fisher Controls International LLC	11/12/2015	3231058	15819978.6	
3231066	Audi AG Karlsruher Institut für Technologie	26/11/2015	3231066	15801990.1	German
3231232	Gemalto M2M GmbH	26/11/2015	3231232	15802053.7	
3231235	Telefonaktiebolaget LM Ericsson (publ)	14/12/2015	3231235	15816889.8	
3231238	Telecom Italia S.p.A.	10/12/2014	3231238	14821529.6	
3231437	Nihon Sizen Hakkoh Co., Ltd.	01/12/2015	3231437	15868543.8	

3231558	3M Innovative Properties Company	11/04/2016	3231558	16164700.3	
3232095	MAHLE Filter Systems Japan Corporation	12/04/2017	3232095	17166139.0	
3232329	CANON KABUSHIKI KAISHA	23/03/2017	3232329	17000483.2	
3232592	Huawei Technologies Co. Ltd.	11/12/2014	3232592	14907632.5	
3232594	LG Electronics Inc.	07/12/2015	3232594	15867642.9	
3232607	Huawei Technologies Co., Ltd.	28/12/2015	3232607	15875189.1	
3232768	AGCO Corporation	14/12/2015	3232768	15817729.5	
3232790	Heliae Development LLC	16/12/2015	3232790	15871011.1	
3232828	Philip Morris Products S.A.	16/12/2015	3232828	15813357.9	
3232978	Norwegian University of Science and Technology (NTNU)	16/12/2015	3232978	15817793.1	
3233060	Société d'Exploitation de Produits pour les Industries Chimiques SEPPIC	07/12/2015	3233060	15817481.3	French
3233210	Sederma	14/12/2015	3233210	15817569.5	
3233216	Minimax GmbH & Co. KG	18/12/2015	3233216	15813444.5	German
3233240	Hollingsworth & Vose Company	18/12/2015	3233240	15871184.6	
3233302	Orkla House Care AB	17/12/2015	3233302	15870467.6	
3233332	Gebr. Krallmann GmbH	15/12/2015	3233332	15822909.6	German
3233333	Gebr. Krallmann GmbH	15/12/2015	3233333	15822910.4	German
3233443	Renault S.A.S.	10/12/2015	3233443	15817985.3	French
3233618	Velometro Mobility Inc.	14/12/2015	3233618	15868770.7	
3233945	PPG Industries Ohio, Inc.	14/12/2015	3233945	15825985.3	
3234244	PrimaLoft, Inc.	17/12/2015	3234244	15871047.5	
3234350	Vestas Wind Systems A/S	16/12/2015	3234350	15812877.7	
3234696	Flint Group Germany GmbH	16/12/2015	3234696	15816138.0	German
3235059	Saab AB	19/12/2014	3235059	14908531.8	
3235071	Zumtobel Lighting GmbH	17/12/2015	3235071	15817757.6	German
3235072	Zumtobel Lighting GmbH	15/12/2015	3235072	15820066.7	German
3235074	Gustav Klauke GmbH	14/12/2015	3235074	15813325.6	German
3235252	Telefonaktiebolaget LM Ericsson (publ)	17/12/2015	3235252	15828528.8	
3235748	Shanghai Hongyan Returnable Transit Packagings Co., Ltd.	15/12/2015	3235748	15869320.0	
3235826	Fu, Li	23/12/2014	3235826	14908284.4	
3235838	LG Chem, Ltd.	15/12/2015	3235838	15870288.6	
3236532	The Boeing Company	10/02/2017	3236532	17155543.6	
3236550	Komax Holding AG	21/04/2016	3236550	16166466.9	German

3236725	Rolls-Royce plc	21/03/2017	3236725	17162074.3	
3236782	Evonik Operations GmbH	17/12/2015	3236782	15810737.5	
3236783	Evonik Operations GmbH	17/12/2015	3236783	15820481.8	
3236809	RTC Industries, Inc.	22/12/2015	3236809	15821009.6	
3236879	3Shape A/S	21/12/2015	3236879	15813452.8	
3236882	Automed Pty Ltd	22/12/2015	3236882	15871354.5	
3236930	L'Oréal	10/12/2015	3236930	15807929.3	French
3236940	Ardelyx, Inc.	22/12/2015	3236940	15828619.5	
3237097	Dr. Schneider Automotive Polska Spółka Z Ograniczona Odpowiedzialnoscia	21/12/2015	3237097	15828398.6	
3237103	Haldor Topsøe A/S	18/12/2015	3237103	15819812.7	
3237242	Renault S.A.S.	17/12/2015	3237242	15830801.5	French
3237370	POSCO Research Institute of Industrial Science & Technology Nederlandse Organisatie voor toegepast- natuurwetenschappelijk onderzoek TNO	24/12/2015	3237370	15873683.5	
3237741	Safran Nacelles	22/12/2015	3237741	15823706.5	French
3237760	ABB Turbo Systems AG	22/12/2015	3237760	15823510.1	German
3237767	Lisi Aerospace	22/12/2014	3237767	14853176.7	
3237772	Compagnie Plastic Omnium	22/12/2015	3237772	15828358.0	French
3237849	Endress+Hauser Flowtec AG	10/12/2015	3237849	15807934.3	German
3238135	CALIFORNIA INSTITUTE OF TECHNOLOGY	22/12/2015	3238135	15874344.3	
3238354	ABB Schweiz AG	24/12/2015	3238354	15826190.9	
3238476	Intel Corporation	04/12/2015	3238476	15874091.0	
3238723	EA Pharma Co., Ltd.	21/12/2015	3238723	15873009.3	
3238907	Toyoda Iron Works Co., Ltd.	21/12/2015	3238907	15873025.9	
3239150	Takeda Pharmaceutical Company Limited	21/12/2015	3239150	15873002.8	
3239159	LG Chem, Ltd.	24/12/2015	3239159	15873697.5	
3239249	Kao Corporation	15/12/2015	3239249	15872829.5	
3239343	Posco	23/12/2015	3239343	15873642.1	
3239995	Eagle Industry Co., Ltd.	21/12/2015	3239995	15872960.8	
3240207	LG Electronics Inc.	23/12/2015	3240207	15873659.5	

3240214	LG Electronics Inc.	23/12/2015	3240214	15873652.0	
3240348	LG Electronics Inc.	23/12/2015	3240348	15873653.8	
3240404	IMERTECH SAS	23/12/2015	3240404	15817524.0	
3240695	Compagnie Générale des Etablissements Michelin	30/12/2015	3240695	15828809.2	
3240731	Philip Morris Products S.A.	15/12/2015	3240731	15823788.3	
3240739	Philip Morris Products S.A.	30/12/2015	3240739	15820870.2	
3240946	RENAULT s.a.s.	10/12/2015	3240946	15817986.1	French
3241028	Technoprobe S.p.A	14/12/2015	3241028	15823139.9	
3241128	Huawei Technologies Co. Ltd.	24/12/2015	3241128	15875169.3	
3241260	MACOM Technology Solutions Holdings, Inc.	02/12/2015	3241260	15875928.2	
3241277	Energous Corporation	22/12/2015	3241277	15876033.0	
3241307	Xieon Networks S.à r.l.	18/12/2015	3241307	15813832.1	
3241721	LG Innotek Co., Ltd.	22/12/2015	3241721	15875586.8	
3242367	Hyosung Heavy Industries Corporation	24/12/2015	3242367	15875622.1	
3243255	Eaton Corporation	17/12/2015	3243255	15820022.0	
3243337	Goertek Inc.	05/01/2015	3243337	15876435.7	
3243802	SWISON CREATIVE ENVIRONMENTAL SOLUTIONS CO., LTD.	30/12/2015	3243802	15876710.3	
3243876	Mitsubishi Engineering-Plastics Corporation	14/12/2015	3243876	15876990.1	
3244809	Paradox Medical	21/12/2015	3244809	15832799.9	
3245378	voestalpine Tubulars GmbH & Co KG	29/12/2015	3245378	15820024.6	German
3246964	LG Chem, Ltd.	08/09/2016	3246964	16853824.7	
3248171	Google LLC	14/12/2015	3248171	15828579.1	
3248193	Silicon Storage Technology Inc.	04/12/2015	3248193	15813222.5	
3249357	Murata Manufacturing Co., Ltd.	10/05/2017	3249357	17170316.8	
3249656	Ormazabal Corporate Technology, A.I.E.	20/01/2015	3249656	15708847.7	
3250849	GAZTRANSPORT ET TECHNIGAZ	14/01/2016	3250849	16703571.6	French
3251961	Yoshino Kogyosho Co., Ltd.	20/01/2016	3251961	16742949.7	
3252449	STMicroelectronics S.r.l.	23/12/2016	3252449	16206884.5	
3254658	Hill-Rom Services, Inc.	02/12/2010	3254658	17179619.6	
3255342	Robert Bosch GmbH	25/04/2017	3255342	17167855.0	German
3255454	Furuno Electric Co., Ltd.	15/12/2015	3255454	15881217.2	

3256750	Sew-Eurodrive GmbH & Co. KG	18/11/2015	3256750	15808101.8	German
3257219	Giesecke+Devrient Mobile Security GmbH	05/02/2016	3257219	16705729.8	German
3257341	Dell Products, L.P.	30/12/2015	3257341	15882277.5	
3258670	3G Licensing S.A.	02/04/2004	3258670	17175881.6	
3258754	King Slide Works Co., Ltd. King Slide Technology Co., Ltd.	28/12/2016	3258754	16207077.5	
3258820	Almblad, Robert	19/02/2016	3258820	16753143.3	
3259881	Huawei Technologies Co. Ltd.	24/03/2016	3259881	16767772.3	
3260859	Expression Pathology, Inc.	22/12/2010	3260859	17001320.5	
3263476	Owens-Brockway Glass Container Inc.	05/11/2013	3263476	17183307.2	
3263992	Electrolux Appliances Aktiebolag	27/06/2016	3263992	16176453.5	
3266863	PROSOL S.p.A.	30/06/2017	3266863	17178939.9	
3267593	China Academy of Telecommunications Technology	14/01/2016	3267593	16761005.4	
3267749	Nippon Telegraph and Telephone Corporation	04/03/2016	3267749	16761688.7	
3268309	WorleyParsons Europe Ltd.	17/12/2015	3268309	15821044.3	
3268413	Einar A/S	10/03/2016	3268413	16709391.3	
3268543	Neoperl GmbH	21/01/2016	3268543	16702024.7	German
3268751	Technoprobe S.p.A	10/03/2016	3268751	16713743.9	
3269121	Telefonaktiebolaget LM Ericsson (PUBL)	12/03/2015	3269121	15711689.8	
3269146	QUALCOMM INCORPORATED	11/03/2016	3269146	16713200.0	
3269440	Filtration Group GmbH	20/06/2017	3269440	17176911.0	German
3270047	Trilux GmbH & Co. KG	13/03/2017	3270047	17160595.9	German
3270460	LG Innotek Co., Ltd.	07/12/2015	3270460	15884783.0	
3271209	Adient Luxembourg Holding S.à r.l.	16/03/2016	3271209	16710181.5	German
3271261	Ecolab USA Inc.	17/03/2016	3271261	16765748.5	
3271412	Covestro Deutschland AG	14/03/2016	3271412	16709799.7	German
3272571	Phihong Technology Co., Ltd.	03/01/2017	3272571	17150166.1	
3272810	Unitika Ltd.	14/03/2016	3272810	16764939.1	
3272820	NOK Corporation	10/02/2016	3272820	16752368.7	
3273118	NOK Corporation	26/02/2016	3273118	16764665.2	
3275423	BTL Cosmetics	27/07/2017	3275423	17183477.3	French
3275823	KONE Corporation	18/12/2013	3275823	17187981.0	
3275870	Gilead Sciences, Inc.	08/05/2012	3275870	17187226.0	

3276635	REV Ritter GmbH	22/12/2016	3276635	16206177.4	German
3276915	Huawei Technologies Co. Ltd.	21/05/2015	3276915	15892214.6	
3277048	HUAWEI TECHNOLOGIES CO., LTD.	10/04/2015	3277048	15888214.2	
3277634	Granitifiandre S.p.A.	01/04/2016	3277634	16725574.4	
3278873	Nippon Shokubai Co., Ltd.	29/03/2016	3278873	16772857.5	
3279113	Reco Co., Ltd.	17/12/2015	3279113	15887894.2	
3279257	Hyundai Motor Company Kia Motors Corporation	15/12/2016	3279257	16204314.5	
3280612	Adient Luxembourg Holding S.à r.l.	01/04/2016	3280612	16712935.2	German
3280614	Adient Luxembourg Holding S.à r.l.	01/04/2016	3280614	16713452.7	German
3282230	Hexagon Technology Center GmbH	04/12/2014	3282230	16202380.8	German
3282505	Samsung Electronics Co., Ltd.	12/07/2017	3282505	17180983.3	
3283042	BSN Medical GmbH	15/04/2016	3283042	16719329.1	
3283421	Giesecke+Devrient Currency Technology GmbH	15/04/2016	3283421	16717837.5	German
3286047	Washme Properties, LLC	22/04/2016	3286047	16719707.8	
3286603	Institut National De La Recherche Scientifique	12/04/2016	3286603	16782417.6	
3287737	Datalogic USA, Inc.	22/08/2017	3287737	17187195.7	
3287841	Samsung Electronics Co., Ltd.	16/08/2017	3287841	17186489.5	
3288153	Sagemcom Energy & Telecom SAS	22/08/2017	3288153	17187286.4	French
3288231	Huawei Technologies Co., Ltd.	30/09/2016	3288231	16877427.1	
3289036	Avery Dennison Corporation	29/04/2016	3289036	16730929.3	
3289216	Intex Holdings Pty Ltd.	28/04/2016	3289216	16785682.2	
3289445	Huawei Technologies Co. Ltd.	15/02/2016	3289445	16802335.6	
3290232	The Goodyear Tire & Rubber Company	29/08/2017	3290232	17188429.9	
3290988	Shenzhen Royole Technologies Co., Ltd.	30/04/2015	3290988	15890367.4	
3291746	Creative Balloons GmbH	09/05/2016	3291746	16731313.9	German
3292150	Cytomx Therapeutics Inc.	04/05/2016	3292150	16722502.8	
3293588	Siemens Schweiz AG	08/09/2016	3293588	16187810.3	German
3293990	Toshiba Tec Kabushiki Kaisha	11/09/2017	3293990	17190449.3	
3294387	Hahn-Schickard-Gesellschaft für angewandte Forschung e.V.	12/05/2016	3294387	16722653.9	German
3294967	Sailshadow S.r.l.	10/05/2016	3294967	16731329.5	
3295060	SEW-EURODRIVE GmbH & Co. KG	19/04/2016	3295060	16717100.8	German

3295583	INTEL Corporation	23/12/2015	3295583	15891998.5	
3295652	Huawei Technologies Co., Ltd.	08/10/2016	3295652	16856818.6	
3295798	MANICA S.p.A.	08/09/2017	3295798	17001510.1	
3296702	Renishaw PLC	31/07/2014	3296702	17195518.0	
3297092	Huawei Technologies Co., Ltd.	29/05/2015	3297092	15893651.8	
3297870	Gentex Corporation	17/05/2016	3297870	16797157.1	
3297992	Chong Kun Dang Pharmaceutical Corp.	20/05/2016	3297992	16800269.9	
3297999	Bayer CropScience Aktiengesellschaft	19/05/2016	3297999	16723371.7	
3298193	Voith Patent GmbH	04/05/2016	3298193	16721778.5	German
3298356	Deere & Company	18/05/2016	3298356	16797181.1	
3298777	MediaTek Singapore Pte. Ltd.	07/07/2016	3298777	16823825.1	
3299290	Bell Helicopter Textron Inc.	23/12/2016	3299290	16206787.0	
3300080	Sony Corporation	12/05/2016	3300080	16796091.3	
3301003	HONDA MOTOR CO., LTD.	29/09/2017	3301003	17194204.8	
3301120	LG Chem, Ltd.	16/12/2016	3301120	16876086.6	
3302063	Nano-Tech Polska SP. Z.O.O. SP. K.	25/05/2016	3302063	16738888.3	
3303293	Lead Pharma B.V.	03/06/2016	3303293	16726888.7	
	SANOFI				
3304614	Medartis Holding AG	20/05/2015	3304614	15723941.9	German
3304969	Samsung Electronics Co., Ltd.	30/05/2016	3304969	16803706.7	
3305794	Consejo Superior de Investigaciones Científicas (CSIC)	27/04/2016	3305794	16789355.1	
	The Governing Council of the University of Toronto				
3306134	Hitachi Construction Machinery Co., Ltd.	01/03/2016	3306134	16802862.9	
3306273	Hexagon Technology Center GmbH	04/12/2014	3306273	16202382.4	German
3306865	Tencent Technology (Shenzhen) Company Limited	14/04/2016	3306865	16799149.6	
3307550	Bundesdruckerei GmbH	09/06/2016	3307550	16727734.2	German
3307751	Ren Fuel K2B AB	15/06/2016	3307751	16732794.9	
3308055	Sew-Eurodrive GmbH & Co. KG	24/05/2016	3308055	16724592.7	German
3308483	Telefonaktiebolaget LM Ericsson (publ)	15/06/2015	3308483	15750110.7	
3308524	Intel Corporation	23/05/2016	3308524	16808013.3	
3309628	ETA SA Manufacture Horlogère Suisse	11/10/2016	3309628	16193192.8	French
3310611	Adient Luxembourg Holding S.à r.l.	15/06/2016	3310611	16729893.4	German
3311006	Nuovo Pignone Tecnologia - S.r.l.	06/05/2016	3311006	16722849.3	

3311015	AVL List GmbH	20/06/2016	3311015	16732261.9	German
3311112	Robert Bosch GmbH	07/06/2016	3311112	16727486.9	German
3313161	FUJI Corporation	18/06/2015	3313161	15895648.2	
3313997	Danmarks Tekniske Universitet	24/06/2016	3313997	16734236.9	
3314997	Deere & Company	24/10/2017	3314997	17197981.8	
3316265	Sumida Corporation	13/10/2017	3316265	17196365.5	
3316659	Huawei Technologies Co., Ltd.	23/05/2016	3316659	16845541.8	
3317109	Ingenico Group	30/06/2016	3317109	16739048.3	French
3318609	The Boeing Company	02/11/2017	3318609	17199738.0	
3318817	Chiyoda Corporation	02/07/2015	3318817	15897188.7	
3318818	Chiyoda Corporation	02/07/2015	3318818	15897190.3	
3319602	Advenchen Pharmaceuticals LLC	10/07/2016	3319602	16824974.6	
3319952	Noramco, Inc.	01/07/2016	3319952	16741447.3	
3320238	W.L. Gore & Associates GmbH	04/07/2016	3320238	16734652.7	German
3320256	GAZTRANSPORT ET TECHNIGAZ	05/07/2016	3320256	16744807.5	French
3320401	Carl Zeiss SMT GmbH	07/07/2016	3320401	16736851.3	German
3320425	Telefonaktiebolaget LM Ericsson (PUBL)	06/07/2016	3320425	16734724.4	
3321056	Mitsubishi Heavy Industries, Ltd. Toray Industries, Inc.	02/12/2016	3321056	16853192.9	
3321102	Sumitomo Rubber Industries, Ltd.	26/10/2017	3321102	17198429.7	
3321388	JFE Steel Corporation	06/07/2016	3321388	16821424.5	
3321568	Contemporary Visions, LLC	08/11/2017	3321568	17200541.5	
3322076	Siemens Aktiengesellschaft	14/11/2016	3322076	16198690.6	German
3322079	Niko NV	09/11/2017	3322079	17200937.5	
3322119	HUAWEI TECHNOLOGIES CO., LTD.	13/11/2017	3322119	17201337.7	
3322230	Huawei Technologies Co., Ltd.	17/08/2015	3322230	15901370.5	
3322289	Izinovation Sillion, Bernard Verd, Jean Michel Bergue, Bertrand	12/07/2016	3322289	16741583.5	French
3322469	Cook Regentec LLC	13/07/2016	3322469	16744619.4	
3322851	Varo Teollisuuspalvelut OY	05/11/2015	3322851	15898187.8	
3322885	Siemens Aktiengesellschaft	08/08/2016	3322885	16751276.3	
3322916	SEW-EURODRIVE GmbH & Co. KG	15/06/2016	3322916	16730688.5	German
3324102	Tam, Chi Ming	14/11/2017	3324102	17201512.5	

3324657	Nokia Solutions and Networks Oy	30/11/2000	3324657	18150458.0	
3324798	SEB S.A.	19/07/2016	3324798	16757690.9	French
3325122	BASF SE	05/07/2016	3325122	16736068.4	German
3325808	Edwards Limited	15/06/2016	3325808	16731259.4	
3326360	Samsung Electronics Co., Ltd.	29/04/2016	3326360	16827919.8	
3326852	AUDI AG	19/10/2017	3326852	17197204.5	German
3326913	Airbus Defence and Space, S.A.U.	24/11/2016	3326913	16382553.2	
3328259	Illinois Tool Works Inc.	20/07/2016	3328259	16745327.3	
3328289	HIP Innovation Technology, LLC	15/07/2016	3328289	16831033.2	
3328714	Valeo Schalter und Sensoren GmbH	20/07/2016	3328714	16751193.0	German
3329199	Siti - B&T Group S.p.A.	30/07/2015	3329199	15772008.7	
3329633	Celeno Communications (Israel) Ltd.	27/07/2016	3329633	16832389.7	
3329787	Famenity Co., Ltd.	19/10/2015	3329787	15906744.6	
3329903	Beiersdorf AG	21/11/2017	3329903	17202748.4	German
3330547	Goodrich Corporation	04/12/2017	3330547	17205269.8	
3330583	Eaton Corporation	13/12/2013	3330583	17204760.7	
3331089	Airbus Defence and Space GmbH	01/12/2017	3331089	17204899.3	German
3331414	LG Electronics Inc.	18/07/2016	3331414	16833210.4	
3332026	F. Hoffmann-La Roche AG	04/08/2016	3332026	16750429.9	
3332463	Sew-Eurodrive GmbH & Co. KG	13/07/2016	3332463	16744307.6	German
3332851	Wakeparx GmbH	06/12/2017	3332851	17205711.9	German
3332931	Duerdoth, Tobias	06/12/2017	3332931	17205773.9	German
3332983	Capital One Services, LLC	04/12/2017	3332983	17205265.6	
3333072	AIRBUS HELICOPTERS DEUTSCHLAND GmbH	07/12/2016	3333072	16400059.8	
3333094	Redbox S.R.L.	07/12/2017	3333094	17206006.3	
3333116	Jungheinrich Aktiengesellschaft	04/12/2017	3333116	17205166.6	German
3333238	The Boeing Company	26/10/2017	3333238	17198670.6	
3333265	Oregon Health & Science University	16/05/2011	3333265	17197412.4	
3333294	Goodrich Corporation	07/12/2017	3333294	17205985.9	
3333448	B Lam Limited	08/12/2017	3333448	17206156.6	
3333643	The Swatch Group Research and Development Ltd	06/12/2016	3333643	16202428.5	French
3333662	Industrial Technology Research Institute	29/12/2016	3333662	16207253.2	
3333975	Sumida Corporation	07/12/2017	3333975	17205825.7	
3334058	Huawei Technologies Co., Ltd.	02/09/2015	3334058	15902615.2	

3334124	Huawei Technologies Co., Ltd.	26/05/2011	3334124	17193096.9	
3334806	ExxonMobil Research and Engineering Company	12/08/2016	3334806	16754626.6	
3335621	Tomey Corporation	15/12/2017	3335621	17207599.6	
3335695	UPM-Kymmene Corporation	15/12/2016	3335695	16397537.8	
3336014	Woosh Washrooms	14/12/2017	3336014	17207462.7	
3336179	Industrial Technology Research Institute	12/12/2017	3336179	17206585.6	
3336269	SCHÖCK BAUTEILE GmbH	12/12/2017	3336269	17206599.7	German
3336382	Allison Transmission, Inc.	15/12/2017	3336382	17207828.9	
3336420	H4X e.U.	14/12/2017	3336420	17207328.0	German
3336429	Delavan, Inc.	13/12/2017	3336429	17206973.4	
3336437	Peaceworld Co., Ltd. Aircook Co., Ltd	24/06/2016	3336437	16835288.8	
3336479	Safariland, LLC	06/12/2017	3336479	17205735.8	
3336937	StoreDot Ltd.	12/12/2017	3336937	17206661.5	
3336958	LG Chem, Ltd.	02/12/2016	3336958	16871068.9	
3336973	SMK Corporation	07/12/2015	3336973	15891025.7	
3337181	GN Audio A/S	15/12/2016	3337181	16204281.6	
3337205	Samsung Electronics Co., Ltd.	15/12/2017	3337205	17207737.2	
3337304	ABB Schweiz AG	19/12/2016	3337304	16205013.2	
3337368	Samsung Electronics Co., Ltd.	02/12/2016	3337368	16879213.3	
3337745	Otis Elevator Company	19/08/2015	3337745	15756874.2	
3338777	Allergan, Inc.	16/09/2011	3338777	18157147.2	
3338975	BIESSE S.p.A.	12/12/2017	3338975	17206803.3	
3339064	RUD Ketten Rieger & Dietz GmbH u. Co. KG	06/12/2017	3339064	17205662.4	German
3339110	Asahi Denso Co., Ltd.	19/12/2017	3339110	17208392.5	
3339111	Asahi Denso Co., Ltd.	19/12/2017	3339111	17208395.8	
3339162	The Boeing Company	21/12/2017	3339162	17209657.0	
3339201	Teuman S.A.S. di Nicolini Marco	22/12/2017	3339201	17210402.8	
3339258	Heraeus Quarzglas GmbH & Co. KG	04/12/2017	3339258	17205079.1	German
3339391	Evonik Operations GmbH	14/12/2017	3339391	17207219.1	
3339455	Montres Breguet S.A.	20/12/2016	3339455	16205419.1	French
3339614	Yamaha Hatsudoki Kabushiki Kaisha	20/12/2017	3339614	17208711.6	
3339668	Nuovo Pignone Tecnologie SrL	15/12/2017	3339668	17207647.3	

3339688	Kabushiki Kaisha Tokai Rika Denki Seisakusho	20/12/2017	3339688	17208905.4	
3339689	Kabushiki Kaisha Tokai Rika Denki Seisakusho	20/12/2017	3339689	17208907.0	
3339747	Vestel Elektronik Sanayi ve Ticaret A.S.	23/12/2016	3339747	16206860.5	
3339773	Vestel Elektronik Sanayi ve Ticaret A.S.	22/12/2016	3339773	16206196.4	
3340355	The Boeing Company	20/12/2016	3340355	16382626.6	
3340454	Melexis Bulgaria Ltd.	20/12/2016	3340454	16205471.2	
3340546	Vestel Elektronik Sanayi ve Ticaret A.S.	23/12/2016	3340546	16206690.6	
3340653	GN Hearing A/S	22/12/2016	3340653	16206073.5	
3342099	Siemens Aktiengesellschaft	08/12/2015	3342099	15813301.7	
3342103	Samsung Electronics Co., Ltd.	05/12/2016	3342103	16871104.2	
3342459	Neuboron Medtech Ltd.	18/07/2016	3342459	16850180.7	
3342483	LG Chem, Ltd.	17/03/2017	3342483	17770547.2	
3342650	Joyson Safety Systems Japan K.K.	27/12/2017	3342650	17210660.1	
3342740	KONE Corporation	29/12/2016	3342740	16207231.8	
3342845	JXTG Nippon Oil & Energy Corporation	22/12/2017	3342845	17210072.9	
3342948	Sapa AS	22/12/2017	3342948	17002071.3	German
3342987	Ansaldo Energia IP UK Limited	30/12/2016	3342987	16207567.5	
3343053	AI ALPINE US BIDCO INC.	07/12/2017	3343053	17205970.1	
3343123	Atlantic Climatisation et Ventilation	18/12/2017	3343123	17208070.7	French
3343138	Samsung Electronics Co., Ltd.	22/12/2017	3343138	17210027.3	
3343276	Samsung Electronics Co., Ltd.	22/12/2017	3343276	17210502.5	
3343386	GN Audio A/S	30/12/2016	3343386	16207602.0	
3343450	The Swatch Group Research and Development Ltd	29/12/2016	3343450	16207333.2	French
3343867	Lookingglass Cyber Solutions, Inc.	20/12/2017	3343867	17209170.4	
3343893	Riso Kagaku Corporation	08/07/2016	3343893	16832687.4	
3345780	MAGNA STEYR Fuel Systems GmbH Werk Schwäbisch Gmünd	05/12/2017	3345780	17205491.8	German
3346368	FUJIFILM Corporation	07/07/2016	3346368	16841280.7	
3346628	Huawei Technologies Co., Ltd.	25/09/2015	3346628	15904487.4	

3346729	Harman Becker Automotive Systems GmbH	22/12/2017	3346729	17209908.7	
3346775	Huawei Technologies Co., Ltd.	31/07/2012	3346775	17201451.6	
3346942	Sicat GmbH & CO. KG	06/09/2016	3346942	16760733.2	German
3347611	Jaguar Land Rover Limited	02/09/2016	3347611	16763740.4	
3347992	Huawei Technologies Co., Ltd.	01/12/2016	3347992	16872352.6	
3348324	Tersano Inc.	30/09/2010	3348324	17192448.3	
3348908	Rolls-Royce plc	11/12/2017	3348908	17206501.3	
3349197	Siemens Schweiz AG	13/12/2017	3349197	17207122.7	German
3349376	Hisilicon Optoelectronics Co., Ltd.	29/12/2017	3349376	17211038.9	
3349631	CWS-boco International GmbH	16/09/2015	3349631	15771499.9	German
3350354	Novelis, Inc.	06/12/2016	3350354	16819768.9	
3352961	Next Generation Recyclingmaschinen GmbH	21/09/2016	3352961	16767315.1	German
3353025	WABCO GmbH	22/07/2016	3353025	16747442.8	German
3353123	L'Air Liquide Société Anonyme pour l'Etude et l'Exploitation des Procédés Georges Claude	28/07/2016	3353123	16756729.6	French
3353163	Janssen Pharmaceutica, N.V.	23/09/2016	3353163	16770283.6	
3353917	Huawei Technologies Co., Ltd.	19/10/2015	3353917	15781924.4	
3354325	Völkl Sports GmbH	22/12/2017	3354325	17210552.0	German
3354441	Nissei ASB Machine Co., Ltd.	18/10/2012	3354441	18159687.5	
3354917	Kaba Gallenschütz GmbH	11/12/2017	3354917	17206533.6	German
3355650	Huawei Technologies Co., Ltd.	23/10/2015	3355650	15906526.7	
3355832	Porte, Michel Doursounian, Levon	29/09/2016	3355832	16774500.9	French
3356256	Presspart Manufacturing Ltd.	01/10/2015	3356256	15782020.0	
3357109	BYD Company Limited	15/12/2016	3357109	16874876.2	
3357765	Autoliv Development AB	16/09/2016	3357765	16851247.3	
3358887	Industrial Technology Research Institute	21/12/2017	3358887	17209219.9	
3359852	Conti Temic microelectronic GmbH	21/09/2016	3359852	16781060.5	German
3360451	LG Electronics Inc.	21/12/2016	3360451	16882019.9	
3360731	DURA Operating, LLC	10/02/2017	3360731	17155555.0	German
3361108	The Boeing Company	15/12/2017	3361108	17207852.9	
3361383	Hewlett Packard Enterprise Development LP	21/12/2017	3361383	17209412.0	

3361696	Quanta Computer Inc.	15/12/2017	3361696	17207711.7	
3362207	Fraunhofer-Gesellschaft zur Förderung der angewandten Forschung e.V.	13/10/2016	3362207	16782047.1	German
3362319	Renault S.A.S.	06/10/2016	3362319	16787505.3	French
3362796	Aqsens Health Oy	16/10/2016	3362796	16791426.6	
3364102	H4X e.U.	21/12/2017	3364102	17209240.5	German
3364166	STMicroelectronics S.r.l.	14/02/2018	3364166	18156816.3	
3364831	Caffitaly System S.P.A.	07/10/2016	3364831	16797644.8	
3364884	Coremedic AG	19/10/2016	3364884	16785327.4	
3365637	Endress+Hauser Flowtec AG	08/09/2016	3365637	16763032.6	German
3366318	Warsaw Orthopedic, Inc.	24/12/2008	3366318	18164394.1	
3367698	Panasonic Intellectual Property Corporation of America	20/02/2018	3367698	18157568.9	
3368989	Huawei Technologies Co., Ltd.	22/12/2015	3368989	15909601.5	
3369299	Dehondt, Guillaume Dehondt, Guy	03/01/2018	3369299	18150148.7	French
3369368	Peter Osypka Stiftung	08/02/2018	3369368	18020052.9	German
3369837	Nippon Steel Corporation	25/10/2016	3369837	16859809.2	
3369908	Mitsubishi Heavy Industries Engine & Turbocharger, Ltd.	04/12/2015	3369908	15909813.6	
3370462	Huawei Technologies Co., Ltd.	02/12/2016	3370462	16870026.8	
3370568	Colgate-Palmolive Company	12/12/2016	3370568	16822846.8	
3370653	Aesculap AG	07/11/2016	3370653	16791397.9	German
3370687	Beiersdorf AG	17/10/2016	3370687	16782060.4	German
3370830	Colgate-Palmolive Company	07/12/2016	3370830	16813337.9	
3371552	Honeywell International Inc.	02/11/2015	3371552	15791884.8	
3372401	Dow Global Technologies Llc	10/03/2017	3372401	17382121.6	
3372645	Asahi Kasei Kabushiki Kaisha	03/10/2016	3372645	16861761.1	
3373206	Capital One Services, LLC	20/12/2017	3373206	17208790.0	
3374120	Schunk Sonosystems Gmbh	31/10/2016	3374120	16801139.3	German
3374247	Siemens Mobility GmbH	08/12/2016	3374247	16812712.4	German
3375233	Telefonaktiebolaget LM Ericsson (PUBL)	24/09/2015	3375233	15775132.2	
3375675	Valeo Systèmes d'Essuyage	09/03/2018	3375675	18161105.4	French
3376653	R2 Semiconductor Inc.	21/12/2010	3376653	18165947.5	
3377190	Stüwa Konrad Stükerjürgen GmbH	18/11/2016	3377190	16834270.7	German
3378952	Guardant Health, Inc.	24/12/2014	3378952	18156447.7	

3379689	Toyota Jidosha Kabushiki Kaisha	19/03/2018	3379689	18162631.8	
3380446	thyssenkrupp Fertilizer Technology GmbH thyssenkrupp AG	17/12/2016	3380446	16819878.6	German
3381236	Huawei Technologies Co., Ltd.	08/12/2016	3381236	16872416.9	
3381587	Posco	22/12/2015	3381587	15909368.1	
3381954	Kuraray Co., Ltd.	17/04/2014	3381954	18000365.9	
3383116	Huawei Technologies Co., Ltd.	29/12/2016	3383116	16881263.4	
3383161	Redexim Handel-en Exploitatie Maatschappij B.V.	02/12/2016	3383161	16809688.1	German
3383287	Falke Medical Sagl	02/12/2016	3383287	16805456.7	
3383348	CareFusion 303, Inc.	02/12/2016	3383348	16816115.6	
3383349	CareFusion 303, Inc.	01/12/2016	3383349	16819226.8	
3383581	Siemens Aktiengesellschaft	07/12/2016	3383581	16815758.4	German
3383770	Fives Intralogistics S.A.	01/12/2016	3383770	16806045.7	French
3383778	Cyklop S.r.l.	03/12/2015	3383778	15823773.5	
3383820	International Coating Products	05/12/2016	3383820	16819610.3	French
3383969	Adolphe Merkle Institute, University of Fribourg	02/12/2016	3383969	16816222.0	
3383987	Colgate-Palmolive Company	28/12/2015	3383987	15837200.3	
3384061	Constellium Isoire	01/12/2016	3384061	16819147.6	French
3384161	Ateliers Busch S.A.	01/12/2016	3384161	16812913.8	French
3384193	Safran Helicopter Engines	01/12/2016	3384193	16819141.9	French
3384253	Optasense, Inc.	01/12/2016	3384253	16809164.3	
3384308	Swiss Timing Ltd. Friedrich-Alexander-Universität Erlangen-Nürnberg	02/12/2016	3384308	16805437.7	
3384555	Huawei Technologies Co., Ltd.	08/12/2016	3384555	16883384.6	
3384570	Renault S.A.S.	18/11/2016	3384570	16809498.5	French
3384588	Chaoyang Semiconductor Jiangyin Technology Co., Ltd.	12/12/2016	3384588	16874066.0	
3384988	Sharp Life Science (EU) Limited	29/03/2018	3384988	18165231.4	
3385495	Liebherr-Werk Nenzing GmbH	06/12/2017	3385495	17205701.0	German
3386206	Huawei Technologies Co., Ltd.	26/12/2016	3386206	16883435.6	
3386337	The Swatch Group Research and Development Ltd.	05/12/2016	3386337	16808977.9	French
3386397	Bracco Suisse SA	06/12/2016	3386397	16812693.6	

3386616	Outotec (Finland) Oy	08/12/2016	3386616	16816323.6	
3386690	Airbus Group SAS	07/12/2016	3386690	16815897.0	French
3386704	Compagnie Générale des Etablissements Michelin	08/12/2016	3386704	16819618.6	French
3386736	voestalpine Stahl GmbH voestalpine Metal Forming GmbH	12/12/2016	3386736	16825340.9	German
3386844	ArcelorMittal	09/12/2016	3386844	16822899.7	
3386847	ArcelorMittal	09/12/2016	3386847	16840278.2	
3386901	Haulotte Group	03/12/2016	3386901	16819975.0	French
3386974	CISBIO BIOASSAYS Université Paul Sabatier Centre National de la Recherche Scientifique	09/12/2016	3386974	16825810.1	French
3387028	Compagnie Générale des Etablissements Michelin	07/12/2016	3387028	16809755.8	French
3387073	Akzo Nobel Coatings International B.V.	07/12/2016	3387073	16809740.0	
3387246	Pierburg GmbH Ford-Werke GmbH	14/11/2016	3387246	16795067.4	German
3387473	Telefonaktiebolaget LM Ericsson (PUBL)	11/12/2015	3387473	15813580.6	
3387646	Amazon Technologies, Inc.	08/12/2016	3387646	16820072.3	
3387683	Robert Bosch GmbH	28/09/2016	3387683	16770946.8	
3387721	Safran Electrical & Power	05/12/2016	3387721	16819602.0	French
3387821	Samsung Electronics Co., Ltd.	28/12/2016	3387821	16884046.0	
3388088	Wang, Jingning	26/05/2017	3388088	17838406.1	
3388244	Dai Nippon Printing Co., Ltd.	22/12/2016	3388244	16878983.2	
3388259	Bridgestone Corporation	05/12/2016	3388259	16872940.8	
3388261	Bridgestone Corporation	02/12/2016	3388261	16873096.8	
3389314	Huawei Technologies Co., Ltd.	31/12/2015	3389314	15911919.7	
3389315	Huawei Technologies Co., Ltd.	31/12/2015	3389315	15912032.8	
3389574	Oxsitis	10/12/2016	3389574	16829409.8	French
3389681	Institut National De La Recherche Agronomique Université Paris Descartes Université Paris Diderot - Paris 7 Assistance Publique - Hôpitaux de Paris	16/12/2016	3389681	16812752.0	French
3389774	Medtronic Inc.	13/12/2016	3389774	16820121.8	

3389791	Henkel AG & Co. KGaA	09/12/2016	3389791	16809043.9	German
3389911	ESAB AB	05/12/2016	3389911	16809186.6	
3389927	Apex Brands, Inc.	16/12/2016	3389927	16843217.7	
3390119	JOST-Werke Deutschland GmbH	14/12/2016	3390119	16815803.8	German
3390140	Volkswagen AG KUKA Deutschland GmbH	19/12/2016	3390140	16829073.2	German
3390228	Commissariat à l'Énergie Atomique et aux Énergies Alternatives	05/12/2016	3390228	16819604.6	French
3390258	Inventio AG	15/12/2016	3390258	16820221.6	German
3390499	Compagnie Générale des Etablissements Michelin	16/12/2016	3390499	16825533.9	French
3390723	Siemens Mobility Pty Ltd.	17/12/2015	3390723	15820969.2	
3390774	Bristol, Inc., D/B/A Remote Automated Solutions	16/12/2016	3390774	16838046.7	
3390820	Crank Brothers, Inc	06/12/2016	3390820	16815945.7	
3390996	Keep-It Technologies AS	16/12/2016	3390996	16822656.1	
3391051	Universiteit Gent	18/12/2016	3391051	16819056.9	
3391165	ABB Schweiz AG	18/12/2015	3391165	15816157.0	
3391330	InterDigital CE Patent Holdings	08/12/2016	3391330	16816612.2	
3391348	Sensormatic Electronics, LLC	19/12/2016	3391348	16823444.1	
3391353	Delta Dore	13/12/2016	3391353	16808726.0	French
3391403	Nederlandse Organisatie voor toegepast- natuurwetenschappelijk onderzoek TNO	15/12/2016	3391403	16813167.0	
3391462	Samsung Electronics Co., Ltd.	14/12/2016	3391462	16876030.4	
3391472	Safran Electrical & Power	09/12/2016	3391472	16825818.4	French
3391476	A. Steffen AG, Elektrohandel	05/12/2016	3391476	16810074.1	German
3391585	Sagemcom Broadband SAS	12/12/2016	3391585	16819294.6	French
3391620	Visa International Service Association	16/12/2016	3391620	16876873.7	
3391642	GoPro, Inc.	12/12/2016	3391642	16826226.9	
3391680	Orange	13/12/2016	3391680	16825837.4	French
3392044	CANON KABUSHIKI KAISHA	14/03/2018	3392044	18161675.6	
3392377	Posco	19/12/2016	3392377	16876102.1	
3392487	Mitsubishi Heavy Industries Engine & Turbocharger, Ltd.	27/12/2016	3392487	16886541.8	
3392704	Ricoh Company, Ltd.	05/12/2016	3392704	16875449.7	
3392839	INTEL Corporation	12/04/2018	3392839	18167129.8	

3392992	LG Chem, Ltd.	14/07/2017	3392992	17827986.5	
3393076	Ikanos Communications, Inc.	15/09/2007	3393076	18177595.8	
3393281	Philip Morris Products S.A.	21/12/2016	3393281	16822162.0	
3393282	Philip Morris Products S.A.	19/12/2016	3393282	16822449.1	
3393283	Philip Morris Products S.A.	21/12/2016	3393283	16822999.5	
3393639	HurraH SarL	14/12/2016	3393639	16809099.1	
3393727	Safran Electronics & Defense B-Temia Inc.	23/12/2016	3393727	16819115.3	French
3393782	Roll-o-Matic A/S	15/12/2016	3393782	16812742.1	
3393817	Xeikon Prepress N.V.	19/12/2016	3393817	16812963.3	
3393893	Compagnie Plastic Omnium	12/12/2016	3393893	16825823.4	French
3393914	I.M.A. Industria Macchine Automatiche S.p.A.	16/12/2016	3393914	16823344.3	
3393915	I.M.A. Industria Macchine Automatiche S.p.A.	16/12/2016	3393915	16825570.1	
3393931	Focke & Co. (GmbH & Co. KG)	12/12/2016	3393931	16810251.5	German
3393954	Inventio AG	14/12/2016	3393954	16809421.7	German
3393992	Rockwool International A/S	20/12/2016	3393992	16819902.4	
3393997	Saint-Gobain Placo SAS	14/12/2016	3393997	16816339.2	
3394026	PURAC Biochem BV	21/12/2016	3394026	16812969.0	
3394108	SAPPI Netherlands Services B.V.	19/12/2016	3394108	16826304.4	
3394171	Borealis AG	20/12/2016	3394171	16812760.3	
3394361	Xylo Technologies AG	23/12/2015	3394361	15819829.1	
3394365	Lavabre, Vincent L'Atelier du 26 Puech, Maxime Marie, Patrick	14/12/2016	3394365	16809108.0	French
3394379	Allmetal, Inc.	08/03/2018	3394379	18711803.9	
3394411	Wärtsilä Finland Oy	23/12/2015	3394411	15826038.0	
3394502	Sozzi Arredamenti S.p.A.	12/12/2016	3394502	16831731.1	
3394547	Recair B.V.	05/10/2016	3394547	16782101.6	
3394670	Oxford University Innovation Ltd.	20/12/2016	3394670	16823030.8	
3394672	Flint Group Germany GmbH	19/12/2016	3394672	16822444.2	German
3394764	Microchip Technology Incorporated	22/12/2016	3394764	16826827.4	
3394837	Safran Electronics & Defense Safran Landing Systems	20/12/2016	3394837	16812777.7	French
3394867	Supergrid Institute	06/12/2016	3394867	16825455.5	French

3394872	Kinetron B.V.	22/12/2016	3394872	16825588.3	
3394964	NITTY-GRITTY S.R.L.	21/12/2016	3394964	16845362.9	
3395027	Telefonaktiebolaget LM Ericsson (publ)	23/12/2015	3395027	15825965.5	
3395131	Endress+Hauser Flowtec AG	01/12/2016	3395131	16805120.9	German
3395200	Vertiv Integrated Systems GmbH	10/04/2018	3395200	18166528.2	German
3395374	Metall + Plastic GmbH	17/12/2015	3395374	18158935.9	German
3395898	Covestro Deutschland AG	28/04/2017	3395898	17168589.4	German
3396298	Due Emme S.r.l.	11/04/2018	3396298	18166747.8	
3396763	Nissan Motor Co., Ltd.	08/12/2016	3396763	16878405.6	
3396764	NISSAN MOTOR CO., LTD.	30/11/2016	3396764	16878284.5	
3396831	DELTA ELECTRONICS (THAILAND) PUBLIC COMPANY LIMITED	26/04/2017	3396831	17168153.9	
3397011	Huawei Technologies Co., Ltd.	31/12/2015	3397011	15911961.9	
3397084	Philip Morris Products S.A.	22/12/2016	3397084	16819320.9	
3397087	Philip Morris Products S.A.	21/12/2016	3397087	16812979.9	
3397091	Philip Morris Products S.A.	06/12/2016	3397091	16813033.4	
3397094	Philip Morris Products S.A.	13/12/2016	3397094	16819373.8	
3397307	Bracco Injeneering SA	21/12/2016	3397307	16816290.7	
3397363	Sony Interactive Entertainment America LLC	20/12/2016	3397363	16823489.6	
3397408	voestalpine Automotive Components Dettingen GmbH & Co. KG	23/12/2016	3397408	16828948.6	German
3397512	Pirelli Tyre S.p.A.	13/12/2016	3397512	16840317.8	
3397527	Best Wash Bike S.r.l.	22/12/2016	3397527	16831487.0	
3397528	Best Wash Bike S.r.l.	22/12/2016	3397528	16829243.1	
3397541	Compagnie Plastic Omnium	19/12/2016	3397541	16829412.2	French
3397686	Compagnie Générale des Etablissements Michelin	29/12/2016	3397686	16831873.1	
3397703	Kao Corporation	08/12/2016	3397703	16823058.9	
3397785	Arcelormittal	29/12/2015	3397785	15828384.6	
3397821	Christiania Byggeteknikk AS	28/12/2016	3397821	16867426.5	
3397832	M-I Drilling Fluids U.K. Limited	29/12/2016	3397832	16828967.6	
3397883	Technip France	30/12/2016	3397883	16820310.7	French
3398238	Motorola Solutions, Inc.	06/12/2016	3398238	16816129.7	
3398314	Telefonaktiebolaget LM Ericsson (PUBL)	21/12/2016	3398314	16826773.0	

3398409	Beghelli S.p.A.	27/12/2016	3398409	16847628.1	
3398848	Mares S.p.A.	16/04/2018	3398848	18167539.8	
3398872	Kraft Foods Group Brands LLC	06/12/2013	3398872	18178467.9	
3398891	Kolbus GmbH & Co. KG	02/05/2018	3398891	18000420.2	German
3401234	Fasb Linea 2 S.r.l.	11/05/2018	3401234	18171920.4	
3401289	Ningbo Hicren Biotechnology Co., Ltd.	22/12/2016	3401289	16883418.2	
3401732	Folex AG	11/05/2017	3401732	17170540.3	German
3402175	LG Electronics Inc.	04/12/2015	3402175	18181099.5	
3402304	Huawei Technologies Co., Ltd.	24/06/2016	3402304	16887491.5	
3402614	Guasta, Fabrizio	28/12/2016	3402614	16829438.7	
3403042	NEXTER Systems	22/12/2016	3403042	16831897.0	French
3403262	Google LLC	29/12/2016	3403262	16829208.4	
3405609	BSH Hausgeräte GmbH	17/10/2016	3405609	16788647.2	German
3405653	Turboden SPA	18/01/2017	3405653	17704540.8	
3405961	Johnson Matthey Public Limited Company	21/12/2016	3405961	16822236.2	
3406233	The Procter & Gamble Company	24/05/2017	3406233	17172881.9	
3406428	BOGE Elastmetall GmbH	23/05/2018	3406428	18173810.5	German
3406661	Sumitomo Rubber Industries, Ltd.	03/12/2013	3406661	18183863.2	
3406963	Blueview Elec-Optic Tech Co., Ltd	21/04/2017	3406963	17844648.0	
3407505	Huawei Technologies Co., Ltd.	05/04/2016	3407505	16897516.7	
3408040	Dörr, Wolfgang	12/12/2016	3408040	16829231.6	German
3408634	Robert Bosch GmbH	30/11/2016	3408634	16804798.3	German
3408635	Primetals Technologies Germany GmbH	02/12/2016	3408635	16805807.1	German
3408721	Moulene, Daniel	27/01/2017	3408721	17706580.2	French
3409481	OCE Holding B.V.	24/05/2018	3409481	18173953.3	
3409542	MAN Truck & Bus SE	16/05/2018	3409542	18172520.1	German
3409858	CCOMM Group Ltd	18/05/2018	3409858	18173338.7	
3410186	CANON KABUSHIKI KAISHA	30/05/2018	3410186	18175008.4	
3410197	CANON KABUSHIKI KAISHA	30/05/2018	3410197	18175083.7	
3410540	Aptiv Technologies Limited	29/05/2017	3410540	17173210.0	
3410694	GUANGDONG OPPO MOBILE TELECOMMUNICATIONS CORP., LTD.	15/03/2018	3410694	18161908.1	
3410729	The Nielsen Company (US), LLC	02/12/2014	3410729	18183587.7	
3410781	BlackBerry Limited	21/12/2009	3410781	18162817.3	

3411123	Akuis S.r.l.	20/12/2016	3411123	16819317.5	
3411288	Nicoli, Eliseo	19/12/2016	3411288	16822279.2	
3411825	Symantec Corporation	28/12/2016	3411825	16829470.0	
3412589	Kraft Foods Group Brands LLC	06/12/2013	3412589	18178469.5	
3412668	Vertex Pharmaceuticals Incorporated	25/09/2014	3412668	18180366.9	
3412789	JFE Steel Corporation	17/03/2017	3412789	17774414.1	
3413525	NXP B.V.	29/05/2018	3413525	18174900.3	
3413612	KDDI Corporation	12/12/2016	3413612	16889415.2	
3414778	SMA Solar Technology AG	08/12/2016	3414778	16816227.9	German
3414848	Telefonaktiebolaget LM Ericsson (PUBL)	05/12/2016	3414848	16809333.4	
3415773	SFS Intec Holding AG	15/06/2017	3415773	17176163.8	German
3416062	Huawei Technologies Co., Ltd.	11/03/2016	3416062	16893073.3	
3416130	GUANGDONG OPPO MOBILE TELECOMMUNICATIONS CORP., LTD.	08/06/2018	3416130	18176676.7	
3416443	Sun Patent Trust	04/12/2013	3416443	18180846.0	
3417591	Orange	10/02/2017	3417591	17709140.2	French
3418024	NSK Ltd.	19/02/2016	3418024	16890578.4	
3420197	Siemens Aktiengesellschaft	11/04/2017	3420197	17717143.6	German
3420266	Lumileds LLC	21/02/2017	3420266	17757064.5	
3420635	Xilinx, Inc.	06/12/2016	3420635	16816831.8	
3421055	Tersano Inc.	20/08/2012	3421055	18189561.6	
3421450	The University Of Liverpool	23/12/2014	3421450	18190104.2	
3422239	Sagemcom Energy & Telecom SAS	25/06/2018	3422239	18179657.4	French
3422747	NEC Corporation	21/03/2008	3422747	18189579.8	
3422981	Creo Medical Limited	02/03/2017	3422981	17708260.9	
3422997	Water Pik, Inc.	02/03/2017	3422997	17711914.6	
3423165	Wacker Chemie AG	21/02/2017	3423165	17707502.5	German
3423414	Cameron Solutions, Inc.	13/02/2017	3423414	17710079.9	
3424277	Signify Holding B.V.	22/02/2017	3424277	17705671.0	
3426742	Dow Silicones Corporation Dow Toray Co., Ltd.	07/03/2017	3426742	17714320.3	
3426895	Siemens Aktiengesellschaft	12/04/2017	3426895	17717160.0	German
3426918	Siemens Aktiengesellschaft	20/03/2017	3426918	17714376.5	
3427074	Fraunhofer-Gesellschaft zur Förderung der angewandten Forschung e.V.	13/04/2017	3427074	17717186.5	

3427406	Huawei Technologies Co., Ltd.	23/03/2016	3427406	16711640.9	
3429273	Huawei Technologies Co., Ltd.	01/04/2016	3429273	16896103.5	
3429308	BlackBerry Limited	06/12/2002	3429308	18192276.6	
3429355	Bayer CropScience AG	08/03/2017	3429355	17708548.7	German
3430257	Uptime Holding GmbH	04/01/2017	3430257	17701635.9	German
3430701	Vorwerk & Co. Interholding GmbH	14/03/2017	3430701	17713187.7	German
3431921	3Shape A/S	05/12/2011	3431921	18192674.2	
3432186	AO Kaspersky Lab	20/03/2018	3432186	18162957.7	
3433739	NetApp, Inc.	24/03/2017	3433739	17717950.4	
3434001	Zhejiang Geely Holding Group Co., Ltd. Zhejiang Geely Automobile Research Institute Co., Ltd.	13/01/2017	3434001	17792359.6	
3434047	Telefonaktiebolaget LM Ericsson (PUBL)	24/03/2017	3434047	17714907.7	
3434188	Bayer Aktiengesellschaft	25/07/2017	3434188	17183069.8	
3434972	HMB Ges.m.b.H.	03/07/2018	3434972	18181492.2	German
3435258	Intel Corporation	27/06/2013	3435258	18195171.6	
3438765	ETA SA Manufacture Horlogère Suisse	04/08/2017	3438765	17184983.9	French
3440405	Clyde Bergemann Drycon GmbH	13/03/2017	3440405	17710254.8	German
3440639	Huf Hülsbeck & Fürst GmbH & Co. KG	06/04/2017	3440639	17719187.1	German
3440897	Signify Holding B.V.	29/03/2017	3440897	17714210.6	
3440954	Unitech Zipper & Machinery Co., Ltd.	13/06/2018	3440954	18177530.5	
3441439	Kureha Corporation	28/02/2017	3441439	17778898.1	
3441452	Martin GmbH für Umwelt- und Energietechnik	19/06/2018	3441452	18000536.5	German
3441466	Seikagaku Corporation	10/12/2013	3441466	18190686.8	
3442124	Siemens Aktiengesellschaft	07/08/2017	3442124	17185083.7	German
3442171	Orange	14/12/2012	3442171	18198283.6	French
3442344	Caravan Ingredients Inc.	14/04/2017	3442344	17732264.1	
3442386	Koninklijke Philips N.V.	29/03/2017	3442386	17713035.8	
3442632	Aptar France SAS	13/04/2017	3442632	17723447.3	French
3442633	Aptar France SAS	13/04/2017	3442633	17723448.1	French
3443708	GSC Secrypt, LLC Accenture Global Solutions Limited	23/05/2017	3443708	17724088.4	

3443709	Accenture Global Solutions Limited GSC Secrypt, LLC	23/05/2017	3443709	17724089.2	
3443710	Accenture Global Solutions Limited GSC Secrypt, LLC	23/05/2017	3443710	17725936.3	
3443783	Google LLC	29/12/2016	3443783	16831872.3	
3444049	S.A.S 3DCeram-Sinto	20/06/2018	3444049	18178869.6	French
3444104	PackSys Global AG	17/08/2017	3444104	17186735.1	German
3445109	Huawei Technologies Co., Ltd.	10/05/2016	3445109	16901238.2	
3445927	Diarnet S.r.l.	06/04/2017	3445927	17731654.4	
3448216	Aktiebolaget Electrolux	27/04/2016	3448216	16718692.3	
3449605	Fairflow Technologies Holding B.V.	25/04/2017	3449605	17723288.1	
3449726	Werner & Pfleiderer Lebensmitteltechnik GmbH	17/08/2018	3449726	18189534.3	German
3450167	XYZprinting, Inc. Kinpo Electronics, Inc.	29/12/2017	3450167	17211214.6	
3451740	Huawei Technologies Co., Ltd.	12/12/2013	3451740	18184205.5	
3454059	Riken Keiki Co., Ltd.	31/08/2018	3454059	18191870.7	
3454355	CARLING TECHNOLOGIES, Inc.	07/05/2018	3454355	18171065.8	
3454561	Samsung Electronics Co., Ltd.	14/09/2012	3454561	18202093.3	
3454788	St. Jude Medical, Cardiology Division, Inc.	11/05/2017	3454788	17725422.4	
3455557	B.S. Service S.r.l.	07/07/2016	3455557	16763096.1	
3455637	Centre National de la Recherche Scientifique Université de Lille 1 Sciences et Technologies	09/05/2017	3455637	17722743.6	French
3455679	LVMH Swiss Manufactures SA	19/04/2017	3455679	17718753.1	French
3456086	Huawei Technologies Co., Ltd.	07/06/2017	3456086	17809723.4	
3457588	CommScope Technologies LLC	22/06/2009	3457588	18192570.2	
3457824	Magneti Marelli S.p.A.	27/07/2018	3457824	18186139.4	
3457889	Autostore Technology AS	18/05/2017	3457889	17724352.4	
3458255	Compagnie Générale des Etablissements Michelin	03/05/2017	3458255	17720160.5	
3458280	Ivanchenko, Yaroslav Shulha, Andrii	28/09/2016	3458280	16810508.8	
3458514	Borealis AG	16/05/2017	3458514	17724530.5	
3459124	Lumileds Holding B.V.	16/05/2017	3459124	17722836.8	

3463955	Elkamet Kunststofftechnik GmbH	16/05/2017	3463955	17723699.9	German
3464295	Merck Patent GmbH	22/05/2017	3464295	17724570.1	
3466283	Shenzhen Smoore Technology Limited	23/12/2015	3466283	18207525.9	
3467610	Stuhl Regelsysteme GmbH	09/10/2017	3467610	17195519.8	German
3468239	Huawei Technologies Co., Ltd.	04/07/2016	3468239	16907724.5	
3469352	Tankbots, Inc.	15/12/2017	3469352	17829417.9	
3469579	Google LLC	09/12/2016	3469579	16816156.0	
3472088	Conductix-Wampfler GmbH	03/05/2018	3472088	18722030.6	German
3473795	C.C.E. Costruzioni Chiusure Ermetiche S.r.l.	22/10/2018	3473795	18201794.7	
3475582	Truflor Air Movement Ltd	26/06/2017	3475582	17737018.6	
3476083	Harting Electric GmbH & Co. KG	08/06/2017	3476083	17740277.3	German
3476952	Northeastern University	28/04/2017	3476952	17854409.4	
3479505	Telefonaktiebolaget LM Ericsson (publ)	30/06/2016	3479505	16745208.5	
3480023	Brother Kogyo Kabushiki Kaisha	04/12/2012	3480023	18208670.2	
3486171	AIRBUS HELICOPTERS DEUTSCHLAND GmbH	20/11/2017	3486171	17400068.7	
3495544	Trützschler GmbH & Co. KG	12/10/2018	3495544	18200089.3	German
3497838	QUALCOMM Incorporated	04/08/2017	3497838	17757949.7	
3498226	Edwards Lifesciences Corporation	05/10/2011	3498226	19154572.2	
3500229	Koninklijke Philips N.V.	05/03/2018	3500229	18708984.2	
3501902	Thule Sweden AB	19/12/2017	3501902	17208324.8	
3501903	Thule Sweden AB	19/12/2017	3501903	17208327.1	
3501974	LEONARDO S.p.A.	19/12/2017	3501974	17208693.6	
3501983	LEONARDO S.p.A.	22/12/2017	3501983	17210094.3	
3502005	TECAN TRADING AG	20/12/2017	3502005	17209048.2	German
3502380	SimonsVoss Technologies GmbH	20/12/2017	3502380	17209088.8	German
3503472	Huawei Technologies Co., Ltd.	29/09/2017	3503472	17862941.6	
3503554	JVC Kenwood Corporation	14/12/2012	3503554	19156821.1	
3503601	Deutsche Telekom AG	22/12/2017	3503601	17210081.0	
3503609	Deutsche Telekom AG	22/12/2017	3503609	17210124.8	
3512704	Additive Industries B.V.	18/09/2017	3512704	17781573.5	
3515027	Telefonaktiebolaget LM Ericsson (publ)	29/12/2014	3515027	19150427.3	
3515636	Element Six GmbH	16/08/2018	3515636	18755475.3	
3516136	EMKA BESCHLAGTEILE GmbH & Co. KG	20/09/2016	3516136	16770912.0	
3519902	Comadur S.A.	15/11/2017	3519902	17808805.0	French

3520574	Signify Holding B.V.	21/09/2017	3520574	17780654.4	
3526012	Signify Holding B.V.	09/10/2017	3526012	17781106.4	
3529804	Google LLC	03/08/2018	3529804	18756127.9	
3534574	Deutsche Telekom AG	28/02/2018	3534574	18159123.1	
3538675	Paul Wurth S.A.	08/11/2017	3538675	17794730.6	
3542363	Google LLC	15/03/2018	3542363	18715866.2	
3554721	Kucharska, Beate	11/12/2018	3554721	18832983.3	German

Grants Published in EPO Bulletin No. 07/20, dated 12th February 2020

1325582	Nokia Technologies Oy	10/10/2001	1325582	01974579.3	
1391801	Microsoft Technology Licensing, LLC	15/04/2003	1391801	03008702.7	
1436925	Rakuten, Inc.	18/10/2002	1436925	02802800.9	
1497229	Ondeo Degremont, Inc.	01/04/2003	1497229	03746101.9	
1524596	Microsoft Technology Licensing, LLC	12/08/2004	1524596	04103892.8	
1552324	IFP Energies nouvelles GDF SUEZ CGGVERITAS SERVICES SA	01/10/2003	1552324	03775458.7	French
1565951	Evonik Operations GmbH	06/11/2003	1565951	03811750.3	German
1623596	Nokia Technologies Oy	12/05/2004	1623596	04732363.9	
1624709	Alcatel Lucent	12/07/2005	1624709	05106371.7	French
1654111	Siemens Medical Solutions USA, Inc.	28/05/2004	1654111	04753788.1	
1654201	SAINT-GOBAIN GLASS FRANCE	21/07/2004	1654201	04785986.3	French
1674965	Microsoft Technology Licensing, LLC	07/12/2005	1674965	05111766.1	
1692729	Cree, Inc.	24/11/2004	1692729	04812190.9	
1703273	BAM Bundesanstalt für Materialforschung und -prüfung	15/03/2006	1703273	06111147.2	German
1754044	Finesse Solutions, Inc.	26/05/2005	1754044	05753805.0	
1754349	Cisco Technology, Inc.	03/03/2005	1754349	05857867.5	
1774590	SIGE Semiconductor Inc	27/05/2005	1774590	05745367.2	
1782246	Sciencelogic, LLC	07/07/2005	1782246	05771583.1	
1786338	Seex, Kevin	13/08/2005	1786338	05771803.3	
1789023	NANO-4-U AG	07/09/2005	1789023	05783096.0	
1824805	Futurechem Co., Ltd. The Asan Foundation	09/12/2005	1824805	05821819.9	
1827254	Smith and Nephew, Inc.	21/12/2005	1827254	05855427.0	
1828695	Clarion Technologies, Inc. Magna Mirrors of America, Inc.	13/10/2005	1828695	05813306.7	
1843271	DePuy Products, Inc.	10/04/2007	1843271	07251542.2	
1850745	Koninklijke Philips N.V.	30/12/2005	1850745	05849944.3	
1850761	De Soutter Medical Limited Smith & Nephew plc	21/02/2006	1850761	06709840.0	
1856784	NXP USA, Inc.	22/02/2005	1856784	05708797.5	
1864172	British Telecommunications public limited company	29/03/2006	1864172	06726543.9	

1871948	Devan-Micropolis SA	27/02/2006	1871948	06765654.6	
1879553	ALLERGAN, INC.	09/05/2006	1879553	06752463.7	
1887864	NOVAPHARM RESEARCH (AUSTRALIA) PTY. LIMITED	28/04/2006	1887864	06721433.8	
1895936	ArgentumCidalElectrics, Inc.	30/06/2006	1895936	06774470.6	
1908091	Systec System- und Anlagentechnik GmbH & Co. KG	11/07/2006	1908091	06762519.4	German
1914954	Swisscom AG	17/10/2006	1914954	06122426.7	German
1919497	The Board of Trustees of the Leland Stanford Junior University	24/07/2006	1919497	06824781.6	
1928342	Intuitive Surgical Operations, Inc.	26/09/2006	1928342	06815435.0	
1937468	LM Wind Power A/S	14/09/2006	1937468	06775991.0	
1940004	ROBERT BOSCH GMBH	21/12/2007	1940004	07024927.1	German
1941453	Bracco Imaging S.P.A.	24/10/2006	1941453	06819131.1	
1945311	RIC Investments, LLC.	24/10/2006	1945311	06836479.3	
1949581	Google Technology Holdings LLC	26/10/2006	1949581	06826689.9	
1992104	Orange	06/03/2007	1992104	07731702.2	French
2007170	Shandong Gettop Acoustic Co., Ltd	20/06/2008	2007170	08158672.9	
2018423	Novozymes A/S	03/05/2007	2018423	07728737.3	
2020742	Vacon Oy	19/05/2008	2020742	08075493.0	
2032221	Dent, Kyle Graham John	08/06/2007	2032221	07733146.0	
2033227	WISCONSIN ALUMNI RESEARCH FOUNDATION	15/05/2007	2033227	07762196.9	
2033834	ALSTOM Transport Technologies	01/09/2008	2033834	08163382.8	French
2050299	Qualcomm Incorporated	12/07/2007	2050299	07812870.9	
2061805	Macfarlane Burnet Institute for Medical Research and Public Health Limited	24/08/2007	2061805	07784854.7	
2064730	Cree, Inc.	04/03/2008	2064730	08742018.8	
2066699	Archer-Daniels-Midland Company	25/09/2007	2066699	07815922.5	
2080350	Nokia Technologies Oy	08/08/2007	2080350	07805350.1	
2084319	Koninklijke Philips N.V.	02/10/2007	2084319	07826613.7	
2087643	Nokia of America Corporation	22/10/2007	2087643	07873893.7	
2092767	Cisco Technology, Inc.	07/12/2007	2092767	07869040.1	
2103080	Vodafone Holding GmbH	13/12/2007	2103080	07856692.4	German
2104199	TOYOTA JIDOSHA KABUSHIKI KAISHA	26/12/2007	2104199	07860585.4	

2117794	STRATIFIED CONCRETE TECHNOLOGIES LIMITED	14/12/2007	2117794	07866870.4	
2118042	Anuvia Plant Nutrients Holdings LLC	19/02/2008	2118042	08730174.3	
2120225	Life Safety Distribution AG	01/05/2009	2120225	09159281.6	
2122712	LG Chem, Ltd.	07/11/2007	2122712	07833902.5	
2123121	Electrolux Home Products Corporation N.V.	01/12/2007	2123121	07846936.8	
2123467	Mars Incorporated	01/06/2001	2123467	09075346.8	
2125420	Volvo Lastvagnar AB	21/02/2007	2125420	07709365.6	
2131701	L&P Property Management Company	04/04/2008	2131701	08742567.4	
2134710	Intra-Cellular Therapies, Inc.	12/03/2008	2134710	08742074.1	
2135840	Honeywell International Inc.	14/06/2009	2135840	09162649.9	
2136425	Samsung SDI Co., Ltd.	15/06/2009	2136425	09162704.2	
2140923	Baldwin Filters, Inc.	24/06/2009	2140923	09163616.7	
2141528	CommScope Connectivity Belgium BVBA	02/07/2009	2141528	09251715.0	
2145051	SUEZ Groupe	23/04/2008	2145051	08805500.9	French
2148257	Honeywell International Inc.	07/07/2009	2148257	09164837.8	
2153631	Nokia Technologies Oy	20/06/2007	2153631	07734947.0	
2154942	Fytagoras B.V.	12/06/2008	2154942	08766793.7	
2158724	Microsoft Technology Licensing, LLC	21/05/2008	2158724	08756076.9	
2160077	Legrand Electric Limited	28/08/2009	2160077	09168977.8	
2162033	Securoseal Holding Inc.	19/06/2008	2162033	08756965.3	
2166664	Siemens Gamesa Renewable Energy A/S	17/09/2008	2166664	08016397.5	
2172261	Corning Incorporated	22/10/2008	2172261	08305711.7	
2175212	Daikin Industries, Ltd.	11/06/2008	2175212	08764088.4	
2175344	Samsung Electronics Co., Ltd.	10/08/2009	2175344	09167533.0	
2178186	INTILION GmbH	01/08/2009	2178186	09009962.3	German
2182165	Halliburton Energy Services, Inc.	12/05/2009	2182165	09275034.8	
2190162	ZTE Corporation	03/09/2007	2190162	07800846.3	
2191214	BSH Hausgeräte GmbH	12/08/2008	2191214	08802997.0	German
2191300	GTC, Inc.	19/09/2008	2191300	08831527.0	
2193640	Panasonic Corporation	29/08/2008	2193640	08828338.7	
2194394	Verint Systems Ltd.	01/12/2009	2194394	09252713.4	
2197408	Alterg, Inc.	15/10/2008	2197408	08838964.8	
2198540	Telefonaktiebolaget LM Ericsson (publ)	19/09/2007	2198540	07835251.5	

2200910	Envac AB	16/09/2008	2200910	08832324.1	
2202646	Ricoh Company, Ltd.	08/12/2009	2202646	09178280.5	
2207685	Hewlett-Packard Development Company, L.P.	11/06/2008	2207685	08770659.4	
2207966	THE CLEVELAND CLINIC FOUNDATION	18/10/2007	2207966	07871182.7	
2211516	Apple Inc.	15/10/2002	2211516	10161516.9	
2216062	Japan Tobacco Inc.	19/11/2008	2216062	08857231.8	
2219425	WABCO GmbH	17/09/2009	2219425	09011837.3	German
2220852	Cisco Technology, Inc.	23/10/2008	2220852	08845826.0	
2223079	Koninklijke Philips N.V.	08/12/2008	2223079	08859914.7	
2224556	Yazaki Corporation	16/12/2008	2224556	08865126.0	
2234447	Apple Inc.	23/03/2010	2234447	10157318.6	
2234694	Sustainable Energy Solutions, LLC	28/11/2008	2234694	08855143.7	
2235742	Solvay Fluor GmbH	16/12/2008	2235742	08863791.3	
2237968	Giesecke+Devrient Currency Technology GmbH	17/12/2008	2237968	08867406.4	German
2245603	FEDRIGONI S.P.A.	24/06/2008	2245603	08761336.0	
2246666	BlackBerry Limited	29/04/2009	2246666	09159125.5	
2247480	Nissan Motor Co., Ltd.	27/02/2009	2247480	09717672.1	
2250414	Gomes, Fernandes Paulo Roberto	04/03/2009	2250414	09718125.9	
2251446	General Electric Company	07/05/2010	2251446	10162318.9	
2254389	Panasonic Intellectual Property Corporation of America	12/03/2009	2254389	09720582.7	
2259746	Neocis, Llc	01/04/2009	2259746	09727058.1	
2262844	Compart SAS IFP Energies nouvelles	27/03/2009	2262844	09738295.6	French
2264496	Brendel Holding GmbH & Co. KG	14/06/2010	2264496	10165836.7	German
2269409	Cisco Technology, Inc.	16/04/2009	2269409	09732421.4	
2270324	Nissan Motor Co., Ltd.	04/06/2010	2270324	10164919.2	
2271013	Deutsche Telekom AG	30/06/2010	2271013	10006742.0	German
2271059	TCL Communication Technology Holdings Ltd.	03/04/2009	2271059	09730015.6	
2273553	IMEC VZW	30/06/2005	2273553	10185047.7	
2278034	Nippon Steel Corporation	13/04/2009	2278034	09732579.9	
2280214	Koito Manufacturing Co., Ltd.	26/05/2009	2280214	09754705.3	
2280539	Samsung Electronics Co., Ltd.	23/07/2010	2280539	10170583.8	

2280770	Polar Electro Oy	27/03/2009	2280770	09725858.6	
2288426	Rhodia Opérations	21/04/2009	2288426	09735495.5	French
2290493	LG Electronics Inc.	01/07/2010	2290493	10006803.0	
2290879	General Electric Company	05/08/2010	2290879	10171954.0	
2291220	Bioness Inc.	24/06/2009	2291220	09770922.4	
2291499	BASF AS	15/05/2009	2291499	09746818.5	
2291782	Chevron U.S.A., Inc.	15/06/2009	2291782	09767545.8	
2293017	BlackBerry Limited	29/04/2009	2293017	10191092.5	
2294228	Compagnie Industrielle De La Matiere Vegetale CIMV	03/06/2009	2294228	09779622.1	
2294299	ExxonMobil Upstream Research Company	09/04/2009	2294299	09758863.6	
2294491	Avantium Technologies B.V.	26/05/2009	2294491	09755071.9	
2303100	United States Endoscopy Group, Inc.	15/04/2009	2303100	09731691.3	
2306028	Sundyne LLC	07/12/2005	2306028	10015752.8	
2306169	Bundesanstalt für Materialforschung und -prüfung (BAM)	01/10/2010	2306169	10185936.1	German
2310003	Meta-IQ APS	25/06/2009	2310003	09769327.9	
2310343	Palaterra GmbH & Co. KG	12/06/2009	2310343	09761507.4	German
2310752	CAMFIL AB	26/05/2009	2310752	09770472.0	
2315983	SENS Geoenergy Storage AB	07/05/2009	2315983	09746859.9	
2316048	IP2IPO Innovations Limited	20/07/2009	2316048	09784754.5	
2317942	Stryker Corporation	12/06/2009	2317942	09763758.1	
2324882	Starlab Barcelona SL	13/08/2009	2324882	09806467.8	
2325569	Panasonic Corporation	13/10/2010	2325569	10187447.7	
2327237	Microsoft Technology Licensing, LLC	15/09/2009	2327237	09813792.0	
2327973	NEXION S.p.A.	18/11/2010	2327973	10191700.3	
2328634	Bracco Diagnostics Inc.	11/06/2009	2328634	09763612.0	
2334475	BIC Violex S.A.	01/10/2008	2334475	08804976.2	
2337263	NXP B.V.	17/12/2009	2337263	09179628.4	
2338186	Universal Display Corporation Idemitsu Kosan Co., Ltd.	23/10/2008	2338186	08876424.6	
2341293	BSH Hausgeräte GmbH	22/12/2010	2341293	10196395.7	German
2346198	BlackBerry Limited	19/08/2008	2346198	11162474.8	
2347076	Julius Blum GmbH	07/09/2009	2347076	09775626.6	German
2347350	Rakuten, Inc.	08/10/2009	2347350	09752219.7	
2348268	BSH Hausgeräte GmbH	04/11/2009	2348268	09764580.8	

2349069	Braun GmbH	04/11/2009	2349069	09759799.1	
2349536	General Electric Technology GmbH	06/11/2009	2349536	09752960.6	
2351175	Corning Research & Development Corporation	28/09/2009	2351175	09793045.7	
2361658	BANDAI NAMCO Entertainment Inc.	21/02/2011	2361658	11155133.9	
2362065	Rolls-Royce Deutschland Ltd & Co KG	16/02/2011	2362065	11001266.3	German
2362357	Stoneridge Electronics AB	22/02/2010	2362357	10154288.4	
2365374	Visual Physics, LLC	18/05/2006	2365374	11003625.8	
2368204	Qinetiq Limited	15/12/2009	2368204	09799682.1	
2373938	BSH Hausgeräte GmbH	08/12/2009	2373938	09775153.1	
2374089	Nokia Technologies Oy	14/12/2009	2374089	09836140.5	
2374422	Covidien LP	11/04/2011	2374422	11250454.3	
2375163	General Electric Company	05/04/2011	2375163	11161159.6	
2375344	Accenture Global Services Limited	08/04/2010	2375344	10305362.5	
2376880	Totalförsvarets Forskningsinstitut FOI	17/12/2009	2376880	09833742.1	
2377501	Corman S.p.A.	10/11/2010	2377501	10190691.5	
2378200	General Electric Company	15/04/2011	2378200	11162744.4	
2378977	Volcano Corporation	18/12/2009	2378977	09837988.6	
2378980	Allflex Europe	18/12/2009	2378980	09796715.2	French
2380327	QUALCOMM Incorporated	28/12/2009	2380327	09804220.3	
2380971	Mesoblast, Inc.	29/03/2004	2380971	11159624.3	
2381931	Flamel Ireland Limited	18/12/2009	2381931	09805748.2	French
2384450	Kietta	29/12/2009	2384450	09806032.0	
2385858	Koninklijke Philips N.V.	15/12/2009	2385858	09801276.8	
2388243	Dow Global Technologies LLC	06/05/2011	2388243	11165043.8	
2388836	Seoul Viosys Co., Ltd	17/05/2011	2388836	11166366.2	
2397198	Nintendo Co., Ltd.	01/12/2010	2397198	10193313.3	
2398202	Samsung Electronics Co., Ltd.	16/02/2010	2398202	10741433.6	
2399522	Esaote S.p.A.	14/06/2011	2399522	11169885.8	
2407602	TOTO LTD.	12/07/2011	2407602	11173705.2	
2407929	Omron Corporation	22/02/2010	2407929	10750494.6	
2409422	Koninklijke Philips N.V.	16/03/2010	2409422	10712542.9	
2410203	Fox Factory, Inc.	22/07/2011	2410203	11175126.9	
2410912	Mardil, Inc.	26/03/2010	2410912	10756911.3	
2413805	Boston Scientific Scimed, Inc.	24/03/2010	2413805	10728462.2	
2414321	3M Innovative Properties Company	19/03/2010	2414321	10762086.6	
2415029	Inventio AG	01/04/2010	2415029	10713326.6	German

2415318	Nokia Solutions and Networks Oy	31/03/2009	2415318	09779233.7
2416142	SYSMEX CORPORATION	27/07/2011	2416142	11175542.7
2416471	TOYOTA JIDOSHA KABUSHIKI KAISHA	18/12/2009	2416471	09851549.7
2416844	Boston Scientific Neuromodulation Corporation	26/03/2010	2416844	10712231.9
2417432	Schlumberger Technology Corporation	09/04/2010	2417432	10762511.3
2418797	ZTE (USA), Inc.	12/08/2011	2418797	11177509.4
2419329	The Boeing Company	13/04/2010	2419329	10714776.1
2420764	Mitsubishi Electric Corporation	17/04/2009	2420764	09843336.0
2421347	Rockwell Automation Technologies, Inc.	22/08/2011	2421347	11178347.8
2422719	Argon Medical Devices, Inc.	11/08/2011	2422719	11177289.3
2423138	NCR Corporation	25/07/2011	2423138	11175212.7
2423768	Rockwell Automation Technologies, Inc.	31/08/2011	2423768	11179558.9
2424060	ABB Schweiz AG	25/08/2011	2424060	11178937.6
2424221	Sony Corporation	27/07/2011	2424221	11175649.0
2427299	Pemamek OY	04/05/2010	2427299	10772060.9
2427969	Telefonaktiebolaget LM Ericsson (publ)	04/12/2009	2427969	09795371.5
2429232	ZTE Corporation	11/12/2009	2429232	09844295.7
2429745	Iscar Ltd.	25/04/2010	2429745	10721570.9
2430430	Smiths Detection Inc.	10/05/2010	2430430	10722227.5
2431960	Honeywell International Inc.	13/09/2011	2431960	11181146.9
2433201	Sony Interactive Entertainment Inc.	13/05/2010	2433201	10778129.6
2433729	Big Daishowa Co., Ltd.	14/05/2010	2433729	10777706.2
2434129	Delavan Inc.	09/09/2011	2434129	11250765.2
2434357	Siemens Aktiengesellschaft	22/09/2010	2434357	10178343.9
2434529	IMEC VZW	28/09/2010	2434529	10181355.8
2434658	CommScope Technologies LLC	22/09/2011	2434658	11182359.7
2434722	QUALCOMM Incorporated	28/05/2009	2434722	11195418.6
2436139	Huawei Technologies Co., Ltd.	24/08/2009	2436139	09848601.2
2436319	Covidien LP	09/09/2011	2436319	11250785.0
2438168	Halo-Bio Rnai Therapeutics, Inc.	01/06/2010	2438168	10783959.9
2438311	Diamond Offshore Company	04/06/2010	2438311	10784167.8
2438635	International Business Machines Corporation	17/08/2010	2438635	10744585.0

German

2439710	Cooper Security Limited	05/10/2011	2439710	11183945.2	
2440882	Ab Initio Technology LLC	09/06/2010	2440882	10786799.6	
2441260	EMC Corporation	07/06/2010	2441260	10786489.4	
2444738	BSH Hausgeräte GmbH	19/10/2011	2444738	11185753.8	German
2444770	ABB Schweiz AG	20/10/2010	2444770	10188165.4	
2444823	THALES	11/10/2011	2444823	11184653.1	French
2445413	INVIVO CORPORATION	23/06/2010	2445413	10791111.7	
2446112	Dreco Energy Services ULC	22/06/2010	2446112	10791102.6	
2446221	Rheinmetall Waffe Munition GmbH	23/06/2010	2446221	10792588.5	
2448696	MAGMA Giessereitechnologie GmbH	28/06/2010	2448696	10730709.2	
2448706	Kapman AB	02/07/2010	2448706	10794464.7	
2449950	Fujifilm Corporation	12/10/2011	2449950	11184808.1	
2450338	Nippon Shokubai Co., Ltd.	24/06/2010	2450338	10794060.3	
2450634	BSH Hausgeräte GmbH	26/10/2011	2450634	11186614.1	German
2452355	DH Technologies Development Pte. Ltd.	05/07/2010	2452355	10796618.6	
2452765	Sintokogio, Ltd. Fujiwa Denki Co., Ltd.	15/06/2010	2452765	10796996.6	
2453838	L'Oréal	16/07/2010	2453838	10742281.8	
2455816	Ricoh Company, Ltd.	14/11/2011	2455816	11188934.1	
2456729	Schott AG	13/07/2010	2456729	10734044.0	German
2458563	Scania CV AB	08/11/2011	2458563	11188159.5	
2460079	EMC Corporation	30/07/2010	2460079	10740101.0	
2460296	SubCom, LLC	30/07/2010	2460296	10805098.0	
2461573	Canon Kabushiki Kaisha	02/12/2011	2461573	11191791.0	
2463173	CRRC Tangshan Co., Ltd.	03/06/2010	2463173	10838375.3	
2463721	Canon Kabushiki Kaisha	09/12/2011	2463721	11192881.8	
2465836	Nippon Shokubai Co., Ltd.	10/08/2010	2465836	10808217.3	
2465994	BSH Hausgeräte GmbH	06/12/2011	2465994	11192133.4	German
2467657	BSH Hausgeräte GmbH	16/08/2010	2467657	10743125.6	German
2468050	Nokia Technologies Oy	17/08/2010	2468050	10809612.4	
2469474	Dassault Systèmes	24/12/2010	2469474	10016070.4	
2469947	ZTE Corporation	30/06/2010	2469947	10819835.9	
2471619	Sandvik Intellectual Property AB	07/12/2011	2471619	11192375.1	
2471735	Mitsubishi Electric Corporation	28/08/2009	2471735	09848740.8	
2472236	Hitachi Automotive Systems, Ltd.	28/12/2011	2472236	11195862.5	
2473124	Applied Medical Resources Corporation	31/08/2010	2473124	10752681.6	

2475013	LG Innotek Co., Ltd.	30/09/2010	2475013	10820854.7	
2478064	Cabot Microelectronics Corporation	13/09/2010	2478064	10817695.9	
2480247	Shire Orphan Therapies GmbH	23/09/2010	2480247	10819424.2	
2481225	Intel Corporation	25/08/2010	2481225	10819212.1	
2482486	Fujitsu Limited	16/01/2012	2482486	12151213.1	
2483655	Franz Haimer Maschinenbau KG	04/10/2010	2483655	10766252.0	German
2483754	Siemens Aktiengesellschaft	29/09/2010	2483754	10763659.9	German
2484102	British Telecommunications public limited company	09/09/2010	2484102	10757247.1	
2484127	Nokia Technologies Oy	15/09/2010	2484127	10819956.3	
2485091	Toray Industries, Inc.	16/09/2010	2485091	10820367.0	
2485144	Samsung Electronics Co., Ltd.	28/12/2011	2485144	11195940.9	
2485278	Kyocera Corporation	29/09/2010	2485278	10820604.6	
2486339	Hunter Douglas Inc.	04/10/2010	2486339	10822466.8	
2486551	Giesecke+Devrient Mobile Security GmbH	04/10/2010	2486551	10763625.0	German
2490720	Amgen British Columbia Millennium Pharmaceuticals, Inc.	22/10/2010	2490720	10825726.2	
2490989	Nederlandse organisatie voor wetenschappelijk onderzoek (NWO)	25/10/2010	2490989	10770640.0	
2495410	TOYOTA JIDOSHA KABUSHIKI KAISHA	20/12/2010	2495410	10849615.9	
2496031	China Academy of Telecommunications Technology	28/10/2010	2496031	10825944.1	
2496328	Chem Group, Inc.	02/11/2010	2496328	10827656.9	
2497182	Atlas Copco Airpower, Naamloze Vennootschap	02/11/2010	2497182	10807315.6	
2498383	Yazaki Corporation	05/11/2010	2498383	10828365.6	
2498877	Fisher Controls International LLC	22/10/2010	2498877	10771864.5	
2501303	Zimmer Knee Creations, Inc.	19/11/2010	2501303	10832293.4	
2501306	Zimmer Knee Creations, Inc.	19/11/2010	2501306	10832285.0	
2501544	The LYCRA Company UK Limited	05/11/2010	2501544	10830544.2	
2502296	Forschungszentrum Jülich GmbH	17/11/2010	2502296	10784263.5	German
2505262	Solvay Special Chem Japan, Ltd.	25/11/2010	2505262	10833262.8	
2505263	Solvay Special Chem Japan, Ltd.	25/11/2010	2505263	10833263.6	
2506002	NGK Insulators, Ltd.	05/03/2012	2506002	12158098.9	
2508815	TROX GmbH	08/04/2011	2508815	11161712.2	German

2509593	PharmaEssentia Corporation	09/12/2010	2509593	10836693.1	
2512599	Theraclion SA	07/12/2010	2512599	10787758.1	
2512918	Airbus Operations Ltd. Compagnie Générale des Etablissements Michelin	17/12/2010	2512918	10807612.6	French
2514110	Nokia Solutions and Networks Oy	17/12/2009	2514110	09852184.2	
2514166	Orange	13/12/2010	2514166	10805474.3	French
2514364	Canon Kabushiki Kaisha	17/12/2009	2514364	09852294.9	
2514879	Doosan Infracore Co., Ltd.	05/11/2010	2514879	10837780.5	
2515057	Messer Group GmbH	02/04/2012	2515057	12162842.4	German
2515686	Südzucker Aktiengesellschaft Mannheim/Ochsenfurt	22/12/2010	2515686	10805776.1	
2515942	Pfizer Inc.	15/12/2010	2515942	10842554.7	
2516537	Compagnie Générale des Etablissements Michelin	15/12/2010	2516537	10796010.6	French
2516663	Danisco US Inc.	17/12/2010	2516663	10813055.0	
2516759	Fluor Technologies Corporation	17/12/2010	2516759	10838282.1	
2517382	Alcatel Lucent	22/12/2010	2517382	10840096.1	
2517517	Intel Corporation	04/11/2010	2517517	10842410.2	
2518484	MERCK LTD. Toppan Printing Co., Ltd.	21/12/2010	2518484	10839389.3	
2519781	BSH Hausgeräte GmbH	10/12/2010	2519781	10795995.9	German
2521802	Praxair S.T. Technology, Inc.	13/07/2010	2521802	10737409.2	
2522114	Cisco Technology, Inc.	30/12/2010	2522114	10801288.1	
2522978	AVL List GmbH	05/04/2012	2522978	12163277.2	German
2525773	Mycone Dental Supply Co. Inc.	13/04/2011	2525773	11769500.7	
2526989	Boehringer Ingelheim International GmbH	23/05/2011	2526989	11004238.9	
2530995	ZTE Corporation	21/09/2010	2530995	10855797.6	
2537619	General Electric Company	15/06/2012	2537619	12172275.5	
2539031	Aquamill Five Star Pty Ltd	23/02/2011	2539031	11746749.8	
2539369	Rinat Neuroscience Corp.	24/02/2011	2539369	11711673.1	
2540864	Rolls-Royce plc	15/06/2012	2540864	12172204.5	
2541712	Nexans	18/06/2012	2541712	12172422.3	French
2542567	BOEHRINGER INGELHEIM INTERNATIONAL GMBH	02/03/2011	2542567	11707643.0	German
2543093	De Kegel, Jacques Philemon Antoine	02/03/2011	2543093	11711003.1	

2543119	The Regents of the University of California	04/03/2011	2543119	11751456.2	
2543593	Compagnie Générale des Etablissements Michelin Airbus Operations Limited	17/12/2010	2543593	12185386.5	French
2543701	Evonik Operations GmbH	22/06/2012	2543701	12173170.7	German
2544305	Furuno Electric Company Limited	02/07/2012	2544305	12174630.9	
2545360	3M Innovative Properties Company	04/03/2011	2545360	11709544.8	
2546189	Commissariat à l'Énergie Atomique et aux Énergies Alternatives NXP USA, Inc.	10/07/2012	2546189	12175740.5	French
2547018	LG Electronics Inc.	11/03/2011	2547018	11753642.5	
2547388	CareFusion 207, Inc.	15/03/2011	2547388	11756831.1	
2547627	Envitech Engineering (Environmental Technology Engineering) Sàrl	15/03/2011	2547627	11717020.9	
2547983	Hologic, Inc.	18/03/2011	2547983	11757051.5	
2548119	Alcatel Lucent	01/03/2011	2548119	11717329.4	
2548124	Advanced Micro Devices, Inc.	16/03/2011	2548124	11712094.9	
2548207	Rapiscan Systems, Inc.	14/03/2011	2548207	11756812.1	
2548910	Nippon Shokubai Co., Ltd.	17/03/2011	2548910	11756400.5	
2549734	Hewlett-Packard Development Company, L.P.	29/03/2012	2549734	12162178.3	
2550607	Reversinglabs Corporation	23/03/2011	2550607	11714614.2	
2551960	Kuang-Chi Innovative Technology Ltd. Kuang-Chi Institute of Advanced Technology	27/10/2011	2551960	11860701.9	
2554446	Bosch Corporation	11/03/2011	2554446	11765314.7	
2554468	Shimano, Inc.	21/12/2011	2554468	11194722.2	
2557099	DIC Corporation	19/07/2011	2557099	11814446.8	
2557407	Fenwal, Inc.	08/08/2012	2557407	12179708.8	
2560759	QIAGEN GmbH	19/04/2011	2560759	11771397.4	
2561045	Honeywell International Inc.	05/04/2011	2561045	11772417.9	
2561172	Schlumberger Technology B.V.	24/05/2011	2561172	11786216.9	
2561824	Chiquillo Perez, Luis Mauricio	03/03/2010	2561824	10846926.3	
2562885	ROBERT BOSCH GMBH	10/07/2012	2562885	12175655.5	German
2564236	VAISALA OYJ	28/04/2011	2564236	11774484.7	
2564266	View, Inc.	25/04/2011	2564266	11775488.7	

2564344	Nokia Technologies Oy	18/04/2011	2564344	11774472.2	
2565171	Fujikura, Ltd.	02/06/2011	2565171	11789890.8	
2566116	Samsung Electronics Co., Ltd.	27/04/2011	2566116	11775260.0	
2567570	Nokia Technologies Oy	02/05/2011	2567570	11780262.9	
2568913	Intuitive Surgical Operations, Inc.	04/05/2011	2568913	11719951.3	
2569498	Huf Hülsbeck & Fürst GmbH & Co. KG	10/05/2011	2569498	11719537.0	German
2570082	Samsung Medison Co., Ltd.	10/09/2012	2570082	12183676.1	
2571419	Zoll Medical Corporation	17/05/2011	2571419	11784088.4	
2574726	General Electric Company	17/09/2012	2574726	12184622.4	
2574899	SYSMEX CORPORATION	28/09/2012	2574899	12186556.2	
2576173	Faurecia Innenraum Systeme GmbH	19/05/2011	2576173	11722742.1	German
2576602	Spixia Biotechnology AB	27/05/2011	2576602	11722068.1	
2577271	University Court of The University of St Andrews	02/06/2011	2577271	11730041.8	
2577889	LG Electronics Inc.	01/04/2011	2577889	11792604.8	
2579070	Kimoto Co., Ltd.	26/05/2011	2579070	11789684.5	
2579109	Seiko Epson Corporation	20/09/2012	2579109	12185196.8	
2579335	The Boeing Company	02/10/2012	2579335	12186945.7	
2579821	Smith & Nephew, Inc.	08/06/2011	2579821	11793109.7	
2580313	UCL Business PLC	02/06/2011	2580313	11731030.0	
2580714	Touchcode Technologies, LLC	10/06/2011	2580714	11734028.1	German
2582557	Corfitsen, Sten	17/06/2011	2582557	11798455.9	
2583254	Qualcomm Incorporated	17/06/2011	2583254	11727622.0	
2583433	Microsoft Technology Licensing, LLC	25/05/2011	2583433	11796141.7	
2583605	Samsung Electronics Co., Ltd.	18/10/2012	2583605	12188917.4	
2584663	FRAM Group IP LLC	18/10/2012	2584663	12188970.3	
2584687	Hewlett-Packard Development Company, L.P.	18/10/2012	2584687	12189116.2	
2584816	Qualcomm Incorporated	09/03/2006	2584816	13150106.6	
2586738	NCR Corporation	29/08/2012	2586738	12182216.7	
2587143	Mitsubishi Heavy Industries, Ltd.	13/06/2011	2587143	11798003.7	
2587307	LG Innotek Co., Ltd.	17/08/2012	2587307	12180797.8	
2587640	Mitsubishi Electric Corporation	28/06/2010	2587640	10854054.3	
2589111	Timsit, Roland S.	27/06/2011	2589111	11800010.8	
2589896	LG Electronics Inc.	27/03/2012	2589896	12161518.1	
2589947	The Boeing Company	15/10/2012	2589947	12188540.4	

2590306	Mitsubishi Electric Corporation	04/11/2010	2590306	10854125.1	
2590364	ZTE Corporation	09/05/2011	2590364	11814046.6	
2590444	Alcatel Lucent	04/11/2011	2590444	11290513.8	
2590796	Colormatrix Holdings, Inc.	05/07/2011	2590796	11751640.1	
2591209	Edwards Limited	19/05/2011	2591209	11721820.6	
2592495	Hewlett-Packard Development Company, L.P.	25/09/2012	2592495	12185918.5	
2592813	BlackBerry Limited	09/05/2012	2592813	12167281.0	
2593067	Permobil AB	08/07/2011	2593067	11807151.3	
2593298	Acell Industries Limited	15/12/2010	2593298	10801684.1	
2593711	Ledlenser GmbH & Co. KG	12/07/2011	2593711	11809298.0	German
2601567	Apple Inc.	05/08/2011	2601567	11745874.5	
2602573	Daikin Industries, Ltd.	21/07/2011	2602573	11814459.1	
2604167	BSH Hausgeräte GmbH	03/12/2012	2604167	12195220.4	German
2604510	The Boeing Company	13/12/2012	2604510	12196943.0	
2604512	Airbus Operations Limited	04/12/2012	2604512	12195396.2	
2605420	THALES	14/12/2012	2605420	12197331.7	French
2607140	Volkswagen Aktiengesellschaft	14/12/2012	2607140	12197110.5	German
2607942	LG Chem, Ltd.	19/08/2011	2607942	11818432.4	
2609296	Safran Helicopter Engines	23/08/2011	2609296	11761656.5	French
2609682	Micro Motion, Inc.	27/08/2010	2609682	10763074.1	
2610593	Robert Bosch GmbH	29/12/2011	2610593	11010266.2	
2610679	Hewlett-Packard Development Company, L.P.	18/09/2012	2610679	12184908.7	
2613022	General Electric Company	20/12/2012	2613022	12198384.5	
2613716	Aesculap AG	30/08/2011	2613716	11749417.9	German
2613851	VID Fire-Kill ApS	31/08/2011	2613851	11752096.5	
2614192	Rockwool International A/S	18/08/2011	2614192	11746486.7	
2616800	Fresenius Medical Care Holdings, Inc.	13/09/2011	2616800	11764021.9	
2616907	Kopin Corporation	19/09/2011	2616907	11827303.6	
2617484	Kanagawa University	31/08/2011	2617484	11824984.6	
2617560	Solarpack Trading B.V.	09/09/2011	2617560	11776534.7	
2617772	Mitsubishi Engineering-Plastics Corporation	31/08/2011	2617772	11824982.0	
2617970	TOYOTA JIDOSHA KABUSHIKI KAISHA	13/09/2010	2617970	10857235.5	
2620060	Asahi Group Holdings, Ltd.	06/09/2011	2620060	11826721.0	

2621462	The Procter & Gamble Company	29/09/2011	2621462	11770264.7	
2621927	BASF SE	27/09/2011	2621927	11761589.8	
2622430	Qualcomm Incorporated	27/09/2011	2622430	11767123.0	
2623352	NISSAN MOTOR CO., LTD.	27/07/2011	2623352	11828605.3	
2623461	Dowa Holdings Co., Ltd.	21/09/2011	2623461	11828878.6	
2623961	Terumo Kabushiki Kaisha	19/07/2011	2623961	11828584.0	
2625477	va-Q-tec AG	20/09/2011	2625477	11757654.6	German
2625722	Applied Materials, Inc.	26/08/2011	2625722	11831127.3	
2626118	Sony Interactive Entertainment Europe Limited	10/12/2012	2626118	12196280.7	
2626568	Edwards Japan Limited	28/07/2011	2626568	11830428.6	
2627115	China Academy of Telecommunications Technology	12/08/2011	2627115	11816124.9	
2627775	Compagnie Industrielle De La Matiere Vegetale CIMV	05/10/2011	2627775	11764221.5	
2628333	Nokia Technologies Oy	13/10/2010	2628333	10858359.2	
2628464	Edwards Lifesciences Corporation	15/12/2008	2628464	13002630.5	
2628569	ROBERT BOSCH GMBH	17/12/2009	2628569	13167489.7	German
2630472	Johnson Matthey Public Limited Company	21/10/2011	2630472	11778662.4	
2632376	Medtronic Ardian Luxembourg S.à.r.l.	25/10/2011	2632376	11779061.8	
2633286	Fraunhofer-Gesellschaft zur Förderung der angewandten Forschung e.V.	25/10/2011	2633286	11785330.9	German
2633627	Samsung Electronics Co., Ltd.	28/10/2011	2633627	11836665.7	
2634092	Hamilton Sundstrand Corporation	28/02/2013	2634092	13157154.9	
2634222	Kaneka Corporation	24/10/2011	2634222	11836225.0	
2635452	Belron International Limited	02/11/2011	2635452	11781584.5	
2635816	Transvac Systems Limited	07/11/2011	2635816	11782465.6	
2636173	Qualcomm Incorporated	04/11/2011	2636173	11788652.3	
2639643	Ricoh Company, Ltd.	28/02/2013	2639643	13157210.9	
2641850	MBDA France	18/03/2013	2641850	13290067.1	French
2642374	Wacom Co., Ltd.	05/03/2013	2642374	13157751.2	
2645991	GreenMark Biomedical Inc.	02/12/2011	2645991	11845209.3	
2646805	Comvita New Zealand Limited	29/11/2011	2646805	11845100.4	
2646990	VERIMATRIX	17/11/2011	2646990	11796755.4	French
2648163	Tata Consultancy Services Limited	28/08/2012	2648163	12182057.5	
2650919	HiDeep Inc.	28/03/2013	2650919	13161524.7	

2651848	Chryso	15/12/2011	2651848	11794521.2	French
2652398	BSH Hausgeräte GmbH	07/12/2011	2652398	11794700.2	German
2654929	Johnson Matthey Public Limited Company	21/12/2011	2654929	11805159.8	
2654943	Kimberly-Clark Worldwide, Inc.	16/11/2011	2654943	11851701.0	
2655456	TOTAL MARKETING SERVICES	21/12/2011	2655456	11810689.7	French
2656347	Intel Corporation	16/12/2011	2656347	11851426.4	
2657524	Samsung Electronics Co., Ltd.	18/04/2013	2657524	13164316.5	
2657677	Casa Maristas Azterlan	23/04/2012	2657677	12382155.5	
2657875	NEC Corporation	20/12/2011	2657875	11850050.3	
2657888	Hitachi-Omron Terminal Solutions, Corp.	22/12/2010	2657888	10860934.8	
2658439	DIA IMAGING ANALYSIS LTD.	29/12/2011	2658439	11852693.8	
2658643	Rohm and Haas Company	07/12/2011	2658643	11802242.5	
2658920	Dow Global Technologies LLC	29/12/2011	2658920	11811292.9	
2662021	Toshiba Medical Systems Corporation	09/12/2011	2662021	11847882.5	
2664131	Samsung Electronics Co., Ltd.	29/02/2012	2664131	12774170.0	
2664340	DUKE UNIVERSITY	21/06/2006	2664340	13176325.2	
2664453	Ottobock SE & Co. KGaA	11/04/2013	2664453	13001894.8	German
2664940	Alps Alpine Co., Ltd.	28/12/2011	2664940	11855718.0	
2665131	OMRON CORPORATION	10/05/2013	2665131	13167298.2	
2665319	Alcatel Lucent	14/05/2012	2665319	12360038.9	
2665691	Canon Kabushiki Kaisha	09/12/2011	2665691	11856436.8	
2666273	Airbus DS SAS	21/10/2011	2666273	11781767.6	
2667900	Shaver, William A.	13/12/2011	2667900	11810932.1	
2668463	General Dynamics Ordnance and Tactical Systems - Canada Inc.	04/05/2011	2668463	11857367.4	
2669583	ELECTROLUX PROFESSIONAL S.p.A.	29/05/2012	2669583	12169715.5	
2671805	CT Ingenierie	07/06/2013	2671805	13171081.6	French
2674074	Intex Marketing Ltd.	12/06/2012	2674074	13001948.2	
2674096	Karl Storz SE & Co. KG	31/05/2013	2674096	13002818.6	German
2675064	École Polytechnique Centre National de la Recherche Scientifique	15/06/2012	2675064	12305684.8	
2675423	BASF Corporation	14/02/2012	2675423	12747720.6	
2675860	Zephyros Inc.	15/02/2012	2675860	12707226.2	

2676784	Airbus Operations Limited	14/06/2013	2676784	13171988.2	
2680492	Infinera Oy	14/06/2013	2680492	13171954.4	
2680702	The Gillette Company LLC	28/02/2012	2680702	12709210.4	
2681084	PVP Technologies Canada Inc.	01/03/2012	2681084	12712306.5	French
2681175	Corning Incorporated	20/02/2012	2681175	12708431.7	
2684058	Airbus Operations GmbH	29/02/2012	2684058	12709547.9	
2684292	PGS Geophysical AS	01/03/2012	2684292	12710885.0	
2684313	De Cuba, Riangelo, Javier	12/03/2012	2684313	12716608.0	
2684634	Cloos Innovations-GmbH	09/07/2012	2684634	12175565.6	German
2685589	Samsung SDI Co., Ltd.	17/04/2013	2685589	13164060.9	
2686031	ConvaTec Technologies Inc.	16/03/2012	2686031	12833128.7	
2686812	Hörmann KG Antriebstechnik	16/03/2012	2686812	12715624.8	German
2686906	CommScope Technologies LLC	11/06/2012	2686906	12828814.9	
2687060	Qualcomm Incorporated	16/03/2012	2687060	12711311.6	
2687559	Kaneka Corporation	16/03/2012	2687559	12758140.3	
2688590	GlaxoSmithKline Biologicals SA	23/03/2012	2688590	12718460.4	
2690046	Murata Machinery, Ltd.	08/07/2013	2690046	13175516.7	
2690152	Nisshinbo Brake Inc.	14/03/2012	2690152	12761440.2	
2690187	Ferry Capitain	15/07/2013	2690187	13176453.2	French
2690544	Samsung Electronics Co., Ltd.	24/07/2013	2690544	13177845.8	
2693128	Lehtimäki, Pasi Tommola, Esa	01/08/2013	2693128	13396008.8	
2693366	Toyota Motor Engineering & Manufacturing North America, Inc.	02/08/2013	2693366	13179101.4	
2693417	Honeywell International Inc.	19/07/2013	2693417	13177270.9	
2693627	ABB Schweiz AG	24/07/2013	2693627	13177856.5	
2693791	LG Electronics Inc.	16/11/2011	2693791	11862080.6	
2693938	Flint Hills Scientific, LLC	03/03/2012	2693938	12722939.1	
2696486	Hamilton Sundstrand Corporation	02/08/2013	2696486	13179054.5	
2697534	Gulfstream Aerospace Corporation	11/04/2012	2697534	12771281.8	
2698312	Kite Power Systems Limited	15/08/2012	2698312	12180579.0	
2699288	Sanofi-Aventis Deutschland GmbH	19/04/2012	2699288	12714719.7	
2699840	Cree, Inc.	10/04/2012	2699840	12720716.5	
2700869	Koito Manufacturing Co., Ltd.	04/04/2012	2700869	12774115.5	
2701178	ASML Netherlands B.V.	30/10/2003	2701178	13179104.8	
2702271	Waters Technologies Corporation	17/04/2012	2702271	12777825.6	
2702346	Xylem IP Holdings LLC	25/04/2012	2702346	12719863.8	

2702438	L.E.S.S. LTD	28/03/2012	2702438	12720570.6	
2702767	Koninklijke Philips N.V.	23/04/2012	2702767	12720649.8	
2702874	Mars, Incorporated	13/02/2006	2702874	13192351.8	
2703035	Sayco Pty. Ltd.	23/08/2013	2703035	13181555.7	
2703584	ASSA ABLOY Sicherheitstechnik GmbH	04/09/2013	2703584	13183048.1	German
2703782	GE Aviation Systems LLC	27/08/2013	2703782	13181836.1	
2703919	Rolls-Royce plc	23/08/2013	2703919	13181458.4	
2703963	Nissha Printing Co., Ltd.	27/04/2012	2703963	12777100.4	
2704727	The Johns Hopkins University	24/04/2012	2704727	12786297.7	
2706397	Shenzhen China Star Optoelectronics Technology Co. Ltd.	19/05/2011	2706397	11865403.7	German
2706617	Schneider Electric Logistics Asia Pte Ltd.	03/09/2013	2706617	13182783.4	
2709276	Ricoh Company, Ltd.	10/09/2013	2709276	13183700.7	
2709871	Brusa Elektronik AG	27/04/2012	2709871	12722878.1	
2710360	Schott AG	11/05/2012	2710360	12720809.8	German
2710464	Apple Inc.	05/06/2012	2710464	12727050.2	
2711653	Nissan Motor Co., Ltd.	17/05/2012	2711653	12786643.2	
2712343	HP Scitex Ltd	05/07/2011	2712343	11869013.0	
2715147	Ingersoll-Rand Company	02/03/2012	2715147	12710014.7	
2716480	Mitsubishi Electric Corporation	01/06/2011	2716480	11866826.8	
2716585	Zimmer, Günther Stephan Zimmer, Martin Johannes	08/10/2013	2716585	13004827.5	German
2717569	Deutsche Telekom AG	01/10/2013	2717569	13186818.4	German
2718514	Albertelli, Aldino Friehe, Michael Albini, Marco Zedda, Roberto	01/06/2012	2718514	12727402.5	
2718901	Media Relief	08/06/2012	2718901	12731551.3	French
2719897	Mitsubishi Heavy Industries, Ltd.	17/05/2012	2719897	12797222.2	
2720365	Fuji Electric Co., Ltd.	20/08/2013	2720365	13180994.9	
2720680	Berg LLC	18/06/2012	2720680	12728936.1	
2722633	PLASAN SASA LTD.	17/10/2013	2722633	13189035.2	
2723683	UCL BUSINESS LTD	26/06/2012	2723683	12733182.5	
2724092	Arçelik Anonim Sirketi	27/06/2012	2724092	12732619.7	
2724135	Massachusetts Institute of Technology	30/05/2012	2724135	12804674.5	

2724362	LG Innotek Co., Ltd.	13/06/2012	2724362	12802555.8	
2724802	General Electric Company	14/10/2013	2724802	13188540.2	
2725936	Simon Fraser University	29/06/2012	2725936	12805056.4	
2726918	Vitro, S.A.B. de C.V.	18/04/2012	2726918	12722219.8	
2727435	Intel Corporation	27/03/2012	2727435	12807951.4	
2727553	ORMCO CORPORATION	28/10/2013	2727553	13190533.3	
2728489	Microsoft Technology Licensing, LLC	29/07/2004	2728489	14000362.5	
2728546	Ricoh Company, Ltd.	14/11/2012	2728546	12192685.1	
2728588	3M Innovative Properties Company	17/06/2010	2728588	14153148.3	
2728702	Delta Electronics (Thailand) Public Co., Ltd.	10/04/2013	2728702	13163025.3	
2730474	Hamilton Sundstrand Corporation	11/11/2013	2730474	13192282.5	
2730845	Mitsubishi Hitachi Power Systems, Ltd.	28/06/2012	2730845	12807850.8	
2731005	Samsung Electronics Co., Ltd.	12/11/2013	2731005	13192543.0	
2731260	NISSAN MOTOR CO., LTD.	04/07/2012	2731260	12808230.2	
2731986	Saint-Gobain Isover	12/07/2012	2731986	12744092.3	French
2732728	Taiwan Paiho Limited	08/03/2013	2732728	13158276.9	
2733548	Canon Kabushiki Kaisha	13/07/2012	2733548	12814269.2	
2733601	Brother Kogyo Kabushiki Kaisha	19/11/2013	2733601	13193544.7	
2733981	LG Electronics Inc.	13/07/2012	2733981	12810805.7	
2735859	SYSMEX CORPORATION	20/11/2013	2735859	13193634.6	
2737227	Saint Jean Industries	20/07/2012	2737227	12750431.4	French
2738586	Nanchang O-FILM Optical-Electronic Tech Co., LTD.	24/07/2012	2738586	12817490.1	
2738810	Sony Corporation	11/07/2012	2738810	12817111.3	
2739105	Alcatel Lucent	30/11/2012	2739105	12306497.4	
2739429	Foro Energy Inc.	02/08/2012	2739429	12820743.8	
2739858	Gebr. Becker GmbH	11/07/2012	2739858	12733507.3	German
2740048	Cisco Technology, Inc.	20/07/2012	2740048	12820481.5	
2741079	Osaka University	02/08/2012	2741079	12822219.7	
2741258	Kyocera Document Solutions Inc.	29/11/2013	2741258	13195041.2	
2741843	TSI, Incorporated	08/08/2012	2741843	12822091.0	
2741961	Discma AG	02/08/2012	2741961	12743162.5	
2742793	CLAAS Saulgau GmbH	18/09/2013	2742793	13184943.2	German
2743809	BlackBerry Limited	13/12/2012	2743809	12197083.4	
2744003	NXP USA, Inc.	09/12/2013	2744003	13196263.1	
2744159	NEC Corporation	10/08/2012	2744159	12822292.4	

2745156	Teledyne Instruments, Inc.	16/08/2012	2745156	12751235.8	
2745173	Canon Kabushiki Kaisha	11/07/2012	2745173	12824329.2	
2745784	Covidien LP	18/12/2013	2745784	13197958.5	
2745804	Cook Medical Technologies LLC	16/12/2013	2745804	13197500.5	
2746121	Nissan Motor Manufacturing (UK) Ltd.	17/12/2013	2746121	13197721.7	
2746237	HeidelbergCement AG	19/12/2012	2746237	12008433.0	German
2746593	FESTO AG & Co. KG	18/12/2012	2746593	12008397.7	German
2746704	BSH Hausgeräte GmbH	12/12/2013	2746704	13196786.1	German
2747261	Hitachi, Ltd. Hitachi Mito Engineering Co., Ltd.	09/12/2013	2747261	13196329.0	
2747277	Sagemcom Energy & Telecom SAS	15/11/2013	2747277	13193127.1	French
2747551	Yecuris Corporation	24/08/2012	2747551	12828793.5	
2750024	Brother Kogyo Kabushiki Kaisha	31/12/2013	2750024	13199911.2	
2750064	Dassault Systèmes	20/12/2013	2750064	13199183.8	
2750316	Avago Technologies International Sales Pte. Limited	30/12/2013	2750316	13006060.1	
2750592	Zoll Medical Corporation	15/08/2012	2750592	12827824.9	
2751172	Performance Materials NA, Inc.	31/08/2012	2751172	12762461.7	
2751603	Skorpios Technologies, Inc.	29/08/2012	2751603	12827040.2	
2752488	Roche Innovation Center Copenhagen A/S	18/11/2003	2752488	14163184.6	
2754984	IHI Corporation	29/08/2012	2754984	12829418.8	
2755008	EXFO Inc.	18/12/2013	2755008	13197920.5	
2755984	Agilent Technologies, Inc.	13/09/2012	2755984	12761867.6	
2756607	Samsung Electronics Co., Ltd.	13/09/2012	2756607	12832393.8	
2758329	LEMO Maschinenbau GmbH	18/09/2012	2758329	12762263.7	German
2758597	Kimberly-Clark Worldwide, Inc.	09/08/2012	2758597	12832810.1	
2758897	Qualcomm Incorporated	24/09/2012	2758897	12784364.7	
2759587	Baker Hughes, a GE company, LLC	06/03/2008	2759587	14164453.4	
2759809	Krohne AG	03/01/2014	2759809	14000008.4	German
2760582	Biocartis NV	27/09/2012	2760582	12762637.2	
2761289	Somalologic, Inc.	28/09/2012	2761289	12836076.5	
2761353	LG Innotek Co., Ltd.	25/09/2012	2761353	12835064.2	
2762275	Schmitz, Michael	09/01/2014	2762275	14150525.5	German
2762686	NISSAN MOTOR CO., LTD. Sanden Holdings Corporation	06/08/2012	2762686	12837266.1	
2763817	Wera Werkzeuge GmbH	02/10/2012	2763817	12770109.2	German

2765046	TOYOTA JIDOSHA KABUSHIKI KAISHA	03/10/2011	2765046	11873564.6	
2765816	Sun Patent Trust	19/09/2012	2765816	12838410.4	
2767781	THE HYMATIC ENGINEERING COMPANY LIMITED	16/12/2013	2767781	13275318.7	
2768680	Birdseye, Nicholas	16/10/2012	2768680	12842223.5	
2770409	TPK Touch Solutions Inc.	18/02/2014	2770409	14155577.1	
2770529	Kabushiki Kaisha Toshiba	09/09/2013	2770529	13183600.9	
2770942	Kulzer GmbH	27/09/2012	2770942	12766595.8	German
2772301	Mehldau & Steinfath Umwelttechnik GmbH	02/12/2011	2772301	14152889.3	
2772792	Johnson & Johnson Vision Care, Inc.	28/02/2014	2772792	14157336.0	
2773905	Whirlpool EMEA S.p.A.	02/11/2012	2773905	12799621.3	
2773950	Johnson Matthey Public Limited Company	02/11/2012	2773950	12788244.7	
2774012	Raytheon Company	31/08/2012	2774012	12845012.9	
2774019	Nokia Technologies Oy	31/10/2012	2774019	12845852.8	
2774044	Akamai Technologies, Inc.	01/11/2012	2774044	12844987.3	
2775376	Apple Inc.	16/07/2009	2775376	14171398.2	
2775601	Dialog Semiconductor GmbH	04/03/2013	2775601	13368006.6	
2775608	General Electric Company	21/02/2014	2775608	14156193.6	
2775918	Abbott Diabetes Care Inc.	07/11/2012	2775918	12847803.9	
2777918	Automobili Lamborghini S.P.A.	14/06/2011	2777918	14171906.2	
2779137	Siemens Mobility GmbH	26/02/2014	2779137	14156691.9	German
2779685	Sony Corporation	02/11/2012	2779685	12847156.2	
2780287	Tronox LLC	15/11/2012	2780287	12849827.6	
2780665	Safran Aircraft Engines	12/11/2012	2780665	12795517.7	French
2782506	Cook Medical Technologies LLC	21/11/2012	2782506	12798986.1	
2783050	Saipem S.p.A.	23/11/2012	2783050	12815788.0	
2783599	DIY Element System GmbH	25/03/2014	2783599	14161615.1	German
2783890	Toyota Jidosha Kabushiki Kaisha	22/11/2011	2783890	11876115.4	
2786021	WILO SE	23/11/2012	2786021	12818777.0	German
2786419	Konica Minolta Laboratory U.S.A., Inc.	29/11/2012	2786419	12853216.5	
2786963	Shin-Etsu Chemical Co., Ltd.	29/11/2012	2786963	12852947.6	
2787368	Maxell, Ltd.	02/04/2014	2787368	14163155.6	
2787799	Fujikura Ltd.	14/11/2012	2787799	12854222.2	
2789207	NEC Corporation	15/11/2012	2789207	12799333.5	

2789604	Anhui Biochem Bio-Pharmaceutical Co. Ltd.	28/11/2012	2789604	12855855.8	
2792573	Hitachi, Ltd.	26/03/2014	2792573	14161797.7	
2795028	Dr. Hahn GmbH & Co. KG	11/12/2012	2795028	12816466.2	German
2795190	General Electric Technology GmbH	30/11/2012	2795190	12813504.3	
2796696	Toyota Jidosha Kabushiki Kaisha	21/12/2011	2796696	11878198.8	
2797456	Schawbel Technologies LLC	27/12/2012	2797456	12821352.7	
2797499	Canon Kabushiki Kaisha	14/12/2012	2797499	12820945.9	
2797771	Vestas Wind Systems A/S	20/12/2012	2797771	12810056.7	
2798094	POSCO	27/12/2012	2798094	12862705.6	
2798221	Nuovo Pignone S.p.A.	17/12/2012	2798221	12801739.9	
2798373	Koninklijke Philips N.V.	17/12/2012	2798373	12821309.7	
2799173	Ledermann GmbH & Co. KG	04/05/2013	2799173	13002391.4	German
2799883	Hitachi High-Technologies Corporation	18/12/2012	2799883	12861140.7	
2800745	Phenex Pharmaceuticals AG	03/12/2012	2800745	12795742.1	
2800947	Rafael Advanced Defense Systems Ltd.	27/12/2012	2800947	12864658.5	
2801725	PFEIFFER VACUUM GMBH	04/04/2014	2801725	14163489.9	German
2802011	LG Innotek Co., Ltd.	31/03/2014	2802011	14162537.6	
2802112	Sandvine Incorporated ULC	08/05/2013	2802112	13166992.1	
2802398	Davco Technology, L.L.C.	20/12/2012	2802398	12813664.5	
2802956	BSH Hausgeräte GmbH	21/12/2012	2802956	12812644.8	German
2803184	OmniVision Technologies, Inc.	28/12/2012	2803184	12864741.9	
2803815	SCHLUMBERGER TECHNOLOGY B.V.	16/05/2013	2803815	13305629.1	
2807795	Microsoft Technology Licensing, LLC	08/03/2013	2807795	13767690.4	
2808102	Bora Poland Sp. z o.o.	30/05/2013	2808102	13169938.1	
2808136	Weber Maschinenbau GmbH Breidenbach	24/04/2014	2808136	14165790.8	German
2808320	Kyocera Document Solutions Inc.	26/05/2014	2808320	14169811.8	
2809338	The Regents of the University of California	26/10/2012	2809338	12842939.6	
2810701	IN - EKO Team s.r.o.	22/05/2014	2810701	14169431.5	
2813152	Tobacco Research And Development Institute (Proprietary) Limited	01/06/2012	2813152	14180649.7	
2813178	Kyushu Institute of Technology	19/12/2012	2813178	12868191.3	
2813909	Honeywell International Inc.	30/05/2014	2813909	14170706.7	

2815696	Shimazaki, Takunori Soliton Systems K.K.	16/06/2014	2815696	14172536.6	
2817926	Huawei Technologies Co., Ltd.	22/02/2013	2817926	13708320.0	
2818215	SmileGate Entertainment, Inc.	10/04/2014	2818215	14164275.1	
2819309	Rohde & Schwarz GmbH & Co. KG	16/05/2014	2819309	14168646.9	German
2819591	Synthes GmbH	27/02/2013	2819591	13710185.3	
2821557	Grohe AG	01/07/2014	2821557	14002256.7	German
2822267	Samsung Electronics Co., Ltd.	10/03/2014	2822267	14158591.9	
2824157	Institute of Systems, Information Technologies and Nanotechnologies Kyushu University Nissan Chemical Corporation	08/03/2013	2824157	13757549.4	
2825058	N.V. Nutricia	12/03/2012	2825058	12710375.2	
2825479	Alydia Health, Inc.	14/03/2013	2825479	13761088.7	
2826241	Covidien LP	15/02/2013	2826241	13749101.5	
2826432	Synthes GmbH	04/05/2011	2826432	14003456.2	
2826918	Daikin Industries, Ltd.	14/03/2013	2826918	13761072.1	
2827251	NEC Corporation	08/03/2013	2827251	13761770.0	
2827316	Harman Becker Automotive Systems GmbH	15/07/2013	2827316	13176508.3	
2827481	The Boeing Company	16/07/2014	2827481	14177338.2	
2828979	Cisco Technology, Inc.	22/03/2013	2828979	13717365.4	
2830337	ZTE Corporation	06/05/2013	2830337	13787629.8	
2830528	Medtronic Navigation, Inc.	22/03/2013	2830528	13717997.4	
2830793	ArcelorMittal	28/03/2012	2830793	12719050.2	
2831666	Adlens Ltd	14/12/2012	2831666	12809724.3	
2831686	Emerson Process Management Regulator Technologies, Inc.	27/03/2013	2831686	13716613.8	
2833125	Ruprecht-Karls-Universität Heidelberg Carl Zeiss Microscopy GmbH	30/07/2014	2833125	14179050.1	German
2833826	Zeus Industrial Products, Inc.	18/03/2013	2833826	13772707.9	
2834476	Stamicarbon B.V. acting under the name of MT Innovation Center ENEA - Agenzia Nazionale Per Le Nuove Tecnologie, L'Energia e Lo Sviluppo Economico Sostenibile	19/03/2013	2834476	13712386.5	
2834638	Astute Medical, Inc.	02/04/2013	2834638	13772034.8	

2834942	Telefonaktiebolaget LM Ericsson (publ)	05/04/2012	2834942	12717071.0	
2835292	Toyota Jidosha Kabushiki Kaisha	02/04/2012	2835292	12873847.3	
2836827	Sony Corporation	05/03/2013	2836827	13711748.7	
2837524	Siemens Mobility S.A.S.	14/08/2013	2837524	13290191.9	French
2837657	Zeon Corporation	12/04/2012	2837657	12874328.3	
2837905	Alfa Laval Corporate AB	12/08/2013	2837905	13180151.6	
2838373	Intercontinental Great Brands LLC	15/03/2013	2838373	13713310.4	
2838728	Lamart Corporation Unifrax I LLC	13/03/2013	2838728	13717700.2	
2838860	SCHOTT AG	19/04/2013	2838860	13717776.2	German
2839699	Qualcomm Incorporated	15/03/2013	2839699	13714136.2	
2840000	AUDI AG	12/07/2014	2840000	14002408.4	German
2840405	Mitsubishi Electric Corporation	12/02/2013	2840405	13778064.9	
2840839	ZTE Corporation	05/06/2012	2840839	12874649.2	
2841482	Dow Global Technologies LLC	26/03/2013	2841482	13783120.2	
2842545	Osaka University	23/04/2013	2842545	13781750.8	
2844672	Regeneron Pharmaceuticals, Inc.	02/05/2013	2844672	13721544.8	
2845220	Silicon Genesis Corporation	03/05/2013	2845220	13784851.1	
2846416	TE Connectivity India Private Limited	22/08/2014	2846416	14181927.6	
2847539	Carl Zeiss Industrielle Messtechnik GmbH	07/05/2012	2847539	12719703.6	German
2849331	ABB Schweiz AG	11/09/2013	2849331	13183897.1	
2849434	Mission Infrared Electro Optics Technology Co. Ltd	23/05/2013	2849434	13794061.5	
2849555	Turnset AB	17/05/2013	2849555	13790233.4	
2850468	Landmark Graphics Corporation	13/03/2013	2850468	13791058.4	
2850641	Thermo Finnigan LLC	03/05/2013	2850641	13791430.5	
2850655	Safran Electronics & Defense	14/05/2013	2850655	13724222.8	French
2851109	AFC Air Filtration & Containment GmbH	31/07/2014	2851109	14179232.5	German
2852234	Sharp Kabushiki Kaisha	15/05/2013	2852234	13790091.6	
2853393	Seiko Epson Corporation	11/09/2014	2853393	14184460.5	
2854470	Institute for Information Industry	26/09/2014	2854470	14186553.5	
2854514	Agriculture Victoria Services Pty Ltd	29/05/2013	2854514	13796907.7	
2854776	University College Dublin National University Of Ireland, Dublin	31/05/2013	2854776	13726776.1	
2856457	Karsten Manufacturing Corporation	31/05/2013	2856457	13731546.1	

2856722	Safran Electronics & Defense	30/05/2013	2856722	13725977.6	French
2856753	Cisco Technology, Inc.	22/05/2013	2856753	13729834.5	
2856755	Beissbarth GmbH	14/05/2013	2856755	13725104.7	German
2857597	Hitachi Construction Machinery Co., Ltd.	28/03/2013	2857597	13798155.1	
2859020	Firestone Polymers, LLC	05/06/2013	2859020	13800495.7	
2861005	Nokia Solutions and Networks Oy	23/07/2014	2861005	14178103.9	
2861435	BASF SE	17/06/2013	2861435	13729353.6	German
2861533	BASF Corporation	13/06/2013	2861533	13805062.0	
2862273	Skyworks Solutions, Inc.	13/06/2013	2862273	13805010.9	
2862600	Oriflame Research and Development Ltd.	20/12/2011	2862600	14196664.8	
2863014	General Electric Company	08/10/2014	2863014	14188184.7	
2863571	LG Electronics Inc.	02/05/2013	2863571	13784987.3	
2864539	Koninklijke Philips N.V.	24/06/2013	2864539	13759582.3	
2864729	Autarkis B.V.	21/06/2013	2864729	13737449.2	
2864739	M & S Flowmatics Incorporated	21/06/2013	2864739	13807620.3	
2865125	Alshihi, Harib Darwish	21/06/2013	2865125	13806843.2	
2865215	Huawei Technologies Co., Ltd.	09/07/2013	2865215	13817213.5	
2866425	Tencent Technology (Shenzhen) Company Limited	06/06/2013	2866425	13807524.7	
2866564	Dow AgroSciences LLC	13/06/2013	2866564	13809642.5	
2867155	Rudenko, Pavlo	01/06/2013	2867155	13798053.8	
2867230	Monsanto Technology LLC	02/07/2013	2867230	13813965.4	
2867462	Halliburton Energy Services Inc.	02/07/2012	2867462	12880450.7	
2867484	Grannus, LLC	21/06/2013	2867484	13810420.3	
2867785	Intel Corporation	25/06/2013	2867785	13809278.8	
2868384	Mitsubishi Hitachi Power Systems Environmental Solutions, Ltd.	17/05/2013	2868384	13809555.9	
2868486	BÖWE SYSTEC GmbH	28/10/2014	2868486	14190687.5	German
2869886	A.V. Medical Technologies, Ltd.	08/07/2013	2869886	13763115.6	
2871943	Lifeline Scientific, Inc.	08/07/2013	2871943	13740118.8	
2872394	Loon LLC	24/06/2013	2872394	13816199.7	
2872885	Centers for Disease Control and Prevention	16/07/2013	2872885	13819718.1	
2872904	Nanowave Technologies Inc.	08/07/2013	2872904	13819817.1	

2873487	Tone Co., Ltd. Subaru Corporation	28/10/2014	2873487	14190734.5	
2874037	Introsys - Integration for Robotic Systems-Integração de Sistemas Robóticos, S.A.	11/07/2013	2874037	13752693.5	
2874575	Blatchford Products Limited	23/07/2013	2874575	13742699.5	
2874758	COROB S.P.A.	16/07/2013	2874758	13756669.1	
2874806	Ranpak Corp.	16/07/2013	2874806	13742348.9	
2875225	United Technologies Corporation	21/06/2013	2875225	13823850.6	
2877144	Unilever PLC	24/07/2013	2877144	13740022.2	
2877241	Cyberonics, Inc.	14/07/2013	2877241	13740179.0	
2878101	ITRON, INC.	15/05/2013	2878101	13823544.5	
2878885	General Electric Technology GmbH	28/10/2014	2878885	14190756.8	
2878942	APIX Analytics CALIFORNIA INSTITUTE OF TECHNOLOGY COMMISSARIAT À L'ÉNERGIE ATOMIQUE ET AUX ÉNERGIES ALTERNATIVES	02/12/2014	2878942	14195964.3	
2879136	Yazaki Corporation	24/07/2013	2879136	13822688.1	
2879899	WiTricity Corporation	22/07/2013	2879899	13747726.1	
2880550	F5 Networks, Inc	30/07/2013	2880550	13824898.4	
2881377	Messer Austria GmbH	18/11/2014	2881377	14193698.9	German
2881830	Sikorsky Aircraft Corporation	01/12/2014	2881830	14195618.5	
2882102	NXP B.V.	03/12/2014	2882102	14196140.9	
2882432	Dusa Pharmaceuticals, Inc.	09/08/2013	2882432	13827298.4	
2882519	ExxonMobil Research and Engineering Company	23/07/2013	2882519	13745287.6	
2882521	ExxonMobil Research and Engineering Company	23/07/2013	2882521	13745290.0	
2883776	ALSTOM Transport Technologies	28/11/2014	2883776	14195404.0	French
2884362	ROBERT BOSCH GMBH	13/12/2013	2884362	13197168.1	
2884587	Grupo General Cable Sistemas, S.A.	09/08/2012	2884587	12882817.5	
2884917	W. L. Gore & Associates, Inc.	05/08/2013	2884917	13750791.9	
2885468	Art Plastics Pty Ltd	14/08/2012	2885468	12882988.4	

2885633	CSEM Centre Suisse d'Electronique et de Microtechnique SA - Recherche et Développement	14/08/2013	2885633	13753129.9	
2885692	Synaptics Incorporated	07/06/2013	2885692	13829151.3	
2886918	Shanghai Hongyan Returnable Transit Packagings Co., Ltd.	16/08/2013	2886918	13829456.6	
2887308	QUALCOMM Incorporated	14/12/2004	2887308	15150847.0	
2887322	Microsoft Technology Licensing, LLC	18/12/2013	2887322	13198220.9	
2887635	CANON KABUSHIKI KAISHA	12/12/2014	2887635	14197732.2	
2887882	Children's Hospital Of Orange County	23/08/2013	2887882	13830984.4	
2888813	Carrier Corporation	14/08/2013	2888813	13752779.2	
2889046	International Paper Company	31/10/2014	2889046	14191365.7	
2889993	General Electric Company	09/12/2014	2889993	14197051.7	
2890076	China Academy of Telecommunications Technology	30/07/2013	2890076	13831399.4	
2890586	TOYOTA JIDOSHA KABUSHIKI KAISHA	29/11/2013	2890586	13821516.5	
2891316	LG ELECTRONICS INC.	28/08/2013	2891316	13832038.7	
2891520	Nippon Shokubai Co., Ltd.	30/08/2013	2891520	13832678.0	
2892154	NXP USA, Inc.	03/12/2014	2892154	14196150.8	
2892267	Tata Consultancy Services Limited	10/03/2014	2892267	14158516.6	
2892551	Orbis Health Solutions LLC	02/10/2013	2892551	13835508.6	
2893306	Johnson Matthey Public Limited Company	05/09/2013	2893306	13760093.8	
2893307	Johnson Matthey Public Limited Company	05/09/2013	2893307	13836229.8	
2894208	Nisshinbo Brake Inc.	28/06/2013	2894208	13797481.2	
2894579	Google LLC	13/08/2004	2894579	15151760.4	
2895210	W. L. Gore & Associates, Inc.	13/09/2013	2895210	13765925.6	
2895313	Finnah Packtec GmbH	13/09/2013	2895313	13774602.0	German
2895470	Symrise AG	14/09/2012	2895470	12758867.1	German
2895908	Carl Zeiss Microscopy GmbH	02/08/2013	2895908	13756334.2	German
2895968	Oracle International Corporation	12/09/2013	2895968	13766835.6	
2898482	Sensormatic Electronics LLC	10/09/2013	2898482	13765589.0	
2898879	Nitto Denko Corporation	20/09/2013	2898879	13840058.5	
2898998	Kawasaki Jukogyo Kabushiki Kaisha	06/09/2013	2898998	13835453.5	
2899491	MBDA France	07/01/2015	2899491	15290002.3	French

2900077	Nolivade	29/05/2013	2900077	13730003.4	French
2900535	Siemens Mobility GmbH	08/11/2013	2900535	13792293.6	German
2901326	Oracle International Corporation	27/09/2013	2901326	13777376.8	
2901968	Stryker Corporation	22/06/2012	2901968	15158097.4	
2904461	Emerson Process Management Regulator Technologies, Inc.	01/10/2013	2904461	13779664.5	
2905071	Nippon Shokubai Co., Ltd.	01/10/2013	2905071	13843510.2	
2907668	Seiko Epson Corporation	17/02/2015	2907668	15155472.2	
2908064	Blueair AB	18/02/2014	2908064	14155642.3	
2909783	McAfee, LLC	28/06/2013	2909783	13847351.7	
2909829	Manufacturing Resources International, INC.	16/10/2013	2909829	13846848.3	
2909924	Signify Holding B.V.	08/10/2013	2909924	13792756.2	
2909966	Cisco Technology, Inc.	15/10/2013	2909966	13785703.3	
2910236	Ivoclar Vivadent AG	24/02/2014	2910236	14156436.9	German
2910440	Goodrich Corporation	23/02/2015	2910440	15156051.3	
2911165	MURATA MANUFACTURING CO., LTD.	18/05/2012	2911165	15162012.7	
2911222	Toyota Jidosha Kabushiki Kaisha	23/02/2015	2911222	15156114.9	
2911435	Alcatel Lucent	24/02/2014	2911435	14305250.4	
2911507	Rhodia Operations	23/10/2013	2911507	13849920.7	
2911785	Sasol Technology (Proprietary) Limited	07/10/2013	2911785	13808225.0	
2912056	Statens Serum Institut	18/10/2013	2912056	13798236.9	
2912240	Eco Gutter IP Holdings Pty Ltd	26/10/2013	2912240	13849129.5	
2913000	C.R. BARD, INC.	27/05/2011	2913000	14197137.4	
2913148	Hexagon Metrology (Israel) Ltd. Cognitens Division	28/02/2014	2913148	14157229.7	
2913194	Fujitsu Component Limited	24/02/2015	2913194	15156423.4	
2913531	MITSUBISHI HEAVY INDUSTRIES, LTD.	16/02/2015	2913531	15155228.8	
2913675	GA Generic Assays GmbH	26/02/2015	2913675	15156756.7	
2913701	Fianium Limited	19/11/2008	2913701	14195882.7	
2914944	Inficon GmbH	04/11/2013	2914944	13786658.8	German
2915517	Kabushiki Kaisha Yaskawa Denki	26/02/2015	2915517	15156698.1	
2916511	Airbus Opérations SAS EADS Deutschland GmbH	07/03/2014	2916511	14158361.7	
2916574	Huawei Technologies Co., Ltd.	09/11/2012	2916574	12887889.9	

2916814	Colabs International Corporation Cohen, Laura E.	06/11/2013	2916814	13852949.0	
2916931	University Of South Florida	07/11/2013	2916931	13853845.9	
2917045	Maxion Wheels Germany Holding GmbH	04/11/2013	2917045	13795300.6	
2918382	Kai R & D Center Co., Ltd.	05/11/2013	2918382	13853144.7	
2919460	Zhejiang Dahua Technology Co., Ltd	23/05/2013	2919460	13854139.6	
2919565	Kitagawa Industries Co., Ltd.	29/10/2013	2919565	13852709.8	
2919840	Fisher & Paykel Healthcare Limited	14/11/2013	2919840	13854947.2	
2920069	Airbus Operations Limited Airbus Operations S.A.S.	15/11/2013	2920069	13792962.6	
2920159	Scientific Design Company Inc.	23/12/2013	2920159	13867735.6	
2920844	Huawei Technologies Co., Ltd.	18/12/2013	2920844	13868648.0	
2921120	Toyonaga, Takashi Olympus Corporation	12/11/2013	2921120	13855365.6	
2921150	Rebotec Rehabilitationsmittel GmbH	18/03/2014	2921150	14160524.6	German
2921630	ACO Severin Ahlmann GmbH & Co. KG	03/03/2015	2921630	15157334.2	German
2921950	Ricoh Company, Ltd.	13/03/2015	2921950	15159065.0	
2922143	CANON KABUSHIKI KAISHA	19/03/2015	2922143	15159932.1	
2923215	MTU America Inc.	29/10/2013	2923215	13852146.3	
2923227	Commissariat à l'Energie Atomique et aux Energies Alternatives	12/11/2013	2923227	13789797.1	French
2923648	Ethicon Endo-Surgery, Inc.	26/03/2015	2923648	15161139.9	
2924010	Wesner, Wolfgang Kurzmann, Heimo	16/03/2015	2924010	15159150.0	German
2926042	Petrolvalves S.p.A.	29/11/2013	2926042	13802302.3	
2926317	Harman International Industries, Incorporated	03/12/2012	2926317	12889460.7	
2926465	Koninklijke Philips N.V.	26/11/2013	2926465	13795515.9	
2926896	China Energy Investment Corporation Limited National Institute of Clean-and-Low- Carbon Energy	27/11/2012	2926896	12889135.5	
2927086	ALSTOM Transport Technologies	02/04/2014	2927086	14163240.6	
2927579	Harman Professional Denmark ApS	01/04/2015	2927579	15162167.9	
2928011	Andrew Wireless Systems GmbH	02/04/2014	2928011	14163187.9	

2928627	M.E.P. Macchine Elettroniche Piegatrici S.p.A.	04/12/2013	2928627	13824334.0	
2930568	Canon Kabushiki Kaisha	05/12/2012	2930568	12889426.8	
2931025	Nunhems B.V.	12/12/2013	2931025	13803041.6	
2931788	BASF SE	02/12/2013	2931788	13798349.0	German
2932022	Weatherford Technology Holdings, LLC	13/12/2013	2932022	13814777.2	
2933471	Kawasaki Jukogyo Kabushiki Kaisha	12/11/2013	2933471	13865742.4	
2933553	Koito Manufacturing Co., Ltd.	26/11/2013	2933553	13863455.5	
2933645	Dialog Semiconductor (UK) Limited	16/04/2014	2933645	14392004.9	
2934093	Max-Planck-Gesellschaft zur Förderung der Wissenschaften e.V.	20/12/2013	2934093	13814963.8	
2934647	Volcano Corporation	19/12/2013	2934647	13863790.5	
2934661	Fresenius Medical Care Holdings, Inc.	05/11/2013	2934661	13868466.7	
2934956	Huf Hülsbeck & Fürst GmbH & Co. KG	18/12/2013	2934956	13814514.9	German
2935459	SABIC Global Technologies B.V.	19/12/2013	2935459	13821567.8	
2935936	Audi AG	09/12/2013	2935936	13807932.2	German
2936047	Technip France	18/12/2013	2936047	13808055.1	French
2936116	Koninklijke Philips N.V.	19/12/2013	2936116	13865548.5	
2936649	Robert Bosch GmbH	18/12/2013	2936649	13815469.5	German
2936767	Airbus DS SAS	18/11/2013	2936767	13814031.4	French
2938796	Kiekert Aktiengesellschaft	23/12/2013	2938796	13840162.5	German
2938936	Bosch Automotive Service Solutions Inc. Robert Bosch GmbH	27/12/2013	2938936	13866717.5	
2939120	Western Digital Technologies, Inc.	24/09/2013	2939120	13867022.9	
2939446	Wandisco, Inc.	04/10/2013	2939446	13867648.1	
2939619	Synaptic Medical (Beijing) Co. Ltd.	27/12/2013	2939619	13868498.0	
2940446	Johnson & Johnson Surgical Vision, Inc.	08/12/2010	2940446	15172678.3	
2940456	Nuctech Company Limited Tsinghua University	17/12/2013	2940456	13867688.7	
2940595	Huawei Technologies Co., Ltd.	06/08/2013	2940595	13869846.9	
2941830	Huawei Technologies Co., Ltd.	19/12/2013	2941830	13820760.0	
2941905	IOT Holdings, Inc.	23/12/2013	2941905	13824062.7	
2942667	Samsung Electronics Co., Ltd.	06/05/2015	2942667	15166555.1	

2942903	Alcatel Lucent	08/05/2014	2942903	14290143.8	
2943460	H. Lundbeck A/S	19/12/2013	2943460	13811511.8	
2944272	Covidien LP	12/05/2015	2944272	15167341.5	
2944766	IHI Corporation	26/12/2013	2944766	13870737.7	
2945045	Samsung Electronics Co., Ltd.	18/05/2015	2945045	15167937.0	
2946937	Jet-Set Srl	21/05/2015	2946937	15168738.1	
2947383	ZG Lighting France S.A.	31/03/2014	2947383	14290085.1	
2948549	Industry and Academia Cooperation Foundation, Myongji University	21/05/2014	2948549	14800862.6	
2949376	Mitsubishi Heavy Industries, Ltd.	18/11/2013	2949376	13872944.7	
2949539	Dellner Couplers AB	28/05/2014	2949539	14001858.1	
2949846	Grass GmbH	13/05/2015	2949846	15167464.5	German
2949971	Iseki & Co., Ltd.	22/05/2015	2949971	15168916.3	
2950742	CA DIGITAL GmbH	22/01/2014	2950742	14701102.7	German
2952280	FANUC CORPORATION	27/05/2015	2952280	15169405.6	
2952535	Shengyi Technology Co., Ltd	26/11/2014	2952535	14194969.3	
2953417	Huawei Technologies Co., Ltd.	22/02/2013	2953417	13875754.7	
2954437	ARRIS Enterprises LLC	19/03/2014	2954437	14724874.4	
2955454	Lennox Industries Inc.	28/05/2015	2955454	15169692.9	
2955466	John Bean Technologies AB	13/06/2014	2955466	14172406.2	
2957488	Reich KG, Regel- und Sicherheitstechnik	15/12/2014	2957488	14198020.1	German
2958203	NGK Spark Plug Co., Ltd.	12/02/2014	2958203	14752103.3	
2959583	Robert Bosch GmbH	27/12/2013	2959583	13814573.5	German
2961222	Intel Corporation	05/05/2015	2961222	15166430.7	
2962052	Loebig, James Carl Dejulio, Emil	03/03/2014	2962052	14711668.5	
2962579	Guangdong Golden Leaf Technology Development Co., Ltd.	24/09/2013	2962579	13876400.6	
2963005	Daikin Industries, Ltd.	27/10/2011	2963005	15176250.7	
2963222	JOSKO Fenster und Türen GmbH	13/10/2008	2963222	14004132.8	German
2963976	Samsung Electronics Co., Ltd.	28/02/2014	2963976	14756836.4	
2964066	Aktiebolaget Electrolux	04/03/2013	2964066	13707851.5	
2964929	United Technologies Corporation	06/03/2014	2964929	14760264.3	
2964963	Volvo Construction Equipment AB	06/03/2013	2964963	13877325.4	
2966631	Fujitsu Limited	07/03/2013	2966631	13877418.7	
2966935	Miele & Cie. KG	24/06/2015	2966935	15173634.5	German

2967164	NIKE Innovate C.V.	07/03/2014	2967164	14769077.0
2967498	Muffin Incorporated	06/03/2014	2967498	14770405.0
2967891	Catalyst OrthoScience Inc.	07/03/2014	2967891	14715744.0
2967947	W. L. Gore & Associates, Inc.	21/02/2014	2967947	14709483.3
2968029	DSG Technology Holdings Ltd.	15/03/2014	2968029	14763071.9
2968251	BioMarin Pharmaceutical Inc.	14/03/2014	2968251	14717027.8
2968258	Janssen Pharmaceutica NV	07/03/2014	2968258	14717254.8
2968853	QXMedical, LLC	14/03/2014	2968853	14770886.1
2969039	JB Scientific, LLC	14/03/2014	2969039	14768448.4
2969183	Albemarle Corporation	14/03/2014	2969183	14719991.3
2969216	Eurotrol B.V.	11/03/2014	2969216	14714403.4
2969694	Bosch Automotive Service Solutions Inc. Robert Bosch GmbH	14/03/2014	2969694	14764330.8
2970025	Rolls-Royce Corporation	30/12/2013	2970025	13821420.0
2970340	Venatorx Pharmaceuticals, Inc.	13/03/2014	2970340	14767664.7
2970662	Covestro LLC	11/03/2014	2970662	14807139.2
2970847	Hale, Matthew	17/03/2014	2970847	14764523.8
2970890	The Brigham and Women's Hospital, Inc. Massachusetts Institute of Technology	11/03/2014	2970890	14774723.2
2971549	Rolls-Royce Corporation Rolls-Royce North American Technologies, Inc.	23/12/2013	2971549	13822050.4
2971692	United Technologies Corporation	18/12/2013	2971692	13878455.8
2972006	RMH Tech LLC	12/03/2014	2972006	14729094.4
2972841	Intel Corporation	13/03/2013	2972841	13878300.6
2973360	Vyaire Medical Capital LLC	03/09/2013	2973360	13878057.2
2973506	Illinois Tool Works Inc.	24/02/2014	2973506	14709129.2
2973513	Lincoln Global, Inc.	11/03/2014	2973513	14720220.4
2973735	Britt, Edward, J. Dick, Reay, S. Wipke, W., Todd	17/03/2014	2973735	14764083.3
2973769	Magarray, Inc.	13/03/2014	2973769	14770327.6
2974721	Nanomega Medical Corporation	16/07/2015	2974721	15177007.0
2975672	Prologium Holding Inc.	15/07/2015	2975672	15176749.8
2975826	Cisco Technology, Inc.	06/07/2015	2975826	15175526.1

2976011	Smith&Nephew, Inc.	18/03/2014	2976011	14725825.5	
2976320	Röhm GmbH	13/03/2014	2976320	14709671.3	
2977146	Wezag GmbH Werkzeugfabrik	21/07/2014	2977146	14177831.6	German
2977511	Japan Tobacco Inc.	20/03/2014	2977511	14768356.9	
2977779	JEOL Ltd.	22/07/2015	2977779	15177829.7	
2978210	CANON KABUSHIKI KAISHA	13/12/2011	2978210	15179044.1	
2978779	Hilti Aktiengesellschaft	26/03/2014	2978779	14712313.7	German
2979388	Kandou Labs, S.A.	15/04/2014	2979388	14785898.9	
2979389	Nokia Technologies Oy	25/03/2013	2979389	13880466.1	
2979602	Vorwerk & Co. Interholding GmbH	20/07/2015	2979602	15177489.0	German
2980484	Mitsubishi Hitachi Power Systems, Ltd.	17/10/2008	2980484	15181698.0	
2981135	Sony Corporation	10/12/2013	2981135	13880113.9	
2981530	Xavier University of Louisiana United States of America, as Represented by the Secretary of Agriculture The Administrators of the Tulane Educational Fund	04/04/2014	2981530	14780030.4	
2981856	Sky Motion Research, ULC	04/04/2014	2981856	14779873.0	
2982183	Nokia Technologies Oy	05/04/2013	2982183	13720170.3	
2982364	FUJIFILM Corporation	25/03/2014	2982364	14779760.9	
2982536	Toyota Jidosha Kabushiki Kaisha	06/08/2015	2982536	15180059.6	
2983755	SANOFI	08/04/2014	2983755	14715909.9	
2983923	Unilin, BVBA	04/04/2014	2983923	14726412.1	
2984701	MAHLE Behr GmbH & Co. KG	27/03/2014	2984701	14713465.4	German
2984766	Telefonaktiebolaget LM Ericsson (publ)	22/03/2013	2984766	13878771.8	
2986157	N.V. Nutricia	08/04/2014	2986157	14717516.0	
2986214	DexCom, Inc.	20/02/2014	2986214	14714784.7	
2986396	Oerlikon Surface Solutions AG, Pfäffikon	14/04/2014	2986396	14720893.8	German
2988175	Kyocera Document Solutions Inc.	17/07/2015	2988175	15177185.4	
2988514	Qube Cinema Technologies Private Limited	09/08/2015	2988514	15180320.2	
2988930	Pilkington Group Limited	25/04/2014	2988930	14719844.4	
2989570	F.HOFFMANN-LA ROCHE AG	22/04/2014	2989570	14718975.7	
2989689	Ventus IP Holdings, LLC	18/12/2013	2989689	13883068.2	
2989744	Thales eSecurity, Inc.	28/04/2014	2989744	14832548.3	

2989953	Wessel-Werk GmbH	19/08/2015	2989953	15181548.7	German
2990186	Bauer Hockey Ltd.	02/07/2008	2990186	15188415.2	
2990245	REMIS Gesellschaft für Entwicklung und Vertrieb von technischen Elementen mbH Köln	27/08/2014	2990245	14182542.2	German
2991571	Spinal Generations, LLC	25/04/2014	2991571	14734270.3	
2991776	Grenova, Inc.	30/04/2014	2991776	14731849.7	
2991897	AeroVironment, Inc.	05/05/2014	2991897	14828680.0	
2992726	Qualcomm Incorporated	30/04/2014	2992726	14730274.9	
2992736	Tridonic GmbH & Co KG	30/04/2014	2992736	14731539.4	German
2993304	United Technologies Corporation	07/09/2015	2993304	15184019.6	
2993831	BSH Hausgeräte GmbH	21/08/2015	2993831	15181894.5	German
2994315	Giesecke+Devrient Currency Technology GmbH	05/05/2014	2994315	14724639.1	German
2994726	DIGI SENS Holding AG	05/05/2014	2994726	14724989.0	German
2995336	Freudenberg Medical, LLC	25/08/2015	2995336	15182404.2	
2995803	MAN Truck & Bus SE	06/05/2015	2995803	15001345.6	German
2996016	Sony Interactive Entertainment Inc.	09/05/2013	2996016	13884361.0	
2996169	LG Display Co., Ltd.	07/06/2013	2996169	13840137.7	
2996580	BALT USA LLC	11/04/2014	2996580	14782510.3	
2996861	Gneuss GmbH	28/04/2014	2996861	14724019.6	German
2996998	BNZ Materials, Inc.	16/05/2014	2996998	14797893.6	
2997428	Hexagon Technology Center GmbH	15/05/2014	2997428	14734303.2	
2998138	Carrier Corporation	07/09/2015	2998138	15184097.2	
2998738	Konica Minolta, Inc.	24/03/2014	2998738	14798175.7	
2999171	Huawei Technologies Co., Ltd.	28/06/2013	2999171	13888243.6	
2999233	Kyocera Corporation	20/08/2015	2999233	15181659.2	
2999257	Sony Corporation	01/04/2014	2999257	14797706.0	
2999910	Severn Trent Water Limited	22/05/2014	2999910	14734897.3	
3000207	NEC Corporation	06/08/2013	3000207	13759451.1	
3000351	Trisa Holding AG	07/09/2005	3000351	15187837.8	German
3000446	Biotronik AG	24/06/2015	3000446	15173651.9	German
3000787	RESEARCH INSTITUTE OF INDUSTRIAL SCIENCE & TECHNOLOGY POSCO Chemical Co., Ltd POSCO	09/04/2014	3000787	14801889.8	

3001155	Tokheim Holding B.V.	11/09/2015	3001155	15184851.2	French
3002056	CTC Analytics AG	03/10/2014	3002056	14003419.0	German
3002654	Rockwell Automation Technologies, Inc.	01/10/2015	3002654	15188021.8	
3002836	Lumentum Operations LLC	23/12/2014	3002836	14200180.9	
3002981	Huawei Device Co., Ltd.	21/03/2014	3002981	14886430.9	
3003284	Fibrogen, Inc.	05/06/2014	3003284	14735770.1	
3003960	Chhliar, Jitender The Coca-Cola Company	04/06/2014	3003960	14736134.9	
3004190	Dow Global Technologies LLC Rohm and Haas Company	30/05/2013	3004190	13885680.2	
3004839	FOSS Analytical A/S	04/06/2013	3004839	13729626.5	
3004902	IEP2 Research Pty Limited	10/06/2014	3004902	14807143.4	
3005057	General Electric Company	06/05/2014	3005057	14803840.9	
3005840	Texas Instruments Incorporated	09/06/2014	3005840	14807686.2	
3006091	Stöbich Brandschutz GmbH	08/10/2015	3006091	15188957.3	German
3006239	Toyota Shatai Kabushiki Kaisha	16/09/2015	3006239	15185545.9	
3006514	Fundació Eurecat	16/04/2014	3006514	14727572.1	
3007219	Fuji Electric Co., Ltd.	10/12/2014	3007219	14879151.0	
3007510	ZTE Corporation	24/04/2014	3007510	14788354.0	
3008885	Microsoft Technology Licensing, LLC	11/06/2014	3008885	14735798.2	
3009462	Industrial Technology Research Institute	13/10/2015	3009462	15189620.6	
3009951	NCR Corporation	01/10/2015	3009951	15187883.2	
3010676	SAFRAN AIRCRAFT ENGINES	06/06/2014	3010676	14733279.5	French
3011168	Tidal Generation Limited	10/06/2014	3011168	14730971.0	
3011236	Schott Solar AG	17/06/2014	3011236	14731611.1	German
3011293	General Electric Company	30/04/2014	3011293	14729142.1	
3011407	Western Digital Technologies, Inc.	18/06/2014	3011407	14814486.8	
3011494	Tata Consultancy Services Limited	09/06/2014	3011494	14817638.1	
3012172	Nippon Steel Corporation	19/06/2014	3012172	14814492.6	
3012399	Kanto Natural Gas Development Co., Ltd.	26/03/2014	3012399	14867591.1	
3012577	4d Sensor Inc.	30/06/2014	3012577	14896934.8	
3013016	FUJITSU LIMITED	15/06/2015	3013016	15172071.1	
3013069	Taiyo Yuden Co., Ltd.	17/09/2015	3013069	15002698.7	
3013070	Oticon A/S	21/10/2015	3013070	15190783.9	

3013568	3M Innovative Properties Company	16/06/2014	3013568	14739302.9	
3013687	The Boeing Company	03/04/2014	3013687	14727287.6	
3013749	Solvay SA	26/06/2014	3013749	14735513.5	French
3013757	WPL Limited	22/05/2014	3013757	14728608.2	
3013931	Unilever PLC, a company registered in England and Wales under company no. 41424	16/06/2014	3013931	14732137.6	
3014784	Cisco Technology, Inc.	11/06/2014	3014784	14738941.5	
3016259	MediaTek Singapore Pte. Ltd.	07/10/2015	3016259	15188692.6	
3017033	Corbion Biotech, Inc.	03/07/2014	3017033	14745206.4	French
3017481	3M Innovative Properties Company	25/06/2014	3017481	14740097.2	
3017546	Xilinx, Inc.	09/04/2014	3017546	14724269.7	
3017950	Seiko Epson Corporation	05/11/2015	3017950	15193220.9	
3018767	Tyco Electronics Services GmbH TE Connectivity Corporation	03/11/2015	3018767	15192692.0	
3019191	Regeneron Pharmaceuticals, Inc.	10/07/2014	3019191	14748342.4	
3019790	Goldeneye, Inc	10/07/2014	3019790	14822476.9	
3020634	The Boeing Company	11/11/2015	3020634	15194150.7	
3021577	Nikon Corporation	04/07/2014	3021577	14823363.8	
3021785	Honig, Iulian	16/07/2014	3021785	14825733.0	
3022255	University of Maine System Board of Trustees	17/07/2014	3022255	14826568.9	
3022350	LG Electronics Inc.	17/07/2014	3022350	14826780.0	
3022363	Caterpillar SARL	18/07/2014	3022363	14741303.3	
3022616	General Electric Company	14/05/2014	3022616	14731462.9	
3023187	Qualicaps Co., Ltd.	15/07/2014	3023187	14826349.4	
3023500	uniQure IP B.V.	20/06/2007	3023500	15198010.9	
3023788	The General Hospital Corporation Dana-Farber Cancer Institute, Inc.	16/05/2011	3023788	15198284.0	
3024072	Wirtz Manufacturing Co., Inc.	19/05/2009	3024072	15199982.8	
3024534	Physio-Control, Inc.	25/07/2014	3024534	14829980.3	
3024677	TOYOTA JIDOSHA KABUSHIKI KAISHA	23/07/2014	3024677	14758417.1	
3025386	SAFT	23/07/2014	3025386	14741919.6	
3026408	HAMAMATSU PHOTONICS K.K.	25/11/2015	3026408	15196379.0	
3027079	L'OREAL	31/07/2014	3027079	14752575.2	French
3027166	Evonik Operations GmbH	01/07/2014	3027166	14734474.1	German

3027477	TOYOTA JIDOSHA KABUSHIKI KAISHA	11/07/2014	3027477	14759263.8	
3027499	Thales	30/07/2014	3027499	14745131.4	French
3027802	Koninklijke Philips N.V.	23/07/2014	3027802	14748146.9	
3027906	Whirlpool S.A.	30/07/2014	3027906	14752545.5	
3028021	Pyreos Ltd.	25/07/2014	3028021	14744323.8	German
3028440	HP Indigo B.V.	31/07/2013	3028440	13742650.8	
3028478	Qualcomm Incorporated	01/08/2014	3028478	14753397.0	
3028777	Fidica GmbH & Co. KG	21/11/2015	3028777	15003320.7	German
3028783	NIPPON STEEL Stainless Steel Corporation Kotobuki Sangyo Co., Ltd.	12/11/2014	3028783	14863868.7	
3028952	Ardagh MP Group Netherlands B.V.	01/12/2014	3028952	14195688.8	
3029149	Institució Catalana de Recerca i Estudis Avançats (ICREA) Fundació Centre de Regulació Genòmica	03/12/2014	3029149	14196170.6	
3030367	Wisys Technology Foundation, Inc.	06/08/2014	3030367	14834540.8	
3030598	SunCoal Industries GmbH	08/08/2014	3030598	14761802.9	German
3030600	Maxbiogas GmbH	10/12/2013	3030600	13811832.8	
3030973	Oshyn, Inc.	07/08/2014	3030973	14834461.7	
3031123	Energous Corporation	09/06/2014	3031123	14818136.5	
3031882	JX Nippon Oil & Energy Corporation	26/06/2014	3031882	14835338.6	
3032106	PFEIFFER VACUUM GMBH	17/07/2015	3032106	15177253.0	German
3032123	Mitsubishi Hitachi Power Systems, Ltd.	10/12/2015	3032123	15199290.6	
3032311	LG Innotek Co., Ltd.	04/12/2015	3032311	15197946.5	
3032631	Hamilton Sundstrand Space Systems International, Inc.	10/12/2015	3032631	15199305.2	
3033247	Volkswagen Aktiengesellschaft	07/08/2014	3033247	14755040.4	German
3033378	Dow Global Technologies LLC	15/08/2014	3033378	14755959.5	
3033421	General Electric Company	14/08/2014	3033421	14752322.9	
3033475	Transocean Innovation Labs Ltd	15/08/2014	3033475	14836069.6	
3033859	Bayerische Motoren Werke Aktiengesellschaft	22/07/2014	3033859	14744040.8	German
3033911	Nokia Solutions and Networks Oy	16/08/2013	3033911	13891442.9	
3033998	RAUMEDIC AG	15/12/2015	3033998	15200215.0	German
3034278	Airbus Defence and Space GmbH	19/12/2014	3034278	14004303.5	German

3034280	Airbus Operations Limited	17/12/2015	3034280	15200714.2	
3034602	Yokogawa Electric Corporation	02/12/2015	3034602	15197563.8	
3034745	dormakaba Deutschland GmbH	18/12/2014	3034745	14199032.5	German
3034754	dormakaba Deutschland GmbH	17/12/2014	3034754	14198570.5	German
3035452	Komax Holding AG	17/12/2014	3035452	14198600.0	German
3038209	Palo Alto Research Center, Incorporated	14/12/2015	3038209	15199969.5	
3038302	ZTE Corporation	16/04/2014	3038302	14794779.0	
3038382	Oticon A/S	17/12/2015	3038382	15200730.8	
3039044	BASF SE	20/03/2014	3039044	14711267.6	
3040143	Kyocera Corporation	27/08/2014	3040143	14840060.9	
3040391	LG Chem, Ltd.	29/07/2014	3040391	14841138.2	
3040627	LG Electronics Inc.	19/08/2015	3040627	15181488.6	
3041077	LG Chem, Ltd.	29/08/2014	3041077	14851775.8	
3041137	ABB Schweiz AG	29/12/2014	3041137	14200391.2	
3041280	Xiaomi Inc.	21/12/2015	3041280	15201521.0	
3041423	Aesculap AG	03/09/2014	3041423	14842742.0	
3041659	KHS Corpoplast GmbH	05/08/2014	3041659	14747842.4	German
3041756	Goodrich, David Paul	08/09/2014	3041756	14843068.9	
3041956	Memorial Sloan-Kettering Cancer Center	05/09/2014	3041956	14842562.2	
3042631	Cook Medical Technologies LLC	10/08/2010	3042631	16156978.5	
3043107	Valeo Vision	05/01/2016	3043107	16150244.8	French
3043448	Mitsubishi Electric Corporation	02/09/2013	3043448	13892440.2	
3043524	Huawei Technologies Co., Ltd.	15/09/2014	3043524	14844362.5	
3043635	Pioneer Hi-Bred International, Inc.	11/09/2014	3043635	14843248.7	
3043691	Electrolux Appliances Aktiebolag	13/09/2013	3043691	13765333.3	
3043754	Boston Scientific Scimed, Inc.	11/09/2014	3043754	14771739.1	
3044134	Krones AG	13/08/2014	3044134	14752825.1	German
3044583	Steinfurth Mess-Systeme GmbH	09/09/2014	3044583	14766677.0	German
3044926	Cisco Technology, Inc.	11/09/2014	3044926	14771737.5	
3045222	IHI Corporation	10/09/2014	3045222	14843423.6	
3046548	Centrient Pharmaceuticals Netherlands B.V.	18/09/2014	3046548	14766730.7	
3046772	Hewlett-Packard Development Company, L.P.	17/09/2013	3046772	13893994.7	
3046904	GE Healthcare Limited	19/09/2014	3046904	14767023.6	

3047423	Integrated Solutions International LLC	16/09/2014	3047423	14777999.5	
3047578	GE Oil & Gas UK Limited	18/09/2014	3047578	14772196.3	
3047766	BSH Hausgeräte GmbH	29/12/2015	3047766	15202880.9	German
3047844	ALLERGAN Industrie, SAS	24/11/2008	3047844	16154776.5	
3047981	Sumitomo Rubber Industries, Ltd.	02/10/2014	3047981	14853854.9	
3049915	VIA Alliance Semiconductor Co., Ltd.	14/12/2014	3049915	14891604.2	
3050414	Square, Inc.	23/09/2014	3050414	14850478.0	
3051681	STMicroelectronics (Tours) SAS STMicroelectronics, Inc.	09/11/2015	3051681	15193590.5	French
3051860	Samsung Electronics Co., Ltd.	23/09/2014	3051860	14848467.8	
3052272	ECA Medical Instruments	30/09/2014	3052272	14850580.3	
3052442	Molecular Rebar Design, LLC	29/09/2014	3052442	14790839.6	
3052995	Schneider Electric USA, Inc.	30/09/2013	3052995	13894192.7	
3053581	National University Corporation Tokyo University of Agriculture and Technology Taiho Pharmaceutical Co., Ltd.	29/09/2014	3053581	14849595.5	
3054454	AUSTRALIAN NUCLEAR SCIENCE & TECHNOLOGY ORGANISATION	02/06/2011	3054454	16162372.3	
3054467	CAF Power & Automation, S.L.U.	03/10/2014	3054467	14850418.6	
3054611	Kuang-chi Innovative Technology Ltd.	06/06/2014	3054611	14847931.4	
3054819	Kenwood Limited	09/10/2014	3054819	14790675.4	
3054862	Technion Research & Development Foundation Ltd.	07/10/2014	3054862	14851843.4	
3056040	Nokia Solutions and Networks Oy	02/05/2014	3056040	14852611.4	
3056178	Hill-Rom Services, Inc.	07/06/2011	3056178	16163826.7	
3056260	Helmholtz-Zentrum Geesthacht Zentrum für Material- und Küstenforschung GmbH	16/02/2015	3056260	15155179.3	German
3056274	NGK Insulators, Ltd.	30/09/2014	3056274	14851889.7	
3056882	Vorwerk & Co. Interholding GmbH	13/02/2015	3056882	15154990.4	German
3057351	ZTE Corporation	31/03/2014	3057351	14794900.2	
3057363	Huawei Technologies Co., Ltd.	31/10/2013	3057363	13896244.4	
3057410	Snpsht Trustee Limited	17/10/2014	3057410	14853667.5	
3058745	Qualcomm Incorporated	14/10/2014	3058745	14792944.2	
3058751	Audeze, LLC	17/10/2014	3058751	14854670.8	
3058791	Sony Corporation	09/10/2014	3058791	14805365.5	

3058811	Verdesian Life Sciences U.S., LLC	27/08/2014	3058811	16161780.8	
3059154	Ferreira Marinho, José Manuel	20/10/2014	3059154	14816394.2	
3059920	Siemens Aktiengesellschaft	20/02/2015	3059920	15155966.3	
3059989	ZTE Corporation	05/05/2014	3059989	14797756.5	
3060449	Kawasaki Jukogyo Kabushiki Kaisha	25/10/2013	3060449	13799116.2	
3060519	Council of Scientific and Industrial Research	22/10/2014	3060519	14821297.0	
3061390	Samsung Electronics Co., Ltd.	26/02/2016	3061390	16157721.8	
3061570	Shanghai Easy-Use Tools Enterprise Co. Ltd.	06/11/2013	3061570	13896157.8	
3061680	HONDA MOTOR CO., LTD.	25/02/2016	3061680	16157267.2	
3062547	Alcatel Lucent	26/02/2015	3062547	15305298.0	
3062725	Brainlab AG	28/10/2013	3062725	13785409.7	
3062834	Fresenius Medical Care AG & Co. KGaA Fresenius Medical Care Deutschland GmbH	31/10/2014	3062834	14792514.3	German
3063053	Sika Technology AG	29/10/2014	3063053	14790608.5	
3063393	Jaguar Land Rover Limited	16/10/2014	3063393	14784254.6	
3063608	Apple Inc.	30/10/2013	3063608	13795330.3	
3063783	Ricoh Company, Ltd.	23/10/2014	3063783	14856937.9	
3063826	Maury Microwave, Inc.	28/10/2014	3063826	14805704.5	
3063828	Institut Francais de Recherche pour l'Exploitation de la Mer (IFREMER)	24/10/2014	3063828	14789279.8	French
3064386	Inalfa Roof Systems Group B.V.	04/03/2015	3064386	15157573.5	
3064410	Mitsubishi Jidosha Kogyo Kabushiki Kaisha	03/03/2016	3064410	16158368.7	
3064572	BBHC Co. Ltd.	01/11/2013	3064572	13896647.8	
3064821	Jimten, S.A.	20/05/2015	3064821	15826892.0	
3065257	Intel Corporation	11/12/2009	3065257	16165755.6	
3065339	American Teleconferencing Services, Ltd.	30/04/2010	3065339	16166442.0	
3065606	CMA Macchine per caffè S.r.l.	27/05/2015	3065606	15738974.3	
3065714	Janssen Sciences Ireland Unlimited Company	05/11/2014	3065714	14793168.7	
3066553	Fujitsu Limited	30/06/2014	3066553	14733655.6	
3067155	E & Q One-Touch	27/11/2014	3067155	14900065.5	

3067371	Taiyo Ink Mfg. Co., Ltd.	30/09/2014	3067371	14860632.0	
3067960	Samsung SDI Co., Ltd.	08/03/2016	3067960	16159227.4	
3068054	BlackBerry Limited	09/03/2016	3068054	16159322.3	
3068426	NMBU Veterinærhøgskolen Veterinærinstituttet University of Oslo	13/11/2014	3068426	14835493.9	
3068871	Agency for Science, Technology and Research	11/11/2014	3068871	14859928.5	
3068966	Baker Hughes, a GE company, LLC	13/11/2014	3068966	14861855.6	
3069496	Microsoft Technology Licensing, LLC	03/11/2014	3069496	14805405.9	
3070178	Albert-Ludwigs-Universität Freiburg	20/03/2015	3070178	15160154.9	
3070209	Grohe AG	08/03/2016	3070209	16000557.5	German
3070424	Whirlpool Corporation	17/03/2016	3070424	16160961.5	
3070485	Analog Devices, Inc.	03/03/2016	3070485	16158456.0	
3073014	Wirtgen GmbH	01/03/2010	3073014	16168065.7	German
3073879	Kenwood Limited	24/11/2014	3073879	14805334.1	
3073892	Trice Medical, Inc.	26/11/2014	3073892	14865218.3	
3074208	Voxeljet AG	26/11/2014	3074208	14833112.7	German
3074252	Thermo King Corporation	03/06/2014	3074252	14863536.0	
3074344	Merck Patent GmbH	31/10/2014	3074344	14793454.1	
3074650	Emerson Climate Technologies, Inc.	26/11/2014	3074650	14866025.1	
3074874	Qualcomm Incorporated	21/11/2014	3074874	14812844.0	
3075105	Bridgeworks Limited	28/11/2014	3075105	14806378.7	
3075145	United Kingdom Research and Innovation	28/11/2014	3075145	14806379.5	
3075342	Allm Inc.	21/11/2014	3075342	14866443.6	
3075353	NIDEK CO., LTD	29/03/2016	3075353	16162653.6	
3075556	Seiko Epson Corporation	16/03/2016	3075556	16160661.1	
3076274	HiDeep Inc.	18/09/2015	3076274	16152699.1	
3077415	Yissum Research Development Company of the Hebrew University of Jerusalem Ltd. Atox Bio Ltd.	07/12/2014	3077415	14830734.1	
3077476	Nexdot	04/12/2014	3077476	14809375.0	
3077641	United Technologies Corporation	04/12/2014	3077641	14868231.3	
3078044	Maschinenfabrik Reinhausen GmbH	03/12/2014	3078044	14809350.3	German

3078391	Kutyev, Anatoly Anatolyevich Konin, Andrey Vasilyevich	04/12/2014	3078391	14868487.1	
3078644	IL Metronic Sensortechnik GmbH	05/04/2016	3078644	16163875.4	German
3078703	Dexerials Corporation	19/11/2014	3078703	14867051.6	
3078792	Nifco Inc.	27/11/2014	3078792	14868280.0	
3078910	PBS Power Equipment s.r.o. Vysoké Učení Technické V Brne	08/04/2015	3078910	15162738.7	
3079675	CONARIS research institute AG	12/12/2014	3079675	14809908.8	
3080163	EnCare Biotech B.V.	12/12/2014	3080163	14828328.6	
3080189	Victrix Manufacturing Limited	08/12/2014	3080189	14809698.5	
3080271	University of Tokyo The Broad Institute, Inc. Massachusetts Institute of Technology President and Fellows of Harvard College	12/12/2014	3080271	14827609.0	
3080341	Analiza, Inc.	09/12/2014	3080341	14870632.8	
3080674	Rosenbauer International AG	05/12/2014	3080674	14835615.7	German
3080867	IEE International Electronics & Engineering S.A.	28/11/2014	3080867	14803169.3	
3080933	Khalifa University of Science and Technology British Telecommunications public limited company Emirates Telecommunications Corporation	09/12/2013	3080933	13815106.3	
3080950	Siemens Aktiengesellschaft	01/04/2015	3080950	15714480.9	German
3080991	Canon Kabushiki Kaisha	10/12/2014	3080991	14818919.4	
3081263	P&X Medical NV	17/04/2015	3081263	15163949.9	
3082375	China Mobile Communications Corporation	03/12/2014	3082375	14869640.4	
3082442	RDL S.r.l.	12/12/2014	3082442	14830636.8	
3082581	Koninklijke Philips N.V.	10/12/2014	3082581	14837073.7	
3083501	Rhodia Operations	16/12/2014	3083501	14815666.4	
3083660	Instytut Biotechnologii i Antybiotyków Uniwersytet Gdanski Instytut Biochemii i Biofizyki PAN	19/12/2014	3083660	14830896.8	
3083688	Alligator Bioscience AB	18/12/2014	3083688	14828028.2	

3083741	BASF SE	03/12/2014	3083741	14806263.1	German
3083949	BASF Plant Science Company GmbH	17/12/2014	3083949	14872225.9	
3084869	thyssenkrupp Marine Systems GmbH	15/12/2014	3084869	14824371.0	German
3085136	Intel IP Corporation	19/12/2013	3085136	13899946.1	
3085233	PlantResponse Biotech, S.L. Universidad Politécnica de Madrid	17/12/2014	3085233	14835701.5	
3085514	Sumitomo Rubber Industries, Ltd.	14/11/2014	3085514	14871616.0	
3086736	Koninklijke Philips N.V.	16/12/2014	3086736	14835675.1	
3086926	CooperVision International Holding Company, LP	22/12/2014	3086926	14821256.6	
3087433	L'Oreal, S.A.	19/12/2014	3087433	14833256.2	
3087672	TE Connectivity India Private Limited	22/12/2014	3087672	14833463.4	
3087922	St. Jude Medical International Holding S.à r.l.	25/12/2011	3087922	16173245.8	
3088001	National University Corporation Kochi University	25/12/2014	3088001	14873694.5	
3088268	LG Electronics Inc.	24/12/2014	3088268	14874800.7	
3088273	ALSTOM Transport Technologies	28/04/2016	3088273	16167484.1	French
3088340	Klotzner, Stefan Romani, Daniele	26/04/2016	3088340	16020160.4	
3088403	Toray Industries, Inc.	18/12/2014	3088403	14875253.8	
3088615	Xiamen Solex High-Tech Industries Co., Ltd.	25/12/2014	3088615	14875662.0	
3088710	Volvo Lastvagnar Aktiebolag	24/12/2013	3088710	13900548.2	
3089025	Ricoh Company, Ltd.	22/12/2014	3089025	14874140.8	
3089214	BOE Technology Group Co., Ltd. Hefei BOE Optoelectronics Technology Co., Ltd.	27/05/2014	3089214	14861175.9	
3089642	Samsung Electronics Co., Ltd.	30/12/2014	3089642	14876413.7	
3089806	Plastic Omnium Advanced Innovation and Research	26/12/2014	3089806	14833524.3	French
3090264	The Scripps Research Institute The Board of Trustees of the Leland Stanford Junior University	23/12/2014	3090264	14876751.0	
3090484	Tesla, Inc.	10/04/2015	3090484	15779940.4	
3090507	Telecom Italia S.p.A.	30/12/2013	3090507	13815533.8	
3090518	LG Electronics Inc.	31/12/2014	3090518	14877203.1	

3090791	Doosan Heavy Industries & Construction Co., Ltd.	04/05/2016	3090791	16168311.5	
3092443	Aduro A/S	15/12/2014	3092443	14812865.5	
3092811	InterDigital VC Holdings, Inc.	12/06/2014	3092811	14730149.3	
3094687	Sony Corporation Sony Corporation of America	16/01/2015	3094687	15736917.4	
3096188	Konica Minolta, Inc.	10/05/2016	3096188	16168933.6	
3096209	Xiaomi Inc.	10/05/2016	3096209	16169063.1	
3096433	Samsung Electronics Co., Ltd.	19/05/2016	3096433	16170408.5	
3097653	Huawei Technologies Co., Ltd.	13/02/2015	3097653	15751964.6	
3098104	Toyota Jidosha Kabushiki Kaisha	26/05/2016	3098104	16171523.0	
3098171	Ishida Co., Ltd.	08/12/2014	3098171	14878929.0	
3098698	Kunshan New Flat Panel Display Technology Center Co., Ltd. Kunshan Go-Visionox Opto-Electronics Co., Ltd.	25/12/2014	3098698	14873309.0	
3098866	Murata Manufacturing Co., Ltd.	17/10/2014	3098866	14879607.1	
3098921	ABB Schweiz AG	26/05/2016	3098921	16171583.4	
3100600	Siemens Aktiengesellschaft	20/03/2014	3100600	14715225.0	German
3100616	Hill's Pet Nutrition, Inc.	30/12/2005	3100616	16180409.1	
3101279	Hamilton Sundstrand Corporation	31/03/2016	3101279	16163333.4	
3101361	TOSHIBA MITSUBISHI-ELECTRIC INDUSTRIAL SYSTEMS CORPORATION	29/11/2013	3101361	13898214.5	
3101388	TOPCON CORPORATION	12/05/2016	3101388	16169389.0	
3101670	OMRON CORPORATION	26/04/2016	3101670	16167066.6	
3101866	Openwave Mobility, Inc.	03/06/2016	3101866	16172815.9	
3102704	University of Iowa Research Foundation	09/02/2015	3102704	15746286.2	
3102727	NIKE Innovate C.V.	12/11/2014	3102727	14812325.0	
3102810	United Technologies Corporation	14/11/2014	3102810	14880056.8	
3103383	TOMEY CORPORATION	09/06/2016	3103383	16173638.4	
3103456	Universitat de les Illes Balears	14/05/2009	3103456	16172654.2	
3103575	Ledermann GmbH & Co. KG HOLZ-HER GmbH	01/07/2011	3103575	16001554.1	German
3103680	Ningbo Xuli Metal Products Co., Ltd	20/01/2016	3103680	16748526.7	
3104012	Assoma Inc.	10/06/2016	3104012	16173924.8	

3104274	Honeywell International Inc.	26/05/2016	3104274	16171604.8	
3104304	Samsung Electronics Co., Ltd.	08/06/2016	3104304	16173591.5	
3104635	Deutsche Telekom AG	09/06/2015	3104635	15171243.7	
3104844	Druggability Technologies IP Holdco Limited	13/02/2015	3104844	15710913.3	
3106664	Edwards Limited	16/05/2016	3106664	16169804.8	
3107118	COMMISSARIAT À L'ÉNERGIE ATOMIQUE ET AUX ÉNERGIES ALTERNATIVES	16/06/2016	3107118	16174871.0	French
3107165	NAVAL GROUP	17/06/2016	3107165	16175078.1	French
3107721	Dow Global Technologies LLC Rohm and Haas Company	19/02/2015	3107721	15707232.3	
3107894	Merck Patent GmbH	18/02/2015	3107894	15705911.4	German
3108610	Phoenix Contact GmbH & Co. KG	20/02/2015	3108610	15706764.6	German
3108821	Ethicon LLC	24/06/2016	3108821	16176106.9	
3108888	United Therapeutics Corporation	14/03/2011	3108888	16182514.6	
3109007	Ingersoll-Rand Company	23/06/2016	3109007	16175913.9	
3109052	Seiko Epson Corporation	22/03/2016	3109052	16161705.5	
3109582	NIPPON STEEL NISSHIN CO., LTD.	18/02/2015	3109582	15752539.5	
3109630	Shimadzu Corporation	18/02/2014	3109630	14882930.2	
3110844	Centre For The Aids Programme of Research in South Africa National Health Laboratory Service The U.S.A. as represented by the Secretary, Department of Health and Human Services The Trustees of Columbia University in the City of New York University Of The Witwatersrand, Johannesburg	27/02/2015	3110844	15708889.9	
3110983	Centre National de la Recherche Scientifique (C.N.R.S.)	25/02/2015	3110983	15714854.5	French
3111140	Evac Oy	26/02/2015	3111140	15708860.0	
3111285	Alfred Kärcher SE & Co. KG	25/02/2014	3111285	14706586.6	German
3111616	IBOSS, Inc.	26/02/2015	3111616	15710646.9	
3111696	Telefonaktiebolaget LM Ericsson (publ)	27/02/2014	3111696	14713943.0	

3112368	ONO PHARMACEUTICAL CO., LTD.	30/05/2011	3112368	16176735.5	
3112991	Samsung Electronics Co., Ltd.	03/06/2016	3112991	16172996.7	
3114510	ZKW Group GmbH	10/11/2014	3114510	14824349.6	German
3114572	Samsung Electronics Co., Ltd.	17/02/2015	3114572	15733601.7	
3114573	Samsung Electronics Co., Ltd.	06/03/2015	3114573	15759160.3	
3114690	Intel Corporation	07/03/2014	3114690	14884884.9	
3114787	Technische Universität München	13/02/2015	3114787	15706723.2	German
3114824	Houdinix LLC	27/02/2015	3114824	15710047.0	
3115267	Airbus Operations Limited Airbus Operations SAS	01/07/2016	3115267	16177443.5	
3115454	Yamamoto, Hirofumi Mori, Masaki	04/03/2015	3115454	15757718.0	
3115648	Alps Alpine Co., Ltd.	21/06/2016	3115648	16175409.8	
3116046	AutoNetworks Technologies, Ltd. Sumitomo Wiring Systems, Ltd. Sumitomo Electric Industries, Ltd.	23/02/2015	3116046	15758692.6	
3116218	Huawei Device Co., Ltd.	18/04/2014	3116218	14889194.8	
3116574	Baska, Kanag Baska, Meenakshi	12/03/2015	3116574	15761927.1	
3116711	Saint-Gobain Performance Plastics Corporation	10/03/2015	3116711	15761095.7	
3116731	Advanced Comfort Systems France SAS - ACS France	05/03/2015	3116731	15707976.5	French
3116777	Airbus Operations Limited	13/03/2015	3116777	15710573.5	
3116891	Richter Gedeon Nyrt.	09/03/2015	3116891	15708522.6	
3117159	Electricité de France	10/03/2015	3117159	15708827.9	French
3117442	Siemens Aktiengesellschaft	12/05/2014	3117442	14726332.1	German
3117711	Marel Stork Poultry Processing B.V.	04/07/2016	3117711	16177769.3	
3117828	Sapporo Medical University	10/09/2008	3117828	16182980.9	
3118608	Beijing Institute Of Technology	13/02/2015	3118608	15760735.9	
3118852	Huawei Technologies Co., Ltd.	01/12/2014	3118852	14885786.5	
3118939	Karl Storz SE & Co. KG	12/07/2016	3118939	16178946.6	
3119270	AIT Austrian Institute of Technology GmbH	13/03/2015	3119270	15716394.0	German
3119702	Koninklijke Douwe Egberts B.V.	13/05/2016	3119702	16744561.8	
3120253	Cisco Technology, Inc.	10/03/2015	3120253	15711983.5	

3120256	Core Sports Technology Group	17/03/2015	3120256	15764196.0	
3120401	Versa Power Systems Ltd.	17/03/2015	3120401	15714093.0	
3121500	Mueller Industries, Inc.	07/06/2016	3121500	16173347.2	
3121577	Snap-on Equipment Srl a unico socio	24/07/2015	3121577	15178312.3	
3121632	Huawei Technologies Co. Ltd.	08/05/2015	3121632	15807776.8	
3121671	Fisher-Rosemount Systems, Inc.	15/05/2008	3121671	16186154.7	
3122075	Sharp Kabushiki Kaisha	13/03/2015	3122075	15764182.0	
3122084	Legic Identsystems AG	07/06/2016	3122084	16173309.2	
3122555	Hollister Incorporated	25/02/2015	3122555	15713042.8	
3122673	Plockmatic International AB	23/03/2015	3122673	15768631.2	
3123524	Power Roll Limited	27/03/2015	3123524	15713802.5	
3123636	Osram Sylvania Inc.	24/03/2015	3123636	15718656.0	
3123684	Huawei Technologies Co. Ltd.	28/03/2014	3123684	14714680.7	
3123758	Vodafone IP Licensing Limited	24/03/2015	3123758	15741808.8	
3123809	LG Electronics Inc.	30/03/2015	3123809	15769567.7	
3123860	Kingstronbio (Changshu) Co., Ltd.	24/03/2015	3123860	15767882.2	
3123908	Tsann Kuen (Zhangzhou) Enterprise Co., Ltd.	25/07/2016	3123908	16181046.0	
3124040	Merck Serono SA	28/04/2005	3124040	16188978.7	
3125516	Kabushiki Kaisha Toshiba Toshiba TEC Kabushiki Kaisha	30/07/2015	3125516	15179153.0	
3126056	Graco Minnesota Inc.	30/03/2015	3126056	15772921.1	
3126839	Ecole Polytechnique Fédérale de Lausanne (EPFL)	30/03/2015	3126839	15715701.7	
3126849	Nederlandse Organisatie voor toegepast- natuurwetenschappelijk onderzoek TNO	31/03/2015	3126849	15719859.9	
3127035	Mobile Iron, Inc.	31/03/2015	3127035	15773800.6	
3127312	British Telecommunications public limited company	23/03/2015	3127312	15714005.4	
3127313	British Telecommunications public limited company	27/03/2015	3127313	15714266.2	
3127419	Laursen, Niels Kjær	01/08/2016	3127419	16182203.6	
3128085	Sumitomo (S.H.I.) Construction Machinery Co., Ltd.	24/03/2015	3128085	15773151.4	
3128089	MEPA- Pauli und Menden GmbH	04/08/2016	3128089	16182746.4	German
3128761	Valencell, Inc.	15/11/2013	3128761	16184560.7	

3128889	SharkNinja Operating LLC	07/04/2015	3128889	15718400.3	
3129101	Universitätsklinikum Heidelberg	25/03/2015	3129101	15717429.3	
3129206	KHS Corpoplast GmbH	09/04/2015	3129206	15715167.1	German
3129502	University of Washington through its Center for Commercialization	08/04/2015	3129502	15776098.4	
3129699	Volvo Truck Corporation	09/04/2014	3129699	14889003.1	
3129849	Facebook Technologies, LLC	10/04/2015	3129849	15717422.8	
3130598	Lonza Ltd	29/10/2013	3130598	16184950.0	
3130920	Fujimori Kogyo Co., Ltd.	08/04/2015	3130920	15776057.0	
3130923	The Brigham and Women's Hospital, Inc. Children's Medical Center Corporation	13/11/2009	3130923	16177814.7	
3131435	Colgate-Palmolive Company	08/05/2014	3131435	14731858.8	
3131719	Oertli Werkzeuge AG	14/04/2015	3131719	15717077.0	German
3131731	Saint-Gobain Glass France	15/04/2015	3131731	15780081.4	
3131893	Novartis AG	16/04/2015	3131893	15719115.6	
3132630	Qualcomm Incorporated	09/03/2015	3132630	15712734.1	
3132656	Saint-Gobain Glass France	05/03/2015	3132656	15710138.7	German
3132724	Whirlpool Corporation	12/08/2016	3132724	16184070.7	
3132783	Samsung Electronics Co., Ltd.	01/04/2016	3132783	16163528.9	
3133252	Rolls-Royce plc	27/07/2016	3133252	16181409.0	
3133453	Yokogawa Electric Corporation	12/08/2016	3133453	16183993.1	
3133891	Samsung Electronics Co., Ltd. Seoul National University R&DB Foundation	01/08/2016	3133891	16182153.3	
3133953	Kan Holding AS	23/04/2015	3133953	15718219.7	
3134006	Bio-Medical Engineering (HK) Limited	22/04/2015	3134006	15782679.3	
3134161	Becton, Dickinson and Company	14/04/2015	3134161	15771302.5	
3134403	Incyte Corporation	22/04/2015	3134403	15721085.7	
3134409	Université de Montréal	21/04/2015	3134409	15782744.5	
3134790	Oceaneering International Inc.	24/04/2015	3134790	15782701.5	
3135109	ANGUS Chemical Company	29/04/2009	3135109	16192281.0	
3135642	AGC Inc.	23/04/2015	3135642	15783490.4	
3135864	Rolls-Royce Deutschland Ltd & Co KG	11/08/2016	3135864	16183865.1	German
3135915	ZHEJIANG SANHUA AUTOMOTIVE COMPONENTS CO., LTD.	23/08/2016	3135915	16185339.5	
3135976	ContiTech Kühner GmbH & Cie. KG	26/05/2016	3135976	16171451.4	German

3136008	LG ELECTRONICS INC.	28/07/2016	3136008	16181633.5	
3136079	The Regents of the University of California	19/10/2010	3136079	16193112.6	
3136552	Hitachi Industrial Equipment Systems Co., Ltd.	21/04/2014	3136552	14889869.5	
3136562	Johnson Electric International AG	01/07/2016	3136562	16177530.9	
3136980	Mellon Medical B.V.	29/04/2015	3136980	15726390.6	
3137048	L'OREAL	30/04/2015	3137048	15726719.6	
3137302	Hewlett-Packard Development Company, L.P.	30/04/2014	3137302	14890734.8	
3138620	Meura S.A.	18/08/2016	3138620	16184723.1	French
3138695	Kuroda, Takeshi	02/05/2014	3138695	14891113.4	
3139171	Labsystems Diagnostics Oy	06/10/2015	3139171	15188615.7	
3140127	OVD Kinegram AG	07/05/2015	3140127	15724532.5	German
3140332	Tubitak	07/05/2015	3140332	15729230.1	
3140347	Austrianova Singapore Pte Ltd.	08/05/2015	3140347	15789170.6	
3140425	Baylor College of Medicine	05/05/2015	3140425	15788806.6	
3140621	Fraba B.V.	28/04/2015	3140621	15719685.8	German
3140633	Robert Bosch GmbH	05/03/2015	3140633	15707679.5	German
3140770	Microsoft Technology Licensing, LLC	04/05/2015	3140770	15722864.4	
3140877	Murata Manufacturing Co., Ltd.	08/05/2015	3140877	15724077.1	
3140946	Telefonaktiebolaget LM Ericsson (publ)	11/11/2014	3140946	14799990.8	
3140977	Qualcomm Incorporated	30/04/2015	3140977	15724837.8	
3141453	Container Centralen A/S	29/08/2016	3141453	16186160.4	
3141819	LG ELECTRONICS INC.	02/09/2016	3141819	16186971.4	
3141897	Universita' Degli Studi Di Cagliari Saras Ricerche e Tecnologie S.p.A.	09/09/2016	3141897	16188167.7	
3142150	NXP USA, Inc.	08/09/2016	3142150	16187929.1	
3142328	The Boeing Company	13/09/2016	3142328	16188505.8	
3142447	China Academy of Telecommunications Technology	07/05/2015	3142447	15788880.1	
3142500	Cargill, Incorporated	13/05/2015	3142500	15792704.7	
3142602	ALLERGAN, INC.	15/05/2015	3142602	15726823.6	
3142991	Safariland, LLC	14/05/2015	3142991	15792021.6	
3143251	Baker Hughes, a GE company, LLC	07/05/2015	3143251	15792851.6	
3143252	National Oilwell Varco, L.P.	12/05/2015	3143252	15792417.6	
3143644	ABB Schweiz AG	14/05/2014	3143644	14725974.1	

3143744	Cisco Technology, Inc.	30/04/2015	3143744	15724833.7	
3144019	Dongkoo Bio & Pharma Co., Ltd.	04/05/2015	3144019	15793305.2	
3144434	Reich GmbH Regel- und Sicherheitstechnik	12/08/2016	3144434	16183983.2	German
3144899	Samsung Electronics Co., Ltd.	02/09/2016	3144899	16187083.7	
3144935	NEC Platforms, Ltd.	16/04/2015	3144935	15793636.0	
3145049	NISSAN MOTOR CO., LTD.	15/05/2014	3145049	14892070.5	
3145107	LG Electronics Inc.	30/04/2015	3145107	15792919.1	
3145117	Campanini, Fabrizio Pastore, Giuseppe	26/08/2016	3145117	16185884.0	
3145148	ZTE Corporation	13/08/2014	3145148	14894319.4	
3145339	Philip Morris Products S.A.	21/05/2015	3145339	15723967.4	
3145728	Lumenco, LLC	20/05/2014	3145728	14892272.7	
3145742	FCA US LLC	20/05/2015	3145742	15727515.7	
3145859	President and Fellows of Harvard College	22/05/2015	3145859	15802781.3	
3145916	ALLERGAN, INC.	21/05/2015	3145916	15726498.7	
3146123	Proll, Markus Claudius Schmitt, Martin	21/05/2015	3146123	15730245.6	German
3146617	Solar Cubed Development, LLC	22/05/2015	3146617	15796356.2	
3146795	Bayerische Motoren Werke Aktiengesellschaft	17/02/2015	3146795	15705296.0	German
3147027	Shimadzu Corporation	09/09/2016	3147027	16188089.3	
3147046	Casa Maristas Azterlan Ask Chemicals España, S.A.	19/05/2014	3147046	14745172.8	
3147278	University of Tennessee Research Foundation	12/07/2007	3147278	16194602.5	
3147427	Bailford Holdings Limited	24/08/2016	3147427	16185479.9	
3147542	IHI Corporation Osaka University	07/04/2015	3147542	15796595.5	
3147581	Meltem Wärmerückgewinnung GmbH & Co. KG	23/09/2003	3147581	16191049.2	German
3148298	Rayben Technologies (HK) Limited	09/05/2016	3148298	16168787.6	
3148315	The Regents of the University of California	26/05/2015	3148315	15800125.5	
3148631	Finesse Solutions, Inc.	28/05/2015	3148631	15731753.8	
3148656	Sisyphus Fitness Inc.	26/05/2015	3148656	15738774.7	

3149039	INSERM (Institut National de la Santé et de la Recherche Médicale) Université Paris Descartes	01/06/2015	3149039	15729772.2	
3149324	Stamirski, Maciej	27/02/2014	3149324	14713939.8	
3149487	Geneticure LLC	27/05/2015	3149487	15728326.8	
3149624	InterDigital CE Patent Holdings	19/05/2015	3149624	15744992.7	
3149788	East Penn Manufacturing Co.	02/06/2015	3149788	15729026.3	
3149814	Phoenix Contact GmbH & Co. KG	26/05/2015	3149814	15723980.7	German
3150070	Leisner, Anna Sarah	30/09/2015	3150070	15187678.6	German
3150168	ALLERGAN, INC.	24/07/2008	3150168	16190096.4	
3150190	Beiersdorf AG	16/09/2016	3150190	16189116.3	German
3150744	COVENTYA S.p.A.	30/09/2015	3150744	15187511.9	
3151785	Sano V Pte. Ltd.	08/06/2015	3151785	15805768.7	
3151964	Illumina, Inc.	03/06/2015	3151964	15744722.8	
3152032	Das-Nano, S.L.	06/06/2014	3152032	14731182.3	
3152033	"Print Cast" Ltd.	15/09/2014	3152033	14790482.5	
3152063	Gemalto AG Orell Füssli Sicherheitsdruck AG	05/06/2015	3152063	15726627.1	German
3152312	Regeneron Pharmaceuticals, Inc.	05/06/2015	3152312	15729724.3	
3152389	Welltec Oilfield Solutions AG	04/06/2015	3152389	15726193.4	
3152766	Westinghouse Electric Company Llc	27/03/2015	3152766	15802684.9	
3153237	Hansgrohe SE	29/07/2016	3153237	16182092.3	German
3154255	Samsung Electronics Co., Ltd.	03/06/2015	3154255	15803556.8	
3154534	University Of Rochester	12/06/2015	3154534	15735770.8	
3154653	BASF SE	09/06/2015	3154653	15729785.4	German
3154745	Hermes Schleifmittel GmbH	08/06/2015	3154745	15729392.9	German
3154983	Gilead Pharmasset LLC	08/06/2015	3154983	15730621.8	
3155131	Blueprint Medicines Corporation	10/06/2015	3155131	15795009.8	
3155319	Siemens Aktiengesellschaft	22/05/2015	3155319	15730568.1	
3155393	Bollard Load Testing Limited	02/02/2015	3155393	15708027.6	
3156360	Composyst GmbH Wittur Holding GmbH	07/10/2016	3156360	16192947.6	German
3156468	KCC Corporation	09/06/2015	3156468	15806631.6	
3156657	Shinano Kenshi Co., Ltd.	14/09/2016	3156657	16188721.1	
3156906	Google LLC	13/10/2016	3156906	16193714.9	

3156930	B.G. Negev Technologies and Applications Ltd Verint Systems Ltd	12/10/2016	3156930	16193569.7	
3157239	Timecode Systems Limited	11/10/2016	3157239	16193386.6	
3157241	Timecode Systems Limited	11/10/2016	3157241	16193388.2	
3157464	LimFlow GmbH	16/06/2015	3157464	15809082.9	
3157773	Poli-Model S.r.l. Interactive Fully Electrical Vehicles S.r.l.	19/06/2015	3157773	15739010.5	
3157838	Loop Ties LLC	18/06/2015	3157838	15809026.6	
3157996	Dow Global Technologies LLC Rohm and Haas Company	17/06/2015	3157996	15733041.6	
3158120	LG Electronics Inc.	23/06/2015	3158120	15811721.8	
3158329	Ascensia Diabetes Care Holdings AG	12/06/2015	3158329	15731466.7	
3158491	Microsoft Technology Licensing, LLC	17/06/2015	3158491	15733592.8	
3158569	Mad Apparel, Inc.	01/05/2015	3158569	15809222.1	
3158716	Western Digital Technologies, Inc.	16/06/2015	3158716	15809897.0	
3158834	Rensselaer Polytechnic Institute	16/06/2015	3158834	15808886.4	
3158902	Hemro International AG	21/10/2015	3158902	15190689.8	German
3158957	Biedermann Technologies GmbH & Co. KG	21/10/2015	3158957	15190858.9	
3159049	Kang, Too Hwan	21/10/2016	3159049	16195132.2	
3159300	COMMISSARIAT À L'ÉNERGIE ATOMIQUE ET AUX ÉNERGIES ALTERNATIVES SAFRAN ELECTRONICS & DEFENSE	20/10/2016	3159300	16194875.7	French
3159616	Samsung Electronics Co., Ltd.	04/05/2016	3159616	16168420.4	
3159642	Hamilton Sundstrand Corporation	21/10/2016	3159642	16195018.3	
3159765	MBDA Deutschland GmbH	21/10/2016	3159765	16194989.6	
3159892	Yamaha Corporation	10/06/2015	3159892	15809992.9	
3160098	Xi'an Zhongxing New Software Co. Ltd.	10/11/2014	3160098	14895401.9	
3160513	Glykos Finland Oy	26/06/2015	3160513	15742047.2	
3160558	Syqe Medical Ltd.	30/06/2015	3160558	15753782.0	
3160751	Hewlett-Packard Development Company, L.P.	30/06/2014	3160751	14747179.1	

3161038	Victrex Manufacturing Limited	26/06/2015	3161038	15732924.4	
3161148	Institut National de la Santé et de la Recherche Médicale (INSERM) Université de Montpellier Centre Hospitalier Universitaire de Montpellier	26/06/2015	3161148	15731937.7	
3161378	Siemens Aktiengesellschaft	29/10/2015	3161378	15790500.1	German
3161480	Tel HaShomer Medical Research Infrastructure and Services Ltd.	25/06/2015	3161480	15739030.3	
3161585	Intel Corporation	27/05/2015	3161585	15811305.0	
3161867	Intel Corporation	26/06/2014	3161867	14895579.2	
3162139	Sun Patent Trust	24/06/2014	3162139	14896013.1	
3162165	Linde AG	18/06/2015	3162165	15730964.2	German
3163025	General Electric Company	17/10/2016	3163025	16194236.2	
3163133	Eagle Industry Co., Ltd.	25/06/2015	3163133	15811264.9	
3163325	Nokia Technologies Oy	28/10/2015	3163325	15191855.4	
3163394	Xiaomi Inc.	21/06/2016	3163394	16175431.2	
3163422	Sony Corporation	21/04/2015	3163422	15814462.6	
3163654	Samsung SDI Co., Ltd.	25/10/2016	3163654	16195630.5	
3163837	Cisco Technology, Inc.	20/10/2016	3163837	16194909.4	
3164139	Chacon, Enrique Saenz, Xavier J.	26/06/2015	3164139	15814580.5	
3164431	BASF SE	15/06/2015	3164431	15728547.9	German
3164507	Promega Corporation	02/07/2015	3164507	15814530.0	
3164539	LG Electronics Inc.	02/07/2015	3164539	15815818.8	
3165901	China Communication Technology Co., Ltd. Shenzhen Vicetooth Terahertz Technology Co., Ltd.	14/09/2015	3165901	15899907.8	
3166311	Sony Corporation	23/06/2015	3166311	15832125.7	
3166367	HTC Corporation	03/11/2016	3166367	16197066.0	
3166422	Unitec S.p.A.	23/06/2015	3166422	15734468.0	
3166603	Tamang, David Lee Acetylon Pharmaceuticals, Inc.	06/07/2015	3166603	15818585.0	
3167130	Fidlock GmbH	25/06/2015	3167130	15741503.5	German
3167509	Nokia Technologies Oy	02/07/2015	3167509	15741580.3	
3167510	Google LLC	15/05/2015	3167510	15819440.7	

3167587	Cisco Technology, Inc.	23/06/2015	3167587	15738191.4	
3167596	Cisco Technology, Inc.	23/06/2015	3167596	15738185.6	
3168131	Modec Inc.	25/09/2014	3168131	14897312.6	
3168651	FEI Company	09/11/2016	3168651	16198005.7	
3169238	Imaginalis S.r.l.	10/07/2015	3169238	15753463.7	
3169587	The SkyLIFE Company, Inc.	16/07/2015	3169587	15821467.6	
3169780	Qiagen GmbH	17/07/2015	3169780	15742208.0	
3171040	Howa Corporation	12/02/2015	3171040	15821636.6	
3171083	Host Holding B.V.	21/11/2016	3171083	16199856.2	
3171718	Nicoventures Holdings Limited	17/07/2015	3171718	15741289.1	
3172043	Compagnie Générale des Etablissements Michelin	10/07/2015	3172043	15753390.2	French
3172061	Compagnie Générale des Etablissements Michelin	09/07/2015	3172061	15736826.7	French
3172494	Weiss Klimatechnik GmbH	09/07/2015	3172494	15738036.1	German
3172840	Honeywell International Inc.	13/07/2015	3172840	15824936.7	
3172992	art & day GmbH	30/09/2016	3172992	16401067.0	German
3173477	BASF AGRICULTURAL SOLUTIONS SEED US LLC	13/09/2013	3173477	16205878.8	
3173699	ROBERT BOSCH GMBH	12/10/2016	3173699	16193484.9	German
3174451	F.HOFFMANN-LA ROCHE AG	28/07/2015	3174451	15741231.3	
3174806	Tiense Suikerraffinaderij N.V.	29/07/2015	3174806	15745153.5	
3174897	F.HOFFMANN-LA ROCHE AG	29/07/2015	3174897	15750278.2	
3175047	Caterpillar Inc.	10/07/2015	3175047	15739490.9	
3175050	Caterpillar Inc.	13/07/2015	3175050	15739493.3	
3175136	Chassis Brakes International B.V.	20/07/2015	3175136	15753724.2	French
3175162	Kutting UK Limited	13/07/2015	3175162	15750446.5	
3175195	Mahle International GmbH	24/07/2015	3175195	15742244.5	German
3175298	HP Indigo B.V.	31/07/2014	3175298	14748166.7	
3175305	Sew-Eurodrive GmbH & Co. KG	09/07/2015	3175305	15737982.7	German
3175438	Vascular Simulations, LLC	31/07/2015	3175438	15751196.5	
3175459	Hewlett-Packard Development Company, L.P.	30/07/2014	3175459	14898561.7	
3175797	Bioventrix, Inc.	28/09/2012	3175797	16206824.1	
3176111	BEUMER Group GmbH & Co. KG	04/12/2015	3176111	15003458.5	German
3176622	Nikon Corporation	30/07/2015	3176622	15826959.7	
3177095	QUALCOMM Incorporated	16/08/2009	3177095	16195494.6	

3177098	Huizhou TCL Mobile Communication Co., Ltd.	27/03/2015	3177098	15801107.2	
3177453	voxeljet AG	06/08/2015	3177453	15770785.2	German
3177971	Toyo System Co., Ltd.	08/08/2014	3177971	14899488.2	
3178437	Tidi Products, LLC	08/04/2009	3178437	17150799.9	
3178538	Mercury Capture Intellectual Property, LLC	18/08/2011	3178538	17150180.2	
3178750	Suzhou Pica Aluminum Industry Ltd.	19/12/2014	3178750	14899503.8	
3179049	General Electric Company	30/11/2016	3179049	16201568.9	
3179050	General Electric Company	30/11/2016	3179050	16201569.7	
3179051	General Electric Company	30/11/2016	3179051	16201570.5	
3179122	NTN Corporation	26/05/2009	3179122	17153050.4	
3179250	The University of Tokyo	06/08/2015	3179250	15829574.1	
3179312	Canon Kabushiki Kaisha	01/12/2016	3179312	16201625.7	
3179638	SICK AG	11/11/2016	3179638	16198312.7	German
3179687	Huawei Technologies Co., Ltd.	25/08/2014	3179687	14900441.8	
3179766	Innovative Technology Lab Co., Ltd.	06/08/2015	3179766	15829540.2	
3179797	Huawei Technologies Co., Ltd.	05/09/2014	3179797	14901374.0	
3179798	NTT DOCOMO, INC.	05/08/2015	3179798	15828940.5	
3179826	Samsung Electronics Co., Ltd.	08/12/2016	3179826	16202994.6	
3180055	Sulzer Mixpac AG	09/10/2015	3180055	15778655.9	
3180603	Koninklijke Philips N.V.	04/08/2015	3180603	15744252.6	
3180670	Intel Corporation	26/06/2015	3180670	15832084.6	
3180710	C 3 Limited	13/08/2015	3180710	15832255.2	
3180862	Google Technology Holdings LLC	06/08/2015	3180862	15751233.6	
3181050	Episurf IP Management AB	18/12/2015	3181050	15201361.1	
3181062	Covidien LP	13/12/2016	3181062	16203836.8	
3181381	Continental Reifen Deutschland GmbH	15/09/2016	3181381	16188865.6	German
3181459	Goodrich Lighting Systems GmbH	17/12/2015	3181459	15200651.6	
3181634	Continental Reifen Deutschland GmbH	21/11/2016	3181634	16199721.8	German
3181828	United Technologies Corporation	19/12/2016	3181828	16205180.9	
3181935	Foundation Brakes France	15/12/2016	3181935	16204476.2	French
3181979	Lethe GmbH	19/12/2016	3181979	16205165.0	German
3182061	General Electric Company	15/12/2016	3182061	16204247.7	
3182749	HUAWEI TECHNOLOGIES CO., LTD.	11/09/2014	3182749	14901700.6	

3183268	Novartis AG The Trustees Of The University Of Pennsylvania	19/08/2015	3183268	15756525.0	
3183391	Russell, Atlas James	14/08/2015	3183391	15753860.4	
3183582	Montana State University The United States of America, as represented by The Secretary, Department of Health and Human Services	17/08/2015	3183582	15757081.3	
3183603	IdentiFlight International, LLC	19/08/2015	3183603	15834027.3	
3184375	Volvo Car Corporation	22/12/2015	3184375	15201800.8	
3184377	Volvo Car Corporation	22/12/2015	3184377	15201802.4	
3184862	Volvo Car Corporation	23/12/2015	3184862	15202309.9	
3184932	Zhongying Changjiang International New Energy Investment Co., Ltd	30/06/2015	3184932	15833730.3	
3184978	Electrolux Appliances Aktiebolag	22/12/2015	3184978	15201804.0	
3185172	Dassault Systèmes	24/12/2015	3185172	15307146.9	
3185363	Heraeus Deutschland GmbH & Co. KG	23/12/2015	3185363	15202412.1	
3185428	Sony Semiconductor Solutions Corporation	11/08/2015	3185428	15834034.9	
3185534	ROBERT BOSCH GMBH	23/12/2015	3185534	15202263.8	
3185614	Fujitsu Limited	20/08/2014	3185614	14900305.5	
3185880	Ohio State Innovation Foundation	27/08/2015	3185880	15835788.9	
3185892	Proteo Biotech AG	24/08/2015	3185892	15756141.6	
3186116	Belanger, Inc.	28/08/2015	3186116	15759612.3	
3186198	Rohm and Haas Company Dow Global Technologies LLC	21/08/2015	3186198	15757612.5	
3186294	Renfortech Université de Montpellier Centre National de la Recherche Scientifique	20/08/2015	3186294	15759684.2	French
3186713	Advanced Micro Devices, Inc. ATI Technologies ULC	25/08/2015	3186713	15836943.9	
3187041	Technologies Holdings Corporation	07/06/2011	3187041	17151199.1	
3187353	Dana Automotive Systems Group, LLC	22/12/2016	3187353	16206482.8	
3187589	Genethon	05/08/2010	3187589	16205440.7	
3187645	Electrolux Appliances Aktiebolag	29/12/2015	3187645	15202861.9	

3187699	General Electric Company	14/12/2016	3187699	16204159.4	
3187787	Guillot Industrie	26/12/2016	3187787	16206905.8	French
3188260	The Board Of Trustees Of The University Of Illinois Dow Global Technologies Llc Rohm and Haas Electronic Materials LLC	21/12/2016	3188260	16206031.3	
3188296	Electro Power Systems Manufacturing S.r.L.	28/12/2016	3188296	16207072.6	
3188336	Sungrow Power Supply Co., Ltd.	08/05/2015	3188336	15836712.8	
3188713	perora GmbH	11/08/2015	3188713	15756376.8	
3188890	Windmüller & Hölscher KG	02/09/2015	3188890	15757492.2	German
3189108	STAEDTLER Mars GmbH & Co. KG	29/08/2015	3189108	15766748.6	German
3189184	Arçelik Anonim Sirketi	25/06/2015	3189184	15731348.7	
3189647	Honeywell International Inc.	25/08/2015	3189647	15838669.8	
3189758	Samsung Electronics Co., Ltd.	24/08/2015	3189758	15838500.5	
3190397	Horiba, Ltd.	21/08/2015	3190397	15837808.3	
3190760	LG Electronics Inc.	02/09/2015	3190760	15838010.5	
3191072	MAPA GmbH	11/09/2015	3191072	15760483.6	German
3191074	The Procter & Gamble Company	11/09/2015	3191074	15766725.4	
3191180	Medtronic Inc.	28/07/2015	3191180	15747341.4	
3191423	Pilkington Group Limited	09/09/2015	3191423	15766200.8	
3191723	Gripple Limited	09/09/2015	3191723	15778996.7	
3192013	IDEMIA France	10/09/2015	3192013	15771682.0	French
3193520	Sony Corporation	21/07/2015	3193520	15840159.6	
3193549	LG Electronics Inc.	14/09/2015	3193549	15839479.1	
3193979	SANOFI	11/09/2015	3193979	15760489.3	
3194049	Oxicool Inc.	24/08/2015	3194049	15835712.9	
3194312	Unitec S.p.A.	06/08/2015	3194312	15759545.5	
3194540	The Procter & Gamble Company	05/08/2015	3194540	15842276.6	
3194626	Helixbind Inc.	17/09/2015	3194626	15842027.3	
3194787	Atlas Copco Airpower, Naamloze Vennootschap	17/09/2015	3194787	15801982.8	
3194870	Polyplastic Groep B.V.	26/08/2015	3194870	15788231.7	
3195623	GEMALTO M2M GmbH	01/09/2015	3195623	15759725.3	
3195928	National Institute of Advanced Industrial Science and Technology	21/08/2015	3195928	15836482.8	

3196025	Kyocera Corporation	27/08/2015	3196025	15835383.9	
3197040	Sony Corporation	25/06/2015	3197040	15835185.8	
3197076	Canon Kabushiki Kaisha	28/12/2016	3197076	16207045.2	
3197154	Sony Interactive Entertainment Inc.	21/04/2010	3197154	17161317.7	
3197189	Canon Kabushiki Kaisha	15/12/2016	3197189	16204219.6	
3197571	Intel Corporation	25/08/2015	3197571	15844500.7	
3197668	Hewlett-Packard Development Company, L.P.	26/09/2014	3197668	14902605.6	
3197900	MDS R&D (China) Co., Ltd. Merck Sharp & Dohme Corp.	23/09/2015	3197900	15843683.2	
3198170	Getrag Ford Transmissions GmbH	24/09/2015	3198170	15771074.0	German
3198263	Bogazici Universitesi	14/09/2015	3198263	15782099.4	
3198348	Quantum Valley Investment Fund LP	23/09/2015	3198348	15844306.9	
3198708	TM4 Inc.	16/09/2015	3198708	15843266.6	
3199020	Technologies Holdings Corporation	07/06/2011	3199020	17151210.6	
3199309	Beiersdorf Aktiengesellschaft	15/11/2016	3199309	16198857.1	
3199714	Neoperl GmbH	29/12/2015	3199714	17000262.0	German
3200312	LG Chem, Ltd.	24/02/2016	3200312	16755880.8	
3200351	Sanechips Technology Co., Ltd.	14/04/2015	3200351	15851031.3	
3200842	UNIVERSITE CLERMONT AUVERGNE Centre National de la Recherche Scientifique	28/09/2015	3200842	15779024.7	French
3200968	S.I.P.A. Società Industrializzazione Progettazione e Automazione S.p.A.	01/10/2015	3200968	15797406.4	
3201149	Corning Incorporated	01/10/2015	3201149	15845659.0	
3201361	Chronix Biomedical	30/09/2015	3201361	15848055.8	
3201627	Rite Taste, LLC	02/10/2015	3201627	15846637.5	
3201661	Chromator GmbH	29/09/2015	3201661	15793675.8	German
3201700	Microsoft Technology Licensing, LLC	29/09/2015	3201700	15782133.1	
3202010	Humavox Ltd.	06/10/2015	3202010	15847999.8	
3202342	Fujifilm Corporation	29/09/2015	3202342	15845597.2	
3202450	Babybe GmbH	03/05/2013	3202450	17160702.1	German
3202903	President and Fellows of Harvard College	22/12/2011	3202903	17160955.5	
3203151	ROBERT BOSCH GMBH	01/12/2016	3203151	16201672.9	German
3203665	Kabushiki Kaisha Toshiba	16/09/2015	3203665	15845834.9	

3204520	Cornell University	08/10/2015	3204520	15849301.5	
3204536	Wayne State University	12/10/2015	3204536	15849578.8	
3204553	Ecolab USA Inc.	05/10/2015	3204553	15848358.6	
3204728	Robert Bosch GmbH	29/09/2015	3204728	15778896.9	German
3205036	QUALCOMM Incorporated	02/10/2015	3205036	15779160.9	
3205518	Hübner GmbH & Co. KG	22/12/2016	3205518	16206197.2	German
3205694	Sumitomo Seika Chemicals Co. Ltd.	07/10/2015	3205694	15849684.4	
3207283	Ashmin Holding LLC	01/10/2015	3207283	15850474.6	
3207496	Microsoft Technology Licensing, LLC	07/10/2015	3207496	15784841.7	
3207683	Siemens Mobility GmbH	10/12/2015	3207683	15817777.4	German
3207811	Japan Tobacco Inc.	04/11/2015	3207811	15858446.6	
3208340	versalis S.p.A.	22/02/2016	3208340	16425016.9	
3208595	CRRC Xi'An Yongejietong Electric Co., Ltd.	30/12/2015	3208595	15858117.3	
3208608	General Electric Company	13/02/2017	3208608	17155845.5	
3208966	Analog Devices Global Unlimited Company	15/02/2017	3208966	17156381.0	
3209013	Samsung Electronics Co., Ltd.	15/02/2017	3209013	17156205.1	
3209020	Samsung Electronics Co., Ltd.	21/05/2015	3209020	15857097.8	
3209149	Philip Morris Products S.A.	15/10/2015	3209149	15791759.2	
3209280	Henkel AG & Co. KGaA	18/09/2015	3209280	15763943.6	German
3209621	Corning Incorporated	22/10/2015	3209621	15793958.8	
3209879	Robert Bosch GmbH	12/10/2015	3209879	15781621.6	German
3209904	Audi AG	14/10/2015	3209904	15781027.6	German
3210314	Telefonaktiebolaget LM Ericsson (publ)	24/10/2014	3210314	14799903.1	
3210356	Qualcomm Incorporated	24/09/2015	3210356	15778122.0	
3210385	Cisco Technology, Inc.	12/10/2015	3210385	15787088.2	
3210457	CNH Industrial Belgium nv	23/02/2017	3210457	17157544.2	
3210461	CLAAS Selbstfahrende Erntemaschinen GmbH	07/12/2016	3210461	16202645.4	German
3210462	Yamabiko Corporation	20/02/2017	3210462	17156913.0	
3210803	Hübner GmbH & Co. KG	29/02/2016	3210803	16157874.5	German
3210960	China Petroleum & Chemical Corporation Research Institute Of Petroleum ProcessingSinopec	20/10/2015	3210960	15852702.8	
3211041	Namics Corporation	22/10/2015	3211041	15851902.5	

3211363	Brose Fahrzeugteile GmbH & Co. Kommanditgesellschaft, Bamberg	18/12/2012	3211363	17161057.9	German
3211627	Crambo, S.A. García Manchado, Miguel Ángel	26/10/2015	3211627	15853097.2	
3211941	China Academy of Telecommunications Technology	12/10/2015	3211941	15851849.8	
3212188	King Abdullah University of Science and Technology	29/10/2015	3212188	15821156.5	
3212631	F.HOFFMANN-LA ROCHE AG	28/10/2015	3212631	15785139.5	
3213062	Children's Medical Center Corporation	29/10/2015	3213062	15856119.1	
3213417	Sony Corporation	12/11/2015	3213417	15797154.0	
3213599	Hung, Yuen Sum, Ho Man	22/10/2015	3213599	15854826.3	
3213639	Cj Cheiljedang Corporation	02/07/2015	3213639	15854505.3	
3213926	SK Chemicals Co., Ltd.	29/10/2015	3213926	15855249.7	
3214002	Toyo Jidoki Co., Ltd.	27/02/2017	3214002	17158070.7	
3214582	PROTON WORLD INTERNATIONAL N.V.	27/07/2016	3214582	16181366.2	French
3214915	Väderstad Holding AB	05/11/2015	3214915	15820322.4	
3215065	Cossington Limited	05/11/2015	3215065	15828777.1	
3215206	S.A.S.C. AG	11/09/2015	3215206	15777614.7	German
3215692	Etablissements Pierre Gréhal et Cie SA	02/10/2015	3215692	15788143.4	French
3215839	Ecolab USA Inc.	28/10/2015	3215839	15857277.6	
3216277	University of Surrey	03/11/2015	3216277	15794240.0	
3217243	Simmonds Precision Products, Inc.	09/03/2017	3217243	17160167.7	
3217751	ZTE Corporation	30/04/2015	3217751	15857182.8	
3217754	ASUSTek Computer Inc.	09/03/2017	3217754	17160150.3	
3217850	Bowens, Gerard Bowens, Sean	10/11/2015	3217850	15791310.4	
3218523	Liquid Genomics, Inc.	13/11/2015	3218523	15859714.6	
3218661	Project Pharmaceuticals GmbH	12/11/2015	3218661	15800982.9	
3218924	Femtometrix, Inc.	12/11/2015	3218924	15858539.8	
3219180	Siemens Aktiengesellschaft	17/11/2015	3219180	15797067.4	German
3219610	The Boeing Company	06/03/2017	3219610	17159453.4	
3220124	Omron Corporation	21/12/2016	3220124	16205605.5	
3220516	NSK Ltd.	15/12/2015	3220516	15869964.5	

3220590	AutoNetworks Technologies, Ltd. Sumitomo Wiring Systems, Ltd. Sumitomo Electric Industries, Ltd. TOYOTA JIDOSHA KABUSHIKI KAISHA	06/11/2015	3220590	15859949.8	
3220602	Beijing Xiaomi Mobile Software Co., Ltd.	16/03/2017	3220602	17161297.1	
3220833	Laboratory Corporation of America Holdings	19/11/2015	3220833	15861257.2	
3220835	Joseph, Lalu	12/11/2015	3220835	15861758.9	
3221513	Lahtonen, Kari O.	17/11/2015	3221513	15817928.3	
3222055	PS Audio Design Oy	18/11/2015	3222055	15801194.0	
3222356	Alfa Wassermann, Inc.	19/12/2008	3222356	17166638.1	
3222410	Evonik Operations GmbH	17/03/2017	3222410	17161624.6	German
3222596	Dai Nippon Printing Co., Ltd.	17/11/2015	3222596	15861944.5	
3222857	United Technologies Corporation	21/03/2017	3222857	17162009.9	
3223240	Imagination Technologies Limited	20/03/2017	3223240	17161835.8	
3223546	Huawei Technologies Co., Ltd.	21/11/2014	3223546	14906324.0	
3224383	Quest Diagnostics Investments Incorporated	24/11/2015	3224383	15863931.0	
3224615	University Court of The University of St Andrews	09/11/2015	3224615	15794269.9	
3224917	OSRAM Opto Semiconductors GmbH	19/11/2015	3224917	15797665.5	German
3225049	Telefonaktiebolaget LM Ericsson (publ)	27/11/2014	3225049	14906834.8	
3225251	H. Lundbeck A/S	21/12/2007	3225251	17150769.2	
3225456	Aisin Seiki Kabushiki Kaisha Chiba Institute of Technology	26/11/2015	3225456	15862595.4	
3226179	Kabushiki Kaisha Toshiba	26/11/2014	3226179	14906926.2	
3226828	Dow Global Technologies LLC Rohm and Haas Company	02/12/2014	3226828	14907501.2	
3226986	Bellasilky Investments Pty Ltd	04/12/2015	3226986	15864652.1	
3227073	Robert Bosch GmbH	01/12/2015	3227073	15866082.9	
3227444	Novozymes A/S	03/12/2015	3227444	15804776.1	
3227522	Aarbakke Innovation A.S.	10/11/2015	3227522	15860234.2	
3227813	Biomerieux Hospices Civils De Lyon	30/11/2015	3227813	15808766.8	French
3228132	Microsoft Technology Licensing, LLC	28/11/2015	3228132	15813966.7	

3228198	Joyetech (Changzhou) Electronics Co., Ltd.	20/08/2015	3228198	15867132.1	
3228377	Mi, Min Sun, Funan Lv, Wei Beijing Institute of Spacecraft System Engineering Miao, Jianyin Zhang, Hongxing	28/12/2015	3228377	15865310.5	
3228764	Hamat Sanitary Fitting And Casting	30/03/2017	3228764	17164029.5	
3228869	Exel Industries	03/04/2017	3228869	17164631.8	French
3229242	Siemens Aktiengesellschaft	07/03/2017	3229242	17159504.4	German
3229342	Mitsubishi Electric Engineering Company Limited	05/12/2014	3229342	14907585.5	
3229699	Koninklijke Philips N.V.	01/12/2015	3229699	15816525.8	
3229766	BASF SE	09/12/2015	3229766	15807888.1	
3229867	SANOFI	08/12/2015	3229867	15805211.8	
3229873	SANOFI	08/12/2015	3229873	15805225.8	
3229895	Koninklijke Philips N.V.	09/12/2015	3229895	15805535.0	
3229898	Koninklijke Philips N.V.	07/12/2015	3229898	15820619.3	
3230200	Robert Bosch GmbH	10/12/2015	3230200	15866598.4	
3230531	Kettner, Maik	11/12/2015	3230531	15825602.4	German
3230924	Fingerprint Cards AB	09/12/2015	3230924	15867305.3	
3231104	Intelsat US LLC	10/12/2015	3231104	15868298.9	
3231162	Cisco Technology, Inc.	25/11/2015	3231162	15866380.7	
3232018	United Technologies Corporation	11/04/2017	3232018	17166102.8	
3232044	Coquis Sánchez-Concha, Rodrigo	25/11/2016	3232044	16882175.9	
3232077	Isuzu Motors Limited	11/12/2015	3232077	15866493.8	
3232083	TERAFORCE Precision Technology Co., Ltd.	07/04/2017	3232083	17165603.6	
3233169	Koninklijke Philips N.V.	10/12/2015	3233169	15820624.3	
3233218	Angehrn AG Umformtechnik	15/12/2015	3233218	15817152.0	German
3233245	Koninklijke Philips N.V.	16/12/2015	3233245	15813361.1	
3233367	SAFRAN AIRCRAFT ENGINES	16/12/2015	3233367	15821141.7	French
3233455	Compagnie Générale des Etablissements Michelin	08/12/2015	3233455	15870704.2	

3233881	The Trustees of Columbia University in the City of New York	18/12/2015	3233881	15871195.2	
3234037	OCE-TECHNOLOGIES B.V.	10/12/2015	3234037	15808174.5	
3234183	F. Hoffmann-La Roche AG	18/12/2015	3234183	15816759.3	
3234321	Typhon Technology Solutions, LLC	16/12/2015	3234321	15870991.5	
3234324	TOYOTA JIDOSHA KABUSHIKI KAISHA	10/11/2015	3234324	15804236.6	
3234362	Qonqave GmbH	17/12/2015	3234362	15823148.0	German
3234495	Thieme, Ringo	21/12/2015	3234495	15823156.3	German
3234725	Ecolab USA Inc.	09/12/2015	3234725	15870712.5	
3235377	Unicharm Corporation	09/03/2015	3235377	15883982.9	
3235792	ARKEMA B.V.	18/04/2016	3235792	16165857.0	
3235795	Rolls-Royce plc Rolls-Royce Corporation	21/04/2017	3235795	17167612.5	
3235800	Mitsubishi Chemical Corporation	17/12/2015	3235800	15870065.8	
3235816	Shanghai Haiyan Pharmaceutical Technology Co., Ltd. Yangtze River Pharmaceutical Group Co., Ltd.	17/12/2015	3235816	15869340.8	
3235850	Samyang Corporation	18/12/2015	3235850	15870352.0	
3235910	MD Healthcare Inc.	10/12/2015	3235910	15870243.1	
3235959	HITACHI CONSTRUCTION MACHINERY TIERRA CO., LTD.	30/10/2015	3235959	15869670.8	
3236124	Rubicon Research Pty Ltd.	30/03/2012	3236124	17168709.8	
3236918	L'OREAL	23/12/2015	3236918	15813892.5	
3237030	Smith & Nephew plc	21/12/2015	3237030	15828850.6	
3237049	Koninklijke Philips N.V.	17/12/2015	3237049	15823793.3	
3237211	Koenig & Bauer AG	09/12/2015	3237211	15805544.2	German
3237253	Roadtec, Inc.	18/12/2015	3237253	15874207.2	
3237368	Purac Biochem bv	22/12/2015	3237368	15817372.4	
3237544	Rhodia Operations	21/12/2015	3237544	15820513.8	French
3237615	The Broad Institute, Inc. Massachusetts Institute of Technology President and Fellows of Harvard College	21/12/2015	3237615	15831022.7	
3237654	Koninklijke Philips N.V.	11/12/2015	3237654	15808567.0	
3237769	Robert Bosch GmbH	08/12/2015	3237769	15807858.4	German

3237809	Koninklijke Philips N.V.	21/12/2015	3237809	15817326.0	
3237865	Haydale Graphene Industries plc	23/12/2015	3237865	15837223.5	
3237894	Arcelormittal	23/12/2015	3237894	15825860.8	French
3237952	Amazon Technologies, Inc.	22/12/2015	3237952	15823508.5	
3238328	Audi AG	19/12/2015	3238328	15819790.5	German
3238558	HJC Corp.	30/05/2016	3238558	16171960.4	
3238652	3Shape A/S	27/04/2017	3238652	17168316.2	
3239005	Nippon Vinylon Co., Ltd.	14/12/2015	3239005	15872778.4	
3239063	JB Medical, Inc.	23/12/2015	3239063	15871415.4	
3239182	Kuraray Co., Ltd.	22/12/2015	3239182	15873041.6	
3239267	AGC Inc.	18/05/2012	3239267	17000964.1	
3239268	AGC Inc.	18/05/2012	3239268	17000965.8	
3239457	FMC Technologies Do Brasil LTDA	23/12/2014	3239457	14908653.0	
3239491	Kabushiki Kaisha Kobe Seiko Sho (Kobe Steel, Ltd.)	14/12/2015	3239491	15872791.7	
3239518	Moffat, Brian Lee	27/03/2009	3239518	17169133.0	
3239565	Tirsan Treyler Sanayi Ve Ticaret Anonim Sirketi	06/04/2017	3239565	17165222.5	
3240382	TE Connectivity Industrial GmbH	10/04/2017	3240382	17165680.4	German
3240531	Charité - Universitätsmedizin Berlin	28/12/2015	3240531	15837208.6	German
3240588	Smith & Nephew plc	21/12/2015	3240588	15813852.9	
3240659	The Gillette Company LLC	09/12/2015	3240659	15823562.2	
3240798	Navya Biologicals Pvt. Ltd.	01/01/2016	3240798	16732884.8	
3240971	Siemens Aktiengesellschaft	14/10/2015	3240971	15780852.8	
3241117	Emerico International SDN BHD	27/11/2015	3241117	15825869.9	
3241316	BULL SAS	03/12/2015	3241316	15817961.4	French
3241467	Vorwerk & Co. Interholding GmbH	12/10/2015	3241467	17170775.5	German
3241754	Unison Industries LLC	25/04/2017	3241754	17168054.9	
3242074	LG Innotek Co., Ltd.	29/12/2015	3242074	15875664.3	
3242132	Ascendant Diagnostics, LLC	05/05/2016	3242132	16168524.3	
3242298	Eksorb Ltd.	12/11/2015	3242298	15875780.7	
3242609	Strait Access Technologies Holdings (PTY) LTD	18/12/2015	3242609	15825960.6	
3243500	Ricoh Company, Ltd.	23/03/2017	3243500	17162627.8	
3244040	United Technologies Corporation	10/05/2017	3244040	17170487.7	
3244175	Palo Alto Research Center Incorporated	05/05/2017	3244175	17169726.1	
3244986	Solvay SA	22/12/2015	3244986	15820148.3	

3245154	Travel Caddy, Inc.	13/01/2016	3245154	16737817.3	
3246488	Clement, Michael	03/05/2017	3246488	17169185.0	German
3246986	Murata Manufacturing Co., Ltd.	11/12/2015	3246986	15877754.0	
3247320	Suma Care ApS	02/12/2015	3247320	15804310.9	
3248231	Itron Global SARL	18/12/2015	3248231	15823503.6	
3248439	Qualcomm Incorporated	18/12/2015	3248439	15826237.8	
3248820	Grupo Antolin Ingenieria, S.A.U.	27/05/2016	3248820	16382238.0	
3249149	Pica Corp.	31/08/2016	3249149	16841896.0	
3249256	Kyowa Metal Works Co., Ltd	22/05/2017	3249256	17172305.9	
3249791	The Switch Drive Systems Oy	31/03/2016	3249791	17176530.8	
3249841	China Mobile Communications Corporation	21/12/2015	3249841	15881852.6	
3249847	Telefonaktiebolaget LM Ericsson (publ)	30/04/2008	3249847	17182173.9	
3250811	Delphi Technologies IP Limited	02/12/2015	3250811	15804124.4	
3251513	Kuchenmeister GmbH	16/05/2017	3251513	17171298.7	German
3251857	Hitachi Industrial Equipment Systems Co., Ltd.	31/05/2017	3251857	17000928.6	
3252247	Fentech AG	01/06/2016	3252247	16172490.1	German
3252269	Halliburton Energy Services Inc.	07/11/2011	3252269	17176282.6	
3252345	JTEKT CORPORATION	26/05/2017	3252345	17173086.4	
3252638	Beijing Xiaomi Mobile Software Co., Ltd.	28/03/2017	3252638	17163439.7	
3252778	The Boeing Company	16/03/2017	3252778	17161457.1	
3253123	Alcatel Lucent	31/05/2016	3253123	16290096.3	
3253525	Illinois Tool Works Inc.	15/12/2015	3253525	15817736.0	
3255330	Hauff-Technik GmbH & Co. KG	09/06/2016	3255330	16020226.3	German
3255445	Aichi Steel Corporation	23/02/2016	3255445	16761476.7	
3256268	Solystic	16/12/2015	3256268	15821146.6	French
3256578	CNAM Conservatoire National des Arts des Metiers INSERM - Institut National de la Santé et de la Recherche Médicale Centre National de la Recherche Scientifique (C.N.R.S.) Université Paris Diderot - Paris 7 Commissariat à l'Energie Atomique et aux Energies Alternatives	12/02/2016	3256578	16704213.4	

3256683	Strada Design Limited	16/11/2015	3256683	15859310.3	
3257952	Life Technologies Corporation	10/09/2013	3257952	17178012.5	
3258172	Rinnai Corporation	26/05/2017	3258172	17173074.0	
3258344	Hand Held Products, Inc.	13/06/2017	3258344	17175786.7	
3258570	LG Chem, Ltd.	15/06/2017	3258570	17176180.2	
3258730	Huawei Device Co., Ltd.	31/07/2012	3258730	17157286.0	
3259043	Boll & Kirch Filterbau GmbH	17/02/2016	3259043	16709821.9	
3259221	Schwing GmbH	19/02/2016	3259221	16708951.5	German
3259531	Intergas Heating Assets B.V.	22/02/2016	3259531	16714578.8	
3259564	TI Group Automotive Systems, LLC	18/02/2016	3259564	16708297.3	
3259897	Roku, Inc.	22/02/2016	3259897	16753218.3	
3259960	Honeywell International Inc.	20/02/2015	3259960	15882857.4	
3260355	NSK Ltd.	08/03/2017	3260355	17763310.4	
3260537	BASF SE	13/12/2011	3260537	17179938.0	German
3260915	HUAWEI TECHNOLOGIES CO., LTD.	25/05/2015	3260915	15892853.1	
3261308	Sanechips Technology Co., Ltd.	29/12/2015	3261308	15882481.3	
3261389	Honeywell International Inc.	15/06/2017	3261389	17176284.2	
3261826	Printed Structures Limited	29/02/2016	3261826	16707555.5	
3261956	Philip Morris Products S.A.	24/02/2016	3261956	16705974.0	
3262037	ABIVAX CNRS Centre National de la Recherche Scientifique Institut Curie Université de Montpellier	19/02/2016	3262037	16705515.1	
3262076	Fondazione IRCCS Istituto Nazionale dei Tumori	26/02/2016	3262076	16712218.3	
3262164	Carbios	24/02/2016	3262164	16707039.0	
3263213	Nippon Kayaku Kabushiki Kaisha	25/02/2016	3263213	16755626.5	
3263610	Kuraray Co., Ltd.	26/02/2016	3263610	16755674.5	
3263801	Storch Malerwerkzeuge & Profigeräte GmbH	19/05/2017	3263801	17020221.2	German
3264244	Samsung Display Co., Ltd.	30/06/2017	3264244	17178904.3	
3264832	Intel IP Corporation	30/06/2016	3264832	16177061.5	
3264883	E-Smarts Global Licensing Ltd	24/04/2015	3264883	15866387.2	
3265255	BASF SE	03/03/2016	3265255	16707771.8	
3265343	Virgilio, Savino	04/03/2016	3265343	16718456.3	

3265421	SodaStream Industries Ltd.	02/03/2016	3265421	16758530.6	
3265535	Prestone Products Corporation	04/03/2016	3265535	16759559.4	
3265818	Micromass UK Limited	07/03/2016	3265818	16710785.3	
3266549	Bolzenschweißtechnik Heinz Soyer GmbH	05/07/2017	3266549	17179698.0	German
3266633	RENAULT s.a.s.	04/07/2017	3266633	17179641.0	French
3266781	Hodogaya Chemical Co., Ltd.	10/11/2010	3266781	17001098.7	
3267417	Hitachi Construction Machinery Co., Ltd.	03/03/2015	3267417	15883925.8	
3267553	Delta Electronics, Inc.	03/04/2017	3267553	17164475.0	
3267574	Black & Decker Inc.	06/07/2017	3267574	17179964.6	
3267596	Omron Corporation	01/03/2016	3267596	16761561.6	
3267781	FUJI Corporation	06/03/2015	3267781	15884487.8	
3267963	Kettenbach GmbH & CO. KG	04/03/2016	3267963	16707818.7	German
3268008	VIRBAC	11/03/2016	3268008	16714537.4	French
3268095	Rottfella AS	04/03/2016	3268095	16723186.9	
3268187	Robert Bosch GmbH	10/03/2016	3268187	16762503.7	
3268574	Hunting Titan Inc.	11/03/2016	3268574	16762685.2	
3269086	Telefonaktiebolaget LM Ericsson (PUBL)	13/03/2015	3269086	15885691.4	
3269439	Filtration Group GmbH	20/06/2017	3269439	17176905.2	German
3269552	Seiko Epson Corporation	10/07/2017	3269552	17180436.2	
3269929	Rolls-Royce North American Technologies, Inc.	14/06/2017	3269929	17175905.3	
3270236	MONTRES BREGUET S.A.	15/07/2016	3270236	16179617.2	French
3270272	Shenzhen Goodix Technology Co., Ltd.	31/05/2016	3270272	16892935.4	
3270479	MASCHINENBAU SCHOLZ GMBH & CO. KG	23/06/2017	3270479	17001075.5	German
3270775	Nuvo Group Ltd.	16/03/2016	3270775	16764295.8	
3271046	Siemens Aktiengesellschaft	07/03/2016	3271046	16710937.0	German
3271078	GEA Tuchenhagen GmbH	14/03/2016	3271078	16711187.1	German
3271106	Illinois Tool Works Inc.	11/03/2016	3271106	16710649.1	
3271116	Nexustec GmbH	16/03/2016	3271116	16712766.1	German

3271382	Max-Delbrück-Centrum für Molekulare Medizin in der Helmholtz- Gemeinschaft Helmholtz Zentrum München - Deutsches Forschungszentrum für Gesundheit und Umwelt (GmbH)	15/03/2016	3271382	16713750.4	
3271389	The United States of America, as Represented by the Secretary Department of Health and Human Services	18/03/2016	3271389	16716979.6	
3272154	QUALCOMM Incorporated	11/03/2016	3272154	16711491.7	
3272165	Telefonaktiebolaget LM Ericsson (PUBL)	18/03/2015	3272165	15716174.6	
3272343	Grünenthal GmbH	27/04/2012	3272343	17185830.1	
3272581	L'AIR LIQUIDE, Société Anonyme pour l'Etude et l'Exploitation des Procédés Georges Claude	21/07/2016	3272581	16180613.8	
3272953	Xiamen Axent Corporation Limited	15/03/2016	3272953	16764230.5	
3272975	dormakaba Schweiz AG	21/07/2017	3272975	17182576.3	German
3273042	Toyota Jidosha Kabushiki Kaisha	18/07/2017	3273042	17181856.0	
3273134	SKS metaplast Scheffer-Klute GmbH	20/09/2017	3273134	17192186.9	German
3273140	Chen, Kaipou	23/02/2016	3273140	16764153.9	
3273172	Gree Electric Appliances, Inc. of Zhuhai	21/08/2015	3273172	15885161.8	
3273450	Tesla Engineering Limited	30/09/2013	3273450	17170279.8	
3273917	Orthosoft ULC	23/03/2016	3273917	16767592.5	
3273948	Patheon Softgels Inc.	25/03/2016	3273948	16769742.4	
3275181	Microsoft Technology Licensing, LLC	27/04/2016	3275181	16721582.1	
3275705	MAN Truck & Bus SE	07/07/2017	3275705	17180294.5	German
3275728	ALSTOM Transport Technologies	24/07/2017	3275728	17182795.9	French
3275908	Nippon Shokubai Co., Ltd.	04/03/2016	3275908	16768353.1	
3275926	Asahi Kasei Construction Materials Corporation	23/03/2016	3275926	16768060.2	
3276365	Melexis Technologies SA	26/07/2016	3276365	16181344.9	
3276490	Cisco Technology, Inc.	18/07/2017	3276490	17181901.4	
3277502	3M Innovative Properties Company	01/04/2016	3277502	16774298.0	
3277503	3M Innovative Properties Company	01/04/2016	3277503	16774302.0	

3277956	Arçelik Anonim Sirketi	31/03/2015	3277956	15717824.5	
3278139	Microwave Characterization Center	25/03/2016	3278139	16717986.0	French
3278433	Monza, Thomas Rebosio, Riccardo Molteni, Giacomo	31/03/2016	3278433	16721232.3	
3278469	Samsung Electronics Co., Ltd.	01/04/2016	3278469	16773489.6	
3278506	Telefonaktiebolaget LM Ericsson (publ)	01/04/2015	3278506	15714797.6	
3278722	Equos Research Co., Ltd.	30/03/2016	3278722	16773032.4	
3278783	Ferno-Washington, Inc.	19/07/2013	3278783	17189127.8	
3278944	Nichiban Co. Ltd.	18/12/2015	3278944	15887786.0	
3279091	Hamilton Sundstrand Corporation	02/08/2017	3279091	17184407.9	
3279215	MedImmune Limited	24/11/2010	3279215	17179204.7	
3279345	JX Nippon Mining & Metals Corporation	28/03/2016	3279345	16772758.5	
3279394	Nitta Corporation	30/03/2016	3279394	16773003.5	
3279528	SCC, Inc.	03/04/2017	3279528	17164660.7	
3279619	VEGA Grieshaber KG	01/08/2016	3279619	16182151.7	German
3280051	Japan Science and Technology Agency	24/03/2016	3280051	16772572.0	
3280242	Kuhn Huard S.A. Betek GmbH & Co. KG	04/04/2016	3280242	16713490.7	German
3280716	Bayer CropScience AG	05/04/2016	3280716	16714418.7	German
3280923	R B & W Manufacturing LLC	08/04/2016	3280923	16777375.3	
3281024	Gapwaves AB	04/04/2016	3281024	16776989.2	
3281082	Telefonaktiebolaget LM Ericsson (publ)	10/04/2015	3281082	15719631.2	
3281140	Microsoft Technology Licensing, LLC	04/04/2016	3281140	16715984.7	
3281272	Ossia Inc.	04/04/2016	3281272	16777118.7	
3281434	Telefonaktiebolaget LM Ericsson (publ)	08/04/2016	3281434	16715524.1	
3281658	Medtronic Inc.	10/08/2017	3281658	17185810.3	
3281947	The University of Chicago	05/04/2010	3281947	17193256.9	
3281950	Spiber Inc.	29/10/2012	3281950	17194459.8	
3282029	Nippon Steel Corporation	07/04/2016	3282029	16776633.6	
3282576	NSK Ltd.	05/04/2016	3282576	16776509.8	
3282586	Sick AG	25/07/2017	3282586	17182902.1	German
3282639	2IP Co., Ltd.	11/04/2016	3282639	16776939.7	
3282673	Huawei Technologies Co., Ltd.	01/04/2009	3282673	17188077.6	
3283097	Ferring B.V.	15/04/2016	3283097	16719315.0	

3283138	Johnson & Johnson Surgical Vision, Inc.	16/12/2015	3283138	15823070.6	
3283596	The Lubrizol Corporation	12/04/2016	3283596	16717796.3	
3283628	Wageningen Universiteit	15/04/2016	3283628	16716591.9	
3283698	Caterpillar Inc.	30/03/2016	3283698	16715735.3	
3283859	Micatu Inc.	15/04/2016	3283859	16780848.4	
3284224	Orange	15/04/2016	3284224	16723416.0	French
3284396	Leica Instruments (Singapore) Pte. Ltd.	16/08/2016	3284396	16184311.5	
3284497	Becton, Dickinson and Company	18/03/2013	3284497	17193217.1	
3284955	Hamilton Sundstrand Corporation	18/08/2016	3284955	16461552.8	
3284959	Monogram Aerospace Fasteners, Inc.	09/03/2017	3284959	17160089.3	
3285068	PHC Holdings Corporation	03/12/2004	3285068	17190588.8	
3285221	Jini Co. Ltd.	15/12/2016	3285221	16895733.0	
3285252	e.solutions GmbH	17/08/2016	3285252	16001812.3	
3285353	GUANGDONG OPPO MOBILE TELECOMMUNICATIONS CORP., LTD.	26/07/2016	3285353	16889008.5	
3285432	Huawei Technologies Co., Ltd.	30/07/2015	3285432	15899317.0	
3285623	Compagnie Méditerranéenne des Cafés	22/04/2016	3285623	16717958.9	French
3285915	United Technologies Corporation	24/04/2015	3285915	15890107.4	
3285951	IPG Laser GmbH Volkswagen Aktiengesellschaft	18/03/2016	3285951	16710454.6	German
3286064	Dorel France	07/04/2016	3286064	16717296.4	French
3286103	Hop Shing Metal & Plastic Manufactory Ltd.	27/11/2015	3286103	15889757.9	
3286457	Safran Aircraft Engines	21/04/2016	3286457	16725185.9	French
3286473	A. Raymond et Cie	19/04/2016	3286473	16721077.2	German
3287474	AGC Chemicals Europe, Limited AGC Inc.	25/03/2016	3287474	16782940.7	
3287934	Bastille Networks, Inc.	02/06/2015	3287934	17189631.9	
3288544	The University of Hong Kong	27/04/2016	3288544	16785923.0	
3288573	Psioxus Therapeutics Limited	29/04/2016	3288573	16723043.2	
3288616	Bing Innovations, LLC	29/04/2016	3288616	16789808.9	
3288783	Compagnie Générale des Etablissements Michelin	24/03/2016	3288783	16786884.3	
3288802	Dorel France	28/04/2016	3288802	16719854.8	French
3288888	Nemag B.V.	02/05/2016	3288888	16731379.0	

3288923	Bayer CropScience Aktiengesellschaft	28/04/2016	3288923	16721748.8	
3289092	Biofactura Inc. Momenta Pharmaceuticals, Inc.	27/04/2016	3289092	16787029.4	
3289169	Kinetic Pressure Control Limited	29/04/2016	3289169	16788951.8	
3289385	KATHREIN SE	26/04/2016	3289385	16718379.7	German
3290025	Sun Pharmaceutical Industries Ltd	01/09/2017	3290025	17189128.6	
3290114	Bio-Rad Europe GmbH	02/09/2016	3290114	16306109.6	
3290897	Safran Aero Boosters SA	01/09/2017	3290897	17188927.2	French
3291275	Seari Electric Technology Co., Ltd. Zhejiang Chint Electrics Co., Ltd.	22/04/2016	3291275	16785894.3	
3291361	Helmholtz-Zentrum Geesthacht Zentrum für Material- und Küstenforschung GmbH	02/09/2016	3291361	16187152.0	
3291401	NR Electric Co., Ltd. NR Electric Engineering Co., Ltd.	19/02/2016	3291401	16785743.2	
3291443	ams AG	01/09/2016	3291443	16186820.3	
3291515	GUANGDONG OPPO MOBILE TELECOMMUNICATIONS CORP., LTD.	29/08/2017	3291515	17188410.9	
3291620	Huawei Technologies Co., Ltd.	22/05/2015	3291620	15892836.6	
3291774	Bentley InnoMed GmbH	06/05/2016	3291774	16726017.3	German
3292020	HAZEMAG & EPR GmbH	04/05/2015	3292020	15725508.4	German
3292141	Eli Lilly and Company	28/04/2016	3292141	16721605.0	
3292281	Volvo Truck Corporation	06/05/2015	3292281	15722690.3	
3292854	KCI Licensing, Inc.	17/12/2009	3292854	17197927.1	
3292894	Brison S.A.	08/09/2016	3292894	16187935.8	French
3292925	Posco	26/08/2015	3292925	15891325.1	
3292975	Groß, Bernd	05/09/2017	3292975	17189308.4	German
3293123	Qingdao Haikejia Intelligent Equipment Technology Co., Ltd.	23/12/2016	3293123	16899290.7	
3293440	Bartenbach Holding GmbH	08/09/2017	3293440	17190128.3	German
3293816	Samsung Electronics Co., Ltd.	31/08/2017	3293816	17188722.7	
3294010	Sony Corporation	25/03/2016	3294010	16789478.1	
3294066	Sea6 Energy Pvt. Ltd.	09/05/2016	3294066	16792318.4	
3294532	Vestas Wind Systems A/S	11/05/2016	3294532	16725028.1	
3294533	Fill Gesellschaft m.b.H.	03/03/2016	3294533	16715991.2	German
3294788	Covestro LLC	10/05/2016	3294788	16723920.1	

3295260	Bucherer AG	04/05/2016	3295260	16723240.4	German
3295711	Sony Corporation	11/05/2016	3295711	16725395.4	
3295738	Telefonaktiebolaget LM Ericsson (publ)	20/04/2016	3295738	16719920.7	
3296207	Honeywell International Inc.	16/09/2016	3296207	16189339.1	
3296294	Jiangsu Atom Bioscience And Pharmaceutical Co., Ltd	06/05/2016	3296294	16792124.6	
3296302	Zhejiang Jiuzhou Pharmaceutical Co., Ltd.	26/01/2016	3296302	16795647.3	
3296449	Aqua Co., Ltd. Qingdao Haier Washing Machine Co., Ltd.	13/05/2016	3296449	16795858.6	
3296530	AISIN SEIKI KABUSHIKI KAISHA	14/09/2017	3296530	17191115.9	
3296535	Mahle International GmbH	14/09/2016	3296535	16188761.7	
3296711	DENSO CORPORATION	20/04/2016	3296711	16792502.3	
3297477	Schawbel Technologies LLC	17/05/2016	3297477	16725716.1	
3297836	Canadian Bank Note Company, Limited	20/05/2016	3297836	16795602.8	
3297949	Ecole Nationale Superieure de Chimie de Clermont Ferrand Centre National de la Recherche Scientifique Université Blaise Pascal - CLERMONT II Alma Mater Studiorum -Università di Bologna	19/05/2016	3297949	16729962.7	French
3297953	Casale SA	04/05/2016	3297953	16720825.5	
3298019	Dow Silicones Corporation	01/04/2016	3298019	16796876.7	
3298166	NIPD GENETICS PUBLIC COMPANY LIMITED	20/05/2016	3298166	16738215.9	
3298493	Qualcomm Incorporated	08/04/2016	3298493	16717073.7	
3298575	Magic Pony Technology Limited	14/03/2017	3298575	17713051.5	
3298648	Sonova AG	18/05/2015	3298648	15725896.3	
3298742	Huawei Technologies Co., Ltd.	06/06/2016	3298742	16806793.2	
3298798	Robert Bosch GmbH	22/04/2016	3298798	16720078.1	German
3299228	VOLKSWAGEN AKTIENGESELLSCHAFT	24/07/2017	3299228	17182838.7	German
3299556	ASSA ABLOY (Schweiz) AG	18/09/2017	3299556	17191549.9	German
3299589	Rolls-Royce plc	23/08/2017	3299589	17187450.6	

3299740	TROX GmbH	12/04/2017	3299740	17166224.0	German
3299747	Shanghai Ocean University	16/12/2015	3299747	15881416.0	
3300343	Google Technology Holdings LLC	30/09/2004	3300343	17200307.1	
3300763	FMD Co., Ltd.	01/08/2017	3300763	17001321.3	
3300991	JTEKT CORPORATION	26/09/2017	3300991	17193268.4	
3301661	GE Aviation Systems LLC	29/09/2017	3301661	17194022.4	
3301709	GE Energy Power Conversion Technology Ltd	11/09/2017	3301709	17190358.6	
3301732	LG Display Co., Ltd.	29/09/2017	3301732	17194157.8	
3302060	Kaohsiung Medical University	26/05/2016	3302060	16800725.0	
3302204	LG Electronics Inc.	25/05/2016	3302204	16800297.0	
3302822	Josef Schiele OHG	24/05/2016	3302822	16725498.6	German
3302846	Novelis, Inc.	26/05/2016	3302846	16728186.4	
3303306	Acetylon Pharmaceuticals, Inc.	08/06/2016	3303306	16731454.1	
3303576	ESTEVE PHARMACEUTICALS, S.A. Universitat Autònoma De Barcelona	03/06/2016	3303576	16730716.4	
3303713	Sarl Le Prieure	26/05/2016	3303713	16727655.9	French
3303824	Dynavec AS	25/05/2016	3303824	16800365.5	
3304238	Emerson Process Management Regulator Technologies, Inc.	03/06/2016	3304238	16732057.1	
3304312	New York University The Board of Trustees of the Leland Stanford Junior University	06/06/2016	3304312	16808080.2	
3304992	Telefonaktiebolaget LM Ericsson (publ)	13/05/2016	3304992	16725594.2	
3305139	Rückerl, Manuela	06/10/2017	3305139	17195339.1	German
3305152	Tok Bearing Co., Ltd.	12/05/2016	3305152	16799830.1	
3305493	Pascal Engineering Corporation	03/06/2016	3305493	16803510.3	
3305737	Corning Incorporated	25/10/2012	3305737	17198848.8	
3305847	Nippon Paint Surf Chemicals Co., Ltd.	03/06/2016	3305847	16803529.3	
3305920	Gen-Probe Incorporated	12/07/2011	3305920	17202512.4	
3305932	JFE Steel Corporation	26/05/2016	3305932	16802784.5	
3306217	Lindinvent AB	04/10/2016	3306217	16192177.0	
3306854	Quantaglion Co., Ltd.	02/06/2016	3306854	16802822.3	
3306875	Huawei Technologies Co., Ltd.	27/06/2016	3306875	16858712.9	
3307120	Alto-Shaam, Inc.	04/05/2016	3307120	16807975.4	
3307457	Fill Gesellschaft m.b.H.	15/06/2016	3307457	16741520.7	German
3307458	Fill Gesellschaft m.b.H.	15/06/2016	3307458	16741521.5	German

3308040	LISI Aerospace	10/06/2016	3308040	16732506.7	French
3308419	Imperial College Innovations Limited	09/06/2016	3308419	16729337.2	
3308601	Nokia Technologies Oy	11/06/2015	3308601	15894635.0	
3308816	W.L. Gore & Associates, Inc	29/10/2010	3308816	17195666.7	
3308924	Bridgestone Corporation	07/06/2016	3308924	16807477.1	
3309241	UBPM Umwelt-Beratung und Produkt- Management GmbH & Co. KG	16/10/2017	3309241	17196543.7	German
3309823	FUJIFILM SonoSite, Inc.	18/09/2009	3309823	17190476.6	
3310064	Hisense Electric Co., Ltd. Hisense International Co., Ltd.	11/12/2017	3310064	17206325.7	
3310141	Toray Industries, Inc.	06/06/2016	3310141	16807413.6	
3310418	Caire Inc.	22/06/2016	3310418	16815198.3	
3310508	Künkel Wagner Germany GmbH	15/06/2016	3310508	16731979.7	German
3310917	The Broad Institute, Inc. Massachusetts Institute of Technology President and Fellows of Harvard College	17/06/2016	3310917	16734803.6	
3311024	Maintech AS	17/06/2016	3311024	16812018.6	
3311062	Coolsome Oy	17/06/2016	3311062	16741973.8	
3311133	Commissariat à l'énergie atomique et aux énergies alternatives	16/06/2016	3311133	16729908.0	French
3311383	Mashtraxx Limited	22/06/2016	3311383	16744830.7	
3311454	Kla-Tencor Corporation	22/06/2016	3311454	16815239.5	
3311480	Danfoss Editron Oy	08/06/2016	3311480	16811081.5	
3312434	Eagle Industry Co., Ltd.	16/06/2016	3312434	16814249.5	
3312538	Hamilton Sundstrand Corporation	20/10/2017	3312538	17197482.7	
3312548	Rheinmetall Waffe Munition GmbH	11/10/2017	3312548	17196035.4	German
3312642	Samsung Electronics Co., Ltd.	01/09/2017	3312642	17189006.4	
3312756	Trustonic Limited	27/09/2017	3312756	17193379.9	
3312903	Samsung Electronics Co., Ltd.	18/10/2017	3312903	17197061.9	
3313033	Sony Corporation	15/03/2016	3313033	16811273.8	
3313342	Ruggli Projects AG	22/06/2016	3313342	16731594.4	German
3313958	Rohm And Haas Electronic Materials Korea Ltd.	13/05/2016	3313958	16814586.0	
3314133	A. RAYMOND et Cie	21/06/2016	3314133	16736906.5	French
3314401	Microsoft Technology Licensing, LLC	23/06/2016	3314401	16736333.2	
3315295	The Boeing Company	27/10/2017	3315295	17198841.3	

3315333	Toyota Material Handling Manufacturing Sweden AB	01/11/2016	3315333	16196729.4	
3315517	LG Chem, Ltd.	24/06/2016	3315517	16814755.1	
3315597	Tets, Viktor Veniaminovich Tets, Georgy Viktorovich	23/06/2016	3315597	16814798.1	
3315621	Meidensha Corporation	21/06/2016	3315621	16814321.2	
3315685	Ivan, Lucian	31/10/2017	3315685	17275177.8	
3315775	Lufkin Industries, LLC	19/11/2013	3315775	17202438.2	
3315885	BSH Hausgeräte GmbH	06/10/2017	3315885	17195278.1	
3316104	Wacom Co., Ltd.	16/06/2016	3316104	16814247.9	
3316746	Koninklijke Douwe Egberts B.V.	30/06/2016	3316746	16745526.0	
3317051	Festool GmbH	28/06/2016	3317051	16733490.3	German
3317511	Robert Bosch GmbH	09/05/2016	3317511	16722859.2	German
3317736	NEXTracker, Inc.	30/06/2016	3317736	16742356.5	French
3318045	Mist Systems, Inc.	22/06/2016	3318045	16818483.6	
3318155	Wonderland Nurserygoods Company Limited	07/11/2017	3318155	17200386.5	
3318204	Enraf Nonius B.V.	08/11/2016	3318204	16197716.0	
3318216	Lee, Jin Kyun	04/11/2016	3318216	16197274.0	
3318392	The Boeing Company	10/10/2017	3318392	17195735.0	
3318716	General Electric Company	04/11/2016	3318716	16461568.4	
3318922	Samsung Display Co., Ltd.	18/10/2017	3318922	17197170.8	
3319475	Mitchell Terrace Pty. Ltd.	06/07/2016	3319475	16820569.8	
3319585	Beiersdorf AG	21/06/2016	3319585	16731134.9	German
3319622	CureVac AG	22/12/2016	3319622	16826337.4	
3320042	ARKEMA FRANCE	08/07/2016	3320042	16740985.3	
3320667	ADUCID s.r.o.	06/07/2016	3320667	16754389.1	
3320842	Fujifilm Corporation	27/06/2016	3320842	16821013.6	
3321253	Siga Technologies, Inc.	14/08/2013	3321253	17203980.2	
3321279	BrightGene Bio-Medical Technology Co., Ltd.	13/09/2016	3321279	16848039.0	
3321415	LG Electronics Inc.	13/11/2017	3321415	17201241.1	
3321558	Daewoo Shipbuilding & Marine Engineering Co., Ltd.	29/06/2016	3321558	16821574.7	
3321970	3-5 Power Electronics GmbH	10/11/2017	3321970	17001843.6	German
3322391	Avintiv Specialty Materials Inc.	15/07/2016	3322391	16741814.4	
3322578	Stratasys Ltd.	13/07/2016	3322578	16744545.1	

3322693	Rohm And Haas Electronic Materials Korea Ltd.	25/04/2016	3322693	16811807.3	
3322947	Linde AG	14/07/2016	3322947	16738675.4	German
3323327	X.J. Electronics (Shenzhen) Co., Ltd	29/12/2016	3323327	16207381.1	
3323567	FINEWELL Co., Ltd.	14/07/2016	3323567	16824527.2	
3323657	TOYOTA JIDOSHA KABUSHIKI KAISHA	16/10/2017	3323657	17196696.3	
3323900	UACJ Corporation	29/06/2016	3323900	16824267.5	
3324000	United Technologies Corporation	17/11/2017	3324000	17202419.2	
3324004	United Technologies Corporation	17/11/2017	3324004	17202447.3	
3324116	Sec Elevator Co., Ltd.	21/07/2015	3324116	15898327.0	
3324390	Beijing Xiaomi Mobile Software Co., Ltd.	21/11/2017	3324390	17202868.0	
3324602	Accenture Global Solutions Limited	17/10/2017	3324602	17196771.4	
3324653	Sony Corporation	01/07/2016	3324653	16824293.1	
3324719	FUJI Corporation	13/07/2015	3324719	15898244.7	
3324768	Beyeler, Patrick G.	12/07/2016	3324768	16747746.2	German
3325078	Strataca Systems Limited	20/07/2016	3325078	16828458.6	
3325313	Gentex Corporation	28/09/2016	3325313	16852462.7	
3325865	Fisher Controls International LLC	18/07/2016	3325865	16751708.5	
3325870	AMTROL Licensing Inc.	21/07/2016	3325870	16828527.8	
3325925	Ginolis Oy	13/07/2016	3325925	16738432.0	
3326174	GE-Hitachi Nuclear Energy Americas LLC	20/06/2016	3326174	16739291.9	
3326226	Umicore Umicore Korea Ltd.	07/07/2016	3326226	16827327.4	
3326265	Siemens Aktiengesellschaft	16/08/2016	3326265	16757589.3	German
3326401	Legic Identsystems AG	23/06/2016	3326401	16751482.7	
3326475	Rossignol Apparel	08/11/2017	3326475	17200483.0	French
3326549	Ethicon LLC	26/03/2015	3326549	18150883.9	
3326603	Bosnak, Matevz Skrjanc, Igor Univerza v Ljubljani Fakulteta za elektrotehniko	24/11/2016	3326603	16002500.3	
3326742	Nanjing Chervon Industry Co., Ltd.	24/11/2017	3326742	17203433.2	
3327112	DSM IP Assets B.V.	19/07/2013	3327112	17203395.3	
3327426	Universität Siegen	24/11/2016	3327426	16200599.5	

3327925	MITSUBISHI HEAVY INDUSTRIES THERMAL SYSTEMS, LTD.	27/11/2017	3327925	17203904.2	
3328516	Commissariat à l'Énergie Atomique et aux Énergies Alternatives	28/07/2016	3328516	16745700.1	French
3328664	Pirelli Tyre S.p.A.	28/07/2016	3328664	16754328.9	
3329154	Poclain Hydraulics Industrie	27/07/2016	3329154	16744751.5	French
3329215	Volvo Truck Corporation	28/07/2015	3329215	15801930.7	
3329356	Apple Inc.	12/07/2017	3329356	17743156.6	
3329781	Food Processing Equipment S.r.l.	01/12/2017	3329781	17205006.4	
3330122	AGUTI PRODUKTENTWICKLUNG & DESIGN GMBH	27/11/2017	3330122	17203687.3	German
3330163	TOYOTA JIDOSHA KABUSHIKI KAISHA	14/11/2017	3330163	17201631.3	
3330252	Signum Biosciences, Inc.	11/11/2009	3330252	18150768.2	
3330383	Geron Corporation	13/10/2009	3330383	17194587.6	
3331077	Kyocera Corporation	27/07/2016	3331077	16830560.5	
3331671	Robertson, Ruairidh	04/08/2016	3331671	16833884.6	
3332585	Qualcomm Incorporated	06/07/2016	3332585	16745924.7	
3332740	Edwards Lifesciences PVT, Inc.	11/10/2002	3332740	17199786.9	
3333015	König, Marc	06/12/2017	3333015	17205612.9	German
3333398	AVL List GmbH	16/11/2017	3333398	17202118.0	German
3333435	Honeywell International Inc.	30/11/2017	3333435	17204765.6	
3333714	COMMISSARIAT À L'ÉNERGIE ATOMIQUE ET AUX ÉNERGIES ALTERNATIVES	07/12/2016	3333714	16306629.3	
3334510	3M Innovative Properties Company	10/08/2016	3334510	16753792.7	
3334540	Koninklijke Philips N.V.	02/08/2016	3334540	16757083.7	
3334980	Koninklijke Philips N.V.	26/05/2017	3334980	17727177.2	
3335066	Adamczyk, Hubert	08/08/2016	3335066	16756622.3	
3335107	Microsoft Technology Licensing, LLC	18/07/2016	3335107	16748396.5	
3335239	Commissariat à l'Énergie Atomique et aux Énergies Alternatives	08/08/2016	3335239	16750789.6	French
3335307	Koninklijke Philips N.V.	29/07/2016	3335307	16744784.6	
3335557	JVS Products Limited	29/08/2014	3335557	17200374.1	
3335687	Ivoclar Vivadent AG	15/12/2016	3335687	16204527.2	German
3335907	Continental Reifen Deutschland GmbH	12/10/2017	3335907	17196088.3	German
3335963	Wonderland Switzerland AG	28/11/2017	3335963	17204060.2	

3336110	LG Chem, Ltd.	07/06/2017	3336110	17815626.1	
3336316	Mitsubishi Hitachi Power Systems, Ltd.	01/08/2016	3336316	16835011.4	
3336343	MAN Energy Solutions, filial af MAN Energy Solutions SE, Tyskland	11/12/2017	3336343	17206427.1	
3336376	Robert Bosch GmbH	14/12/2017	3336376	17207201.9	German
3336377	Robert Bosch GmbH	14/12/2017	3336377	17207223.3	German
3336439	Texas De France	15/12/2017	3336439	17207743.0	French
3336505	INGU Solutions Inc.	15/12/2017	3336505	17020577.7	
3336703	Palantir Technologies Inc.	14/12/2017	3336703	17207447.8	
3336718	CompuGroup Medical SE	16/12/2016	3336718	16204660.1	
3336740	NXP B.V.	16/12/2016	3336740	16204846.6	
3336743	Datalogic USA, Inc.	12/12/2017	3336743	17206854.6	
3336799	Hitachi-LG Data Storage, Inc.	19/12/2017	3336799	17208596.1	
3336842	NXP B.V.	19/12/2016	3336842	16205014.0	
3337404	Prof. Dr. Claus Bachert BVBA	21/08/2015	3337404	15766061.4	
3337541	Philip Morris Products S.A.	18/08/2016	3337541	16759996.8	
3337753	RWE Power Aktiengesellschaft	16/08/2016	3337753	16751606.1	German
3337955	Halliburton Energy Services, Inc.	21/10/2015	3337955	15906835.2	
3338314	Novald GmbH	18/08/2016	3338314	16760402.4	
3338498	Telefonaktiebolaget LM Ericsson (publ)	19/08/2016	3338498	16763112.6	
3338610	Eurofilters Holding N.V.	23/12/2016	3338610	16206569.2	German
3338685	Ethicon LLC	21/12/2017	3338685	17209471.6	
3338817	Slaski Uniwersytet Medyczny w Katowicach Instytut Biopolimerów I Włókien Chemicznych	22/12/2017	3338817	17210150.3	
3338830	EPIC MEDICAL PTE LTD	22/12/2017	3338830	17209918.6	
3339215	ASP Automation GmbH	11/12/2017	3339215	17206383.6	German
3339255	Beteiligungen Sorg GmbH & Co. KG	21/12/2017	3339255	17209616.6	German
3339406	International Flavors & Fragrances Inc.	20/10/2017	3339406	17197533.7	
3339502	AGFA NV	20/12/2016	3339502	16205212.0	
3339525	F.J. Aschwanden AG	22/12/2016	3339525	16206446.3	German
3339531	Finnfoam Oy	19/12/2017	3339531	17208335.4	
3340023	Dassault Systèmes	22/12/2016	3340023	16306773.9	
3340255	LG Chem, Ltd.	26/08/2016	3340255	16848812.0	
3340579	VEEA Systems LTD	21/12/2017	3340579	17209308.0	
3340634	Huawei Technologies Co., Ltd.	26/04/2013	3340634	18151319.3	

3340797	Dow Global Technologies LLC	11/08/2015	3340797	15900715.2	
3341448	Merck Patent GmbH	29/07/2016	3341448	16745626.8	
3341853	Telefonaktiebolaget LM Ericsson (PUBL)	27/08/2015	3341853	15762946.0	
3342017	Technische Universiteit Delft	26/08/2016	3342017	16760826.4	
3342737	Ricoh Company, Ltd.	29/12/2017	3342737	17211173.4	
3342755	Sumitomo Osaka Cement Co., Ltd.	25/08/2016	3342755	16841667.5	
3343415	Limagrain Europe	27/12/2016	3343415	16306825.7	
3343838	Mellanox Technologies, Ltd.	21/12/2017	3343838	17209619.0	
3343840	Juniper Networks, Inc.	30/11/2017	3343840	17204769.8	
3343859	Samsung Electronics Co., Ltd.	02/11/2016	3343859	16862429.4	
3344002	Intel Corporation	29/12/2016	3344002	16207247.4	
3344399	Nordson Corporation	31/08/2016	3344399	16770595.3	
3344456	Pantex International S.p.A.	30/08/2016	3344456	16778452.9	
3344562	Autostore Technology AS	31/08/2016	3344562	16760047.7	
3344838	AGC Glass Europe	22/08/2016	3344838	16754288.5	French
3345440	Telefonaktiebolaget LM Ericsson (publ.)	04/09/2015	3345440	15767596.8	
3345588	Carefusion 303 Inc.	24/02/2014	3345588	18158827.8	
3345849	OCE Holding B.V.	21/12/2017	3345849	17209310.6	
3346473	Quanta Computer Inc.	29/06/2017	3346473	17178700.5	
3346805	Trilux GmbH & Co. KG	16/04/2012	3346805	18152507.2	German
3347156	Siemens Aktiengesellschaft Fraunhofer Gesellschaft zur Förderung der angewandten Forschung E.V.	12/10/2016	3347156	16784429.9	German
3347438	Shell Internationale Research Maatschappij B.V.	05/09/2016	3347438	16760105.3	
3347742	Uniwersytet Jagiellonski	07/09/2015	3347742	15781454.2	
3348577	Chengdu Huachuang Biotechnology Co., Ltd	22/10/2015	3348577	15906480.7	
3348644	CureVac AG	15/02/2013	3348644	17207479.1	
3349337	Robert Bosch GmbH	20/12/2017	3349337	17209171.2	German
3349958	JTEKT Europe	16/09/2016	3349958	16781499.5	French
3350017	Adient Luxembourg Holding S.à r.l.	15/09/2016	3350017	16766003.4	German
3350173	Boehringer Ingelheim International GmbH	16/09/2016	3350173	16766321.0	
3350359	Savroc Ltd	08/09/2016	3350359	16843730.9	

3350865	Umicore Umicore Korea Ltd.	15/09/2016	3350865	16845812.3	
3351635	Devgen NV	20/04/2012	3351635	17203802.8	
3352248	LG Chem, Ltd.	03/04/2017	3352248	17775948.7	
3353018	Federal-Mogul S.A.	24/09/2015	3353018	15767505.9	
3353098	Habasit AG	21/09/2016	3353098	16769998.2	
3353132	USG Interiors, LLC	13/09/2016	3353132	16775915.8	
3353382	Atlas Copco Airpower, Naamloze Vennootschap	19/09/2016	3353382	16787710.9	
3353390	Jacobs Vehicle Systems, Inc. BorgWarner Inc.	22/09/2016	3353390	16849586.9	
3353455	Bloechlinger Engineering AG	20/09/2016	3353455	16777934.7	German
3353984	Qualcomm Incorporated	16/09/2016	3353984	16775400.1	
3354154	Wu, Chen-Chuan	11/04/2017	3354154	17165956.8	
3354427	Comelz S.p.A.	18/01/2018	3354427	18152302.8	
3354508	VOLKSWAGEN AKTIENGESELLSCHAFT	19/12/2017	3354508	17208287.7	German
3354753	Vanda Pharmaceuticals Inc.	05/04/2010	3354753	18160989.2	
3354777	Unitika Trading Co., Ltd.	15/06/2017	3354777	17813379.9	
3355071	Samsung Electronics Co., Ltd.	16/11/2016	3355071	16873249.3	
3355296	BOE Technology Group Co., Ltd. Beijing BOE Display Technology Co., Ltd.	03/03/2016	3355296	16781656.0	
3355312	Mitsubishi Heavy Industries, Ltd.	07/03/2016	3355312	16848339.4	
3355390	Samsung Electronics Co., Ltd. Samsung SDI Co., Ltd.	05/12/2017	3355390	17205477.7	
3355517	Huawei Technologies Co., Ltd.	24/06/2016	3355517	16858709.5	
3355702	Bunge Loders Croklaan B.V.	15/09/2016	3355702	16769943.8	
3356249	Bernasconi, Brunello	28/09/2016	3356249	16794404.0	
3356428	Arkema France	30/09/2016	3356428	16788157.2	French
3356630	Düperthal Sicherheitstechnik GmbH & Co.KG	01/10/2015	3356630	15780803.1	German
3356828	Abbott Japan Co., Ltd. The University of Tokyo	28/09/2016	3356828	16788569.8	
3356879	Verily Life Sciences LLC	23/08/2016	3356879	16759928.1	
3357118	Intelligent Energy Limited	23/09/2016	3357118	16787916.2	
3357119	Intelligent Energy Limited	28/09/2016	3357119	16787921.2	

3357345	DSM IP Assets B.V.	22/12/2006	3357345	18155969.1	
3357417	Omron Corporation	23/08/2016	3357417	16850961.0	
3357884	Panasonic Intellectual Property Management Co., Ltd.	14/09/2016	3357884	16850600.4	
3357933	Cansino Biologics Inc.	09/09/2016	3357933	16850259.9	
3357980	Konica Minolta, Inc.	29/12/2017	3357980	17211024.9	
3358264	Samsung Electronics Co., Ltd.	28/09/2016	3358264	16852044.3	
3358300	Huawei Technologies Co., Ltd.	30/09/2015	3358300	15905117.6	
3358489	FUJITSU LIMITED	05/02/2018	3358489	18155072.4	
3358732	Mitsubishi Electric Corporation	01/10/2015	3358732	15905452.7	
3359073	St. Jude Medical, Cardiology Division, Inc.	18/11/2016	3359073	16805684.4	
3359378	BWG Bergwerk- Und Walzwerk- Maschinenbau GmbH	20/09/2016	3359378	16778237.4	German
3359550	Rohm and Haas Electronic Materials LLC DOW GLOBAL TECHNOLOGIES LLC	08/10/2015	3359550	15905661.3	
3359883	Morello Forni di Morello Marco&C. S.A.S.	29/09/2016	3359883	16795147.4	
3359922	BERKIN B.V.	10/10/2016	3359922	16790746.8	
3359950	Universiteit Gent	05/10/2016	3359950	16784412.5	
3360138	Das, Samarjit Sousa, Joao P. Robert Bosch GmbH	11/11/2015	3360138	15802261.6	
3360530	Mitsubishi Gas Chemical Company, Inc.	03/10/2016	3360530	16853510.2	
3360718	DENSO TEN Limited TOYOTA JIDOSHA KABUSHIKI KAISHA	12/12/2008	3360718	18162663.1	
3360934	FUJIFILM Corporation	05/10/2016	3360934	16853661.3	
3361044	Chevron U.S.A. Inc.	21/08/2015	3361044	18158876.5	
3361462	Panasonic Intellectual Property Management Co., Ltd.	08/12/2017	3361462	17206259.8	
3361522	Sony Corporation	04/04/2017	3361522	17164837.1	
3361599	O2Micro, Inc.	13/02/2018	3361599	18156409.7	
3362216	Iscar Ltd.	25/07/2016	3362216	16757085.2	

3362289	OCE-TECHNOLOGIES B.V.	07/10/2016	3362289	16778378.6	
3362432	DOW GLOBAL TECHNOLOGIES LLC	28/09/2016	3362432	16778623.5	
3362860	Honeywell International Inc.	12/10/2016	3362860	16785319.1	
3363121	Nokia Solutions and Networks Oy	12/10/2015	3363121	15778932.2	
3364081	Wuxi Fucare Industrial Co., Ltd	16/11/2015	3364081	15907052.3	
3364257	Siemens Aktiengesellschaft	21/02/2017	3364257	17157080.7	German
3365194	Catac Capital GmbH	16/09/2016	3365194	16766545.4	German
3365226	Danielson Aircraft Systems	21/10/2016	3365226	16806217.2	French
3365258	Stoneage, Inc.	06/10/2016	3365258	16857990.2	
3366551	Robert Bosch GmbH	22/12/2017	3366551	17210024.0	German
3366718	The University Of Tokyo Sumitomo Seika Chemicals Co., Ltd.	18/10/2016	3366718	16857439.0	
3366719	Bridgestone Corporation	17/10/2016	3366719	16857095.0	
3366900	Mitsubishi Heavy Industries Engine & Turbocharger, Ltd.	27/11/2015	3366900	15909294.9	
3367469	Envision AESC Japan Ltd.	22/10/2015	3367469	15906710.7	
3367967	Contego Medical, LLC	27/10/2016	3367967	16791781.4	
3368132	Becton, Dickinson and Company	06/10/2016	3368132	16790465.5	
3368156	St. Jude Medical, Cardiology Division, Inc.	15/11/2016	3368156	16809580.0	
3368720	Mærsk Drilling A/S Total S.A.	06/10/2016	3368720	16794509.6	
3368722	Mærsk Drilling A/S Total S.A.	31/10/2016	3368722	16815707.1	
3368745	The Robbins Company	27/10/2016	3368745	16860823.0	
3368749	Safran Aircraft Engines	27/10/2016	3368749	16809122.1	French
3368800	Tenneco Inc.	28/10/2016	3368800	16794845.4	
3368825	Outotec (Finland) Oy	28/10/2016	3368825	16795401.5	
3368876	Linde Aktiengesellschaft	20/10/2016	3368876	16790912.6	
3368970	Google LLC	22/12/2016	3368970	16828839.7	
3368988	Displaylink (UK) Limited	18/10/2016	3368988	16784274.9	
3369880	Mitsubishi Jidosha Kogyo Kabushiki Kaisha	02/03/2018	3369880	18159757.6	
3370213	Panasonic Intellectual Property Management Co., Ltd.	04/08/2016	3370213	16859229.3	

3371280	Shell Internationale Research Maatschappij B.V.	31/10/2016	3371280	16790958.9	
3371428	Plastic Omnium Advanced Innovation and Research	03/11/2016	3371428	16790389.7	
3371469	Innio Jenbacher GmbH & Co OG	07/11/2016	3371469	16794979.1	
3371703	Intel IP Corporation	18/05/2016	3371703	16736288.8	
3371803	Razer (Asia Pacific) Pte. Ltd.	03/11/2015	3371803	15907901.1	
3372053	Arçelik Anonim Sirketi	06/11/2015	3372053	15790588.6	
3372693	KAO CORPORATION	07/06/2017	3372693	17823926.5	
3373295	Dolby Laboratories Licensing Corporation	12/06/2014	3373295	18156452.7	
3373407	VARTA Microbattery GmbH	10/03/2017	3373407	17160379.8	German
3373565	Samsung Electronics Co., Ltd.	08/03/2018	3373565	18160684.9	
3373652	Sony Corporation	24/10/2016	3373652	16861445.1	
3373751	Philip Morris Products S.A.	07/11/2016	3373751	16793842.2	
3374329	CeramTec GmbH	10/11/2016	3374329	16795015.3	German
3374405	Dow Global Technologies LLC Dow Brasil Sudeste Industrial Ltda.	10/11/2016	3374405	16801916.4	
3374741	Oxeau Invest	08/11/2016	3374741	16806257.8	French
3375227	GreenPeak Technologies B.V.	12/11/2015	3375227	15828886.0	
3375238	Huawei Technologies Co., Ltd.	17/12/2016	3375238	16874933.1	
3375340	CONTA S.R.O	13/03/2018	3375340	18161491.8	
3376001	Isuzu Motors Limited	09/11/2016	3376001	16864246.0	
3376002	Isuzu Motors Limited	09/11/2016	3376002	16864253.6	
3376151	Steel Action GmbH	16/03/2017	3376151	17161425.8	German
3376228	Helmholtz-Institut Braunschweig Karlsruher Institut für Technologie	16/03/2018	3376228	18162230.9	German
3376382	SAP SE	02/05/2017	3376382	17000761.1	
3377007	Braincool AB	18/11/2016	3377007	16798712.2	
3377329	Goller IPR ApS	17/11/2016	3377329	16801956.0	
3377343	Bluebus	09/11/2016	3377343	16805302.3	French
3377691	Mermet	18/11/2016	3377691	16809997.6	French
3377699	Plasser & Theurer Export von Bahnbaumaschinen Gesellschaft m.b.H.	21/10/2016	3377699	16788021.0	German
3377723	FMC Technologies, Inc.	16/11/2015	3377723	15797817.2	
3378342	NIKE Innovate C.V.	26/06/2014	3378342	18172477.4	

3378774	FLARIS Spolka z ograniczona odpowiedzialnoscia	21/03/2017	3378774	17161974.5	
3379035	Stein Seal Company	24/08/2016	3379035	18151958.8	
3379099	HONDA MOTOR CO., LTD.	01/03/2018	3379099	18159450.8	
3379295	Honeywell International Inc.	16/03/2018	3379295	18162432.1	
3379339	CANON KABUSHIKI KAISHA	13/12/2013	3379339	18166572.0	
3379527	Casio Computer Co., Ltd.	08/03/2018	3379527	18160770.6	
3379552	dormakaba Deutschland GmbH	22/03/2017	3379552	17162441.4	German
3379598	Contemporary Amperex Technology Co., Limited	14/03/2018	3379598	18161657.4	
3379698	Jinlong Machinery & Electronics (Dongguan) Co., Ltd.	11/10/2017	3379698	17275162.0	
3379741	ViaSat Inc.	18/07/2013	3379741	18164440.2	
3379985	Kenwood Limited	25/11/2016	3379985	16804888.2	
3380263	Cucchi Giovanni & C. S.r.l.	23/11/2016	3380263	16800967.8	
3380843	Zelda Therapeutics Operations Pty Ltd	20/10/2017	3380843	17862681.8	
3381003	Mobeewave Inc.	01/12/2016	3381003	16881348.3	
3381040	NKT HV Cables AB	23/11/2015	3381040	15798109.3	
3381926	Samsung Electronics Co., Ltd.	27/03/2018	3381926	18164177.0	
3382209	Mitsubishi Heavy Industries Engine & Turbocharger, Ltd.	15/02/2016	3382209	16890455.5	
3382353	Zollern GmbH & Co. KG	06/03/2018	3382353	18160257.4	German
3382958	Nokia Solutions and Networks Oy	31/03/2017	3382958	17164143.4	
3383068	Starkey Laboratories, Inc.	29/03/2018	3383068	18165145.6	
3383312	Kulzer GmbH	01/12/2016	3383312	16805410.4	German
3383322	Tendyne Holdings, Inc.	02/12/2016	3383322	16813201.7	
3383454	Sanofi-Aventis Deutschland GmbH	28/11/2016	3383454	16802060.0	
3383466	Drägerwerk AG & Co. KGaA	21/11/2016	3383466	16798412.9	German
3383511	Rottfella AS	30/11/2016	3383511	16826196.4	
3383558	Universität Hohenheim	20/12/2016	3383558	16816684.1	German
3383739	de Havilland Aircraft of Canada Limited	25/11/2016	3383739	16805527.5	
3383759	MJN U.S. Holdings LLC	14/11/2016	3383759	16798374.1	
3383762	Constantia Teich GmbH	19/10/2016	3383762	16800871.2	German
3383827	Refractory Intellectual Property GmbH & Co. KG	01/12/2015	3383827	15805137.5	German
3384355	ABB Schweiz AG	03/12/2015	3384355	15804505.4	

3384391	Microsoft Technology Licensing, LLC	24/11/2016	3384391	16816056.2	
3384757	Kverneland Group Kerteminde AS	04/04/2017	3384757	17164804.1	German
3384816	Henny Penny Corporation	06/04/2018	3384816	18166077.0	
3385316	The Goodyear Tire & Rubber Company	30/03/2018	3385316	18165332.0	
3385401	POSCO	02/12/2016	3385401	16871071.3	
3385585	ArianeGroup GmbH	11/09/2017	3385585	17190457.6	
3385744	Alps Alpine Co., Ltd.	06/10/2016	3385744	16870290.0	
3385846	Huawei Technologies Co., Ltd.	30/12/2015	3385846	15911840.5	
3385877	Samsung Electronics Co., Ltd.	28/03/2018	3385877	18164698.5	
3385990	Acer Incorporated	10/11/2017	3385990	17201109.0	
3386137	Huawei Technologies Co., Ltd.	27/06/2012	3386137	17205613.7	
3386158	Mitsubishi Electric Corporation	07/04/2017	3386158	17305422.2	
3386252	Huawei Technologies Co., Ltd.	29/12/2015	3386252	15911759.7	
3386672	Marini S.p.A.	06/12/2016	3386672	16815556.2	
3386861	Cloth, Helmut	12/12/2016	3386861	16829230.8	German
3387051	Rohm and Haas Company	06/12/2016	3387051	16819769.7	
3387103	BASF SE	01/12/2016	3387103	16806033.3	
3387245	Pierburg GmbH	14/11/2016	3387245	16795065.8	German
	Ford-Werke GmbH				
3387258	Atlas Copco Airpower, Naamloze Vennootschap	23/08/2016	3387258	16815696.6	
3387356	Lochinvar, LLC	18/10/2016	3387356	16873522.3	
3387457	Koninklijke Philips N.V.	01/12/2016	3387457	16804800.7	
3387533	Microsoft Technology Licensing, LLC	06/12/2016	3387533	16819238.3	
3387635	Fundació Institut de Recerca de l'Hospital de la Santa Creu I Sant Pau Universitat Politècnica De Catalunya Fundació Institut de Bioenginyeria de Catalunya (IBEC)	12/12/2016	3387635	16810340.6	
3387636	Giesecke+Devrient Mobile Security GmbH	07/12/2016	3387636	16809288.0	German
3387648	Huawei Technologies Duesseldorf GmbH	22/12/2015	3387648	15817848.3	
3388268	Valmet Automotive Oy	06/04/2018	3388268	18166119.0	German
3388555	Commissariat à l'énergie atomique et aux énergies alternatives	11/04/2018	3388555	18166892.2	French
3388706	Nippon Steel Corporation	06/12/2016	3388706	16872971.3	

3388728	Mahle International GmbH	12/04/2017	3388728	17166373.5	
3388743	Delta Light NV	19/03/2018	3388743	18162448.7	
3388840	F. Hoffmann-La Roche AG	10/04/2017	3388840	17165689.5	
3388856	SZ DJI Technology Co., Ltd.	10/12/2015	3388856	15910076.7	
3388936	Vestel Elektronik Sanayi ve Ticaret A.S.	12/04/2017	3388936	17166189.5	
3389097	Commissariat à l'Énergie Atomique et aux Énergies Alternatives	11/04/2018	3389097	18166723.9	French
3389564	Innovheart S.r.l.	15/12/2016	3389564	16831523.2	
3389679	Maat Pharma Institut National De La Recherche Agronomique	19/12/2016	3389679	16826115.4	French
3390149	Konecranes Global Corporation	14/12/2016	3390149	16812935.1	German
3390179	Continental Teves AG & Co. OHG	06/12/2016	3390179	16812697.7	German
3390197	Siemens Mobility Austria GmbH	22/03/2017	3390197	17714664.4	German
3390256	Inventio AG	15/12/2016	3390256	16809841.6	German
3390264	Inventio AG	06/12/2016	3390264	16806119.0	German
3390270	Wasmunt B.V.	16/12/2016	3390270	16834205.3	
3390375	BASF SE Dow Global Technologies, LLC	16/12/2016	3390375	16813061.5	
3390380	BASF SE Kolon Plastics, Inc.	07/12/2016	3390380	16825330.0	
3390487	BASF Coatings GmbH	07/12/2016	3390487	16809350.8	German
3390488	BASF SE	08/12/2016	3390488	16806179.4	
3390533	Solvay Specialty Polymers Italy S.p.A.	14/12/2016	3390533	16819038.7	
3390815	Rijksuniversiteit Groningen	19/12/2016	3390815	16825914.1	
3390952	Christandl, Dieter	17/12/2015	3390952	15813064.1	German
3390958	RUAG Ammotec AG	08/12/2016	3390958	16815946.5	
3391014	Pirelli Tyre S.p.A.	16/12/2016	3391014	16834107.1	
3391045	Technische Universität Wien	14/12/2016	3391045	16820151.5	German
3391152	EULITHA A.G.	14/12/2016	3391152	16825567.7	
3391264	Koninklijke Philips N.V.	05/12/2016	3391264	16809691.5	
3391541	Cirrus Logic International Semiconductor Ltd.	19/06/2016	3391541	16741724.5	
3391694	Orange	24/11/2016	3391694	16815883.0	French
3391773	Cosmecca Korea Co., Ltd.	12/12/2016	3391773	16875987.6	
3391845	Boston Scientific Scimed, Inc.	23/06/2010	3391845	18177491.0	

3392060	Bridgestone Corporation	05/12/2016	3392060	16875455.4	
3392067	LR Intralogistik GmbH	02/03/2018	3392067	18159626.3	German
3392124	Zhejiang University	19/04/2018	3392124	18168167.7	
3392416	Hitachi Construction Machinery Co., Ltd	02/03/2018	3392416	18159683.4	
3392599	Trijicon, Inc.	29/06/2011	3392599	18177296.3	
3392619	Harman International Industries, Incorporated	16/04/2018	3392619	18167513.3	
3392624	VEGA Grieshaber KG	18/04/2017	3392624	17166957.5	German
3392664	D.E.M. S.p.A.	06/04/2018	3392664	18166065.5	
3393312	Koninklijke Philips N.V.	20/12/2016	3393312	16822975.5	
3393729	Safran Electronics & Defense B-Temia Inc.	23/12/2016	3393729	16825778.0	French
3393730	Safran Electronics & Defense B-Temia Inc.	23/12/2016	3393730	16825779.8	French
3393925	Bormioli Pharma S.p.A.	27/10/2016	3393925	16797996.2	
3394119	Compagnie Générale des Etablissements Michelin	22/12/2016	3394119	16829279.5	French
3394166	Compagnie Générale des Etablissements Michelin	22/12/2016	3394166	16829277.9	French
3394284	Venter Pharma, S.L	22/12/2016	3394284	16825747.5	
3394296	Arcelormittal	21/12/2016	3394296	16825409.2	
3394297	Arcelormittal	21/12/2016	3394297	16825741.8	
3394432	Vestas Wind Systems A/S	20/12/2016	3394432	16822892.2	
3394462	Volkswagen Aktiengesellschaft	12/12/2016	3394462	16810349.7	German
3394501	Signify Holding B.V.	09/12/2016	3394501	16816616.3	
3394512	SATENGINEERING S.A.S. DI FRANCESCO D'URSI & C.	21/12/2016	3394512	16826462.0	
3394516	Turbochef Technologies, Inc.	21/12/2016	3394516	16825658.4	
3394519	Koninklijke Philips N.V.	23/12/2016	3394519	16822687.6	
3394687	Sew-Eurodrive GmbH & Co. KG	06/12/2016	3394687	16818989.2	German
3394981	Newtec cy.	20/12/2016	3394981	16828938.7	
3395314	TRUMPF Medizin Systeme GmbH + Co. KG	25/04/2018	3395314	18169373.0	
3395401	MTG Co., Ltd.	26/09/2017	3395401	17193056.3	
3395547	Leister Technologies AG	28/04/2017	3395547	17168659.5	German
3395627	Valeo Autosystemy SP. Z.O.O.	26/04/2017	3395627	17461526.0	

3395810	Xuanzhu Pharma Co., Ltd.	23/12/2016	3395810	16877795.1	
3396029	Toyota Jidosha Kabushiki Kaisha	11/04/2018	3396029	18166859.1	
3396045	ELECTROLUX APPLIANCES AKTIEBOLAG	28/04/2017	3396045	17168682.7	
3396095	K+G Pneumatik GmbH	13/03/2018	3396095	18161616.0	German
3396813	PSA Automobiles SA	23/03/2018	3396813	18163635.8	French
3396975	Onkyo Corporation	24/04/2018	3396975	18168921.7	
3396979	Sivantos Pte. Ltd.	26/03/2018	3396979	18163937.8	German
3396990	Huawei Technologies Co., Ltd.	30/06/2016	3396990	16885960.1	
3397083	Philip Morris Products S.A.	19/12/2016	3397083	16822153.9	
3397312	Baxter Corporation Englewood	22/12/2016	3397312	16826566.8	
3397361	Geremia, Gianluca	30/12/2016	3397361	16838034.3	
3397505	Compagnie Générale des Etablissements Michelin	29/12/2016	3397505	16828881.9	
3397519	Vestas Wind Systems A/S	23/12/2016	3397519	16826288.9	
3397570	Giesecke+Devrient Currency Technology GmbH	22/12/2016	3397570	16822611.6	German
3397656	Superdielectrics Ltd	30/11/2016	3397656	16819354.8	
3397671	IFP Energies nouvelles	05/12/2016	3397671	16809695.6	French
3397770	Fondazione Istituto Italiano di Tecnologia	20/12/2016	3397770	16834285.5	
3397865	MELECS EWS GmbH	23/03/2017	3397865	17714669.3	German
3397934	Pirelli Tyre S.p.A.	22/12/2016	3397934	16836058.4	
3397975	ART-Fi	28/12/2016	3397975	16829248.0	
3398225	Airbus Defence and Space Limited	16/03/2017	3398225	17713386.5	
3398870	Cabka Group GmbH GreenCycle Umweltmanagement GmbH	02/05/2017	3398870	17169002.7	German
3398970	Agency for Science, Technology and Research	04/05/2018	3398970	18170831.4	
3399092	Dimore di Lucia Valzelli	04/05/2017	3399092	17425046.4	
3399106	Martin GmbH	04/05/2018	3399106	18170837.1	German
3399329	Intermec Inc.	02/05/2018	3399329	18170469.3	
3399519	Valeo Vision	24/04/2018	3399519	18169070.2	French
3399636	OSRAM GmbH	04/05/2018	3399636	18170751.4	
3400162	Valeo Schalter und Sensoren GmbH	14/12/2016	3400162	16822928.4	German

3400690	Panasonic Intellectual Property Management Co., Ltd.	21/12/2016	3400690	16883790.4	
3400835	Hettich Franke GmbH & Co. KG	07/05/2018	3400835	18171012.0	German
3400863	Winterhalter Gastronom GmbH	09/05/2018	3400863	18171508.7	German
3400973	Covidien LP	18/11/2014	3400973	18179020.5	
3401172	Valeo Interior Controls (Shenzhen) Co., Ltd	14/05/2018	3401172	18172070.7	
3401225	Eaton Intelligent Power Limited	09/05/2018	3401225	18171666.3	
3401303	Daicel Corporation	25/05/2017	3401303	17737197.8	
3401535	Mazda Motor Corporation	09/09/2016	3401535	16915721.1	
3401623	Qingdao Haier Joint Stock Co., Ltd	12/06/2016	3401623	16893177.2	
3401753	GUANGDONG OPPO MOBILE TELECOMMUNICATIONS CORP., LTD.	01/03/2018	3401753	18159466.4	
3402070	Infineon Technologies Austria AG	11/05/2017	3402070	17170697.1	
3402773	Johnson Matthey Davy Technologies Limited	16/12/2016	3402773	16816360.8	
3402774	Siemens Aktiengesellschaft	16/03/2017	3402774	17712440.1	German
3402995	DeArt Limited	13/01/2017	3402995	17705450.9	
3403420	Telefonaktiebolaget LM Ericsson (PUBL)	23/12/2016	3403420	16826061.0	
3403832	Ricoh Company, Ltd.	30/04/2018	3403832	18170209.3	
3403890	Illinois Tool Works Inc.	27/04/2018	3403890	18169703.8	
3403938	General Electric Company	26/04/2018	3403938	18169459.7	
3404137	LINEA 3 S.r.l.	14/05/2018	3404137	18171985.7	
3404371	Panasonic Intellectual Property Management Co., Ltd.	16/11/2016	3404371	16884843.0	
3404742	LG Chem, Ltd.	18/09/2017	3404742	17878937.6	
3404832	IMEC vzw	18/05/2017	3404832	17171725.9	
3404892	InterDigital CE Patent Holdings	03/05/2018	3404892	18170502.1	
3404894	Magic Leap, Inc.	29/10/2012	3404894	18182118.2	
3405627	Peri GmbH	22/12/2016	3405627	16822458.2	German
3406052	Chicago Mercantile Exchange Inc.	21/12/2017	3406052	17829869.1	
3406499	Komatsu Ltd.	24/03/2017	3406499	17774823.3	
3406563	Cargotec Patenter AB	22/05/2017	3406563	17172219.2	
3406800	TTI (Macao Commercial Offshore) Limited	22/05/2018	3406800	18173537.4	

3406871	Garrett Transportation I Inc.	14/05/2018	3406871	18172213.3	
3407429	Switchlab Inc. Switchlab (Shanghai) Co., Ltd.	25/05/2018	3407429	18174222.2	
3407454	COMMISSARIAT À L'ÉNERGIE ATOMIQUE ET AUX ÉNERGIES ALTERNATIVES	24/05/2018	3407454	18174000.2	French
3407640	Huawei Technologies Co., Ltd.	13/06/2010	3407640	18183083.7	
3408214	Newtechnik S.r.l.	23/01/2017	3408214	17709475.2	
3408458	Neoperl GmbH	26/01/2017	3408458	17704162.1	German
3408900	PHOENIX CONTACT Connector Technology GmbH	28/12/2016	3408900	16828927.0	German
3409212	Polo, Oscar	26/02/2018	3409212	18158667.8	
3409413	DANIELS MANUFACTURING CORPORATION	13/06/2017	3409413	17175859.2	
3409477	Seiko Epson Corporation	24/05/2018	3409477	18174157.0	
3409543	TOYOTA JIDOSHA KABUSHIKI KAISHA	22/05/2018	3409543	18173601.8	
3409617	Mann+Hummel GmbH	28/05/2018	3409617	18174539.9	
3409730	Kaneka Corporation	03/02/2017	3409730	17750186.3	
3409984	Rausch & Pausch GmbH	29/05/2018	3409984	18174671.0	German
3410088	AISIN SEIKI KABUSHIKI KAISHA	18/05/2018	3410088	18173117.5	
3410553	Schneider Electric IT Corporation	30/05/2018	3410553	18175240.3	
3411680	Robert Bosch GmbH	05/12/2016	3411680	16805831.1	German
3412130	Andreas Stihl AG & Co. KG	09/06/2017	3412130	17175381.7	German
3412252	Howmedica Osteonics Corp.	07/06/2018	3412252	18176659.3	
3412560	AeroMobil R&D, s. r. o.	05/06/2017	3412560	17174444.4	
3412585	Kabatec GmbH & Co. KG	29/05/2018	3412585	18020240.0	German
3412676	Rempex Pharmaceuticals, Inc.	08/08/2011	3412676	18183968.9	
3412829	ERMONT	07/06/2018	3412829	18176605.6	French
3413200	Honeywell International Inc.	23/05/2018	3413200	18173933.5	
3413499	Huawei Technologies Co., Ltd.	28/09/2010	3413499	18164191.1	
3413595	Huawei Technologies Co., Ltd.	01/03/2016	3413595	16891964.5	
3413773	Brainlab AG	19/04/2017	3413773	17719226.7	
3413863	EVALIA	08/02/2017	3413863	17707388.9	French
3413983	Flying Squirrel Sports, LLC	15/03/2016	3413983	16893776.1	
3414046	Quality Vision International, Inc.	22/12/2016	3414046	16826270.7	

3414546	Hewlett-Packard Development Company, L.P.	31/03/2016	3414546	16897342.8	
3414617	CSEM Centre Suisse d'Electronique et de Microtechnique SA - Recherche et Développement	20/12/2016	3414617	16819905.7	
3415032	MIUMA JEWELRY CO., LTD.	14/07/2017	3415032	17811174.6	
3415343	Continental Reifen Deutschland GmbH	19/03/2018	3415343	18162457.8	German
3415375	Witte Automotive GmbH	13/06/2018	3415375	18177571.9	German
3415406	Rocketail, LLC	15/06/2017	3415406	17176274.3	
3415416	Aurora Flight Sciences Corporation	08/06/2018	3415416	18176879.7	
3415463	AGRO Holding GmbH	15/06/2017	3415463	17176194.3	German
3415696	GROHEDAL Sanitärsysteme GmbH	25/05/2018	3415696	18174329.5	German
3415859	Sako OY	08/06/2018	3415859	18176730.2	
3416783	Viega Technology GmbH & Co. KG	16/02/2017	3416783	17705865.8	German
3416942	Evonik Operations GmbH	14/02/2017	3416942	17707484.6	
3417288	Colgate-Palmolive Company	21/03/2017	3417288	17718168.2	
3417343	Intercomet S.L.	17/02/2017	3417343	17704788.3	
3417636	Wirepas Oy	15/02/2017	3417636	17708847.3	
3417943	Eppendorf AG	21/06/2017	3417943	17177239.5	German
3418089	Bergstrom, Inc.	13/03/2014	3418089	18177850.7	
3418179	Marine Safety Products, LLC Beach-Drummond, James	22/08/2013	3418179	18187575.8	
3418515	FCA Italy S.p.A.	21/06/2017	3418515	17177057.1	
3418648	Thermor	20/06/2018	3418648	18178682.3	French
3418658	Samsung Electronics Co., Ltd.	28/07/2017	3418658	17834804.1	
3419015	Taylor-Listug, Inc.	12/06/2018	3419015	18177268.2	
3419205	GUANGDONG OPPO MOBILE TELECOMMUNICATIONS CORP., LTD.	14/02/2007	3419205	18189244.9	
3419705	Nerudia Ltd.	15/02/2017	3419705	17706860.8	
3419827	Saint-Gobain Glass France	23/02/2017	3419827	17710351.2	French
3419835	De La Rue International Limited	24/02/2017	3419835	17709741.7	
3419839	Continental Reifen Deutschland GmbH	20/12/2016	3419839	16828719.1	German
3420258	Neoperl GmbH	21/02/2017	3420258	17707168.5	German
3420429	Ecolab USA Inc.	23/02/2016	3420429	16706344.5	
3420871	CriNiGa Hinge d.o.o.	21/06/2018	3420871	18179153.4	
3421127	Cataler Corporation	23/02/2017	3421127	17756613.0	

3421419	SUEZ Groupe	30/06/2017	3421419	17305839.7	
3421620	JFE Steel Corporation	15/02/2017	3421620	17756317.8	
3421658	SEB S.A.	25/06/2018	3421658	18179682.2	French
3421695	Locinox	07/06/2018	3421695	18176445.7	
3421749	Pratt & Whitney Canada Corp.	29/06/2018	3421749	18181024.3	
3421839	Honda Motor Co., Ltd.	22/02/2017	3421839	17756550.4	
	Musashi Seimitsu Industry Co., Ltd.				
3421898	Daikin Industries, Ltd.	23/02/2017	3421898	17756614.8	
3422504	Mitsubishi Electric Corporation	24/02/2016	3422504	16891439.8	
3422631	Bedrock Automation Platforms Inc.	04/12/2014	3422631	18176358.2	
3422642	Cisco Technology, Inc.	18/12/2015	3422642	18188771.2	
3422704	Rovi Guides, Inc.	05/12/2007	3422704	18185917.4	
3422727	Vestel Elektronik Sanayi ve Ticaret A.S.	29/06/2017	3422727	17178744.3	
3422766	Huawei Technologies Co., Ltd.	31/03/2016	3422766	16895993.0	
3422878	JT International SA	24/02/2017	3422878	17707534.8	
3423259	Raytheon Company	11/10/2016	3423259	16788608.4	
3423380	Bisio Progetti S.p.a.	28/09/2016	3423380	16791685.7	
3423756	Carrier Corporation	04/03/2016	3423756	16713059.0	
3424202	Cisco Technology, Inc.	27/02/2017	3424202	17710649.9	
3424651	Board of Regents of the University of Nebraska	15/03/2013	3424651	18189171.4	
3424673	CEMA Technologies	30/04/2018	3424673	18170020.4	French
3424825	Ishida Co., Ltd.	01/12/2016	3424825	16892707.7	
3424853	Unicharm Corporation	29/02/2016	3424853	16892456.1	
3424931	Amgen Inc.	28/08/2015	3424931	18187957.8	
3425306	Daikin Industries, Ltd.	23/02/2017	3425306	17759815.8	
3425512	Juniper Networks, Inc.	31/05/2018	3425512	18175294.0	
3425793	N.V. Nuon Sales Nederland	04/05/2018	3425793	18170737.3	
3426080	CrossGuard IP B.V.	10/03/2017	3426080	17716070.2	
3426449	BOBST MEX SA	09/03/2017	3426449	17708975.2	French
3426452	Coriolis Group	07/03/2017	3426452	17713709.8	French
3426692	Dow Global Technologies LLC Rohm and Haas Company	06/03/2017	3426692	17713516.7	
3427014	Apator Miitors ApS	07/03/2016	3427014	16711769.6	
3427016	Chemspeed Technologies AG	02/03/2017	3427016	17712406.2	German
3427277	Corrada S.p.A	24/02/2017	3427277	17714285.8	

3427374	Huawei Technologies Co., Ltd.	07/04/2016	3427374	16714917.8	
3427505	GEMALTO M2M GmbH Thales Dis France SA	24/04/2017	3427505	17720424.5	
3427598	Wild Flavors, Inc.	07/11/2012	3427598	18170388.5	
3427853	TRUMPF Maschinen Austria GmbH & Co. KG.	04/07/2018	3427853	18181653.9	German
3428048	Huang, Kuan-Lung Chang, Chia-Jung	12/07/2018	3428048	18183228.8	
3428053	Naturgy Energy Group S.A.	06/07/2018	3428053	18382502.5	
3428080	Hecht Technologie GmbH	06/07/2018	3428080	18182206.5	German
3428156	3V SIGMA S.p.A	05/07/2018	3428156	18181956.6	
3428558	PHC Holdings Corporation	02/03/2017	3428558	17763073.8	
3428918	Harman Becker Automotive Systems GmbH	11/07/2017	3428918	17180703.5	
3429130	Cisco Technology, Inc.	05/07/2018	3429130	18182036.6	
3429734	ARCOLOR AG	14/03/2017	3429734	17712413.8	German
3429812	Ecolab USA Inc.	13/03/2017	3429812	17713548.0	
3429964	Durham University Saudi Arabian Oil Company	15/03/2017	3429964	17717920.7	
3430337	CEFLA Società Cooperativa	16/03/2017	3430337	17714296.5	
3430710	Ho, Kuokwa	22/02/2017	3430710	17765685.7	
3430784	Sprint Communications Company L.P.	10/03/2017	3430784	17714941.6	
3431134	Cardiac Pacemakers, Inc.	04/07/2018	3431134	18181790.9	
3431156	Spin Master Ltd.	10/10/2016	3431156	18162649.0	
3431247	GUANGDONG OPPO MOBILE TELECOMMUNICATIONS CORP., LTD.	11/07/2018	3431247	18182913.6	
3431250	Cooper Standard GmbH	17/07/2017	3431250	17181669.7	
3431274	Mitsubishi Heavy Industries, Ltd.	06/04/2017	3431274	17785809.9	
3431340	Zadi S.p.A.	17/07/2018	3431340	18183856.6	
3431342	Magneti Marelli S.p.A.	09/07/2018	3431342	18182362.6	
3431348	Volvo Car Corporation	18/07/2017	3431348	17181878.4	
3431400	Focke & Co. (GmbH & Co. KG)	09/07/2018	3431400	18000583.7	German
3431418	Voloskov, Mikhail	20/07/2017	3431418	17182351.1	
3431609	Masarykova Univerzita Masarykuv Onkologicky Ustav	17/07/2017	3431609	17181646.5	
3431748	Kuma Energy S.R.L.	19/07/2018	3431748	18184349.1	

3431761	Daikin Industries, Ltd.	21/03/2008	3431761	18192382.2	
3431788	Wieland-Werke AG	13/06/2018	3431788	18000516.7	German
3432629	Nokia Solutions and Networks Oy	20/07/2017	3432629	17182312.3	
3433106	K.G.S. S.R.L. UNIPERSONALE	23/03/2017	3433106	17724278.1	
3433130	Tofas Turk Otomobil Fabrikasi Anonim Sirketi	06/03/2017	3433130	17718161.7	
3433159	JTEKT Europe	23/03/2017	3433159	17716968.7	French
3433177	I.G.B. S.r.l.	26/05/2017	3433177	17732575.0	
3433215	Saint-Gobain Isover	14/03/2017	3433215	17714858.2	French
3433253	Theravance Biopharma R&D IP, LLC	27/04/2017	3433253	17722324.5	
3433531	Vivevit S.r.l. semplificata a socio unico	25/03/2016	3433531	16730015.1	
3433874	Shimadzu Corporation	22/03/2017	3433874	17712987.1	
3433984	Telefonaktiebolaget LM Ericsson (PUBL)	24/03/2016	3433984	16712039.3	
3434091	Baumer Electric AG	27/07/2017	3434091	17183613.3	
3434103	Certis Europe B.V.	25/07/2017	3434103	17183050.8	
3434106	Meyn Food Processing Technology B.V.	24/07/2018	3434106	18185157.7	
3434218	St. Jude Medical, Cardiology Division, Inc.	03/06/2015	3434218	18195074.2	
3434566	Nissan Motor Co., Ltd.	22/03/2016	3434566	16895343.8	
3434804	Nissan Motor Co., Ltd.	23/03/2016	3434804	16895361.0	
3434857	Coulisse B.V.	19/07/2018	3434857	18184526.4	
3434956	Staubli Faverges	24/07/2018	3434956	18185126.2	French
3434964	Bechter, Georg	27/07/2017	3434964	17183558.0	German
3434984	Hans Sasserath GmbH & Co. KG.	30/05/2018	3434984	18175082.9	German
3435076	Japan Aviation Electronics Industry, Limited Tohoku University	13/12/2016	3435076	16900531.1	
3435205	Dr. Schneider Kunststoffwerke GmbH	11/07/2018	3435205	18182820.3	German
3435394	Schneider Electric Industries SAS	25/07/2018	3435394	18185505.7	French
3435399	Schneider Electric Industries SAS	24/07/2018	3435399	18185134.6	French
3435738	Panasonic Intellectual Property Management Co., Ltd.	13/03/2017	3435738	17770007.7	
3436033	Baylor University	29/03/2017	3436033	17717972.8	
3436216	Ancora S.p.A.	30/03/2017	3436216	17726677.2	

3436299	Dana Heavy Vehicle Systems Group, LLC	28/03/2017	3436299	17716374.8	
3436379	Plockmatic International AB	31/03/2017	3436379	17717523.9	
3436412	Vesuvius France S.A.	30/03/2017	3436412	17713328.7	
3436621	Technic France	29/03/2017	3436621	17713038.2	
3436642	Ozkan, Aydin	03/03/2017	3436642	17717526.2	
3436664	NK Trading and Engineering GmbH	30/03/2017	3436664	17718486.8	German
3436666	Exergy S.p.A.	29/03/2017	3436666	17722154.6	
3436731	Verplas Limited	22/03/2017	3436731	17714529.9	
3436754	Carrier Corporation	31/03/2016	3436754	16714367.6	
3437588	Edwards Lifesciences Corporation	03/06/2013	3437588	18189665.5	
3437673	Schwingel, Jörg Hartmut	01/08/2018	3437673	18186864.7	German
3437748	SMS Group GmbH	02/07/2018	3437748	18181081.3	German
3437751	Nippon Steel Corporation	28/03/2017	3437751	17775070.0	
3437879	Brother Kogyo Kabushiki Kaisha	31/07/2017	3437879	17184060.6	
3437882	Artech GmbH design + production in plastic	01/08/2017	3437882	17184326.1	German
3437883	Artech GmbH design + production in plastic	01/08/2017	3437883	17184328.7	German
3437991	Bell Helicopter Textron Inc.	15/09/2017	3437991	17191478.1	
3438434	Yanmar Co., Ltd.	13/03/2017	3438434	17774245.9	
3438511	Carl Freudenberg KG EagleBurgmann Germany GmbH & Co. KG	12/07/2018	3438511	18183099.3	German
3438592	Fluke Corporation	03/08/2018	3438592	18187207.8	
3438870	Tata Consultancy Services Limited	02/08/2018	3438870	18186940.5	
3439125	Eldon Holding Aktiebolag	25/06/2018	3439125	18179435.5	German
3439373	VOLKSWAGEN AKTIENGESELLSCHAFT	12/07/2018	3439373	18183203.1	German
3440144	Dow Global Technologies, LLC	03/04/2017	3440144	17719758.9	
3440181	Henkel AG & Co. KGaA	27/03/2017	3440181	17713923.5	German
3440271	Junttan OY	07/04/2017	3440271	17726663.2	
3440295	Siegenia-Aubi KG	22/03/2017	3440295	17712764.4	German
3440343	Dragic, Mile	05/04/2017	3440343	17745527.6	
3440353	Dosatron International	06/04/2017	3440353	17715176.8	French
3440406	Defendi Italy S.r.l.	03/04/2017	3440406	17720573.9	
3440408	BSH Hausgeräte GmbH	10/03/2017	3440408	17710234.0	German

3440735	TMT Tapping-Measuring-Technology GmbH	07/04/2016	3440735	16718612.1	German
3440774	Xilinx, Inc.	06/04/2017	3440774	17718759.8	
3441127	L'AIR LIQUIDE, SOCIÉTÉ ANONYME POUR L'ÉTUDE ET L'EXPLOITATION DES PROCÉDÉS GEORGES CLAUDE	07/08/2017	3441127	17400049.7	German
3441275	Ninebot (Beijing) Tech Co., Ltd.	30/06/2017	3441275	17819358.7	
3441353	Novadelta-Comércio e Industria de Cafés, Lda.	06/04/2017	3441353	17724126.2	
3441898	Siemens Aktiengesellschaft	10/08/2017	3441898	17185746.9	German
3442382	De'Longhi Appliances S.r.l.	17/05/2017	3442382	17726858.8	
3442387	Mattei, Andrea	17/03/2017	3442387	17721825.2	
3442855	Kayflo Developpement	11/04/2017	3442855	17717390.3	French
3442885	Flexicon Corporation	08/03/2018	3442885	18763239.3	
3442888	Modula S.p.A.	07/04/2017	3442888	17725350.7	
3443033	Covestro Deutschland AG	13/04/2017	3443033	17717696.3	German
3443264	Commissariat à l'Énergie Atomique et aux Énergies Alternatives	27/03/2017	3443264	17717785.4	French
3443707	Accenture Global Solutions Limited GSC Secrypt, LLC	23/05/2017	3443707	17724087.6	
3444091	Reciclopedia, S.L.	10/04/2017	3444091	17720173.8	
3444329	PeCon GmbH	14/08/2017	3444329	17186103.2	German
3444511	Schunk Kohlenstofftechnik GmbH	17/08/2017	3444511	17186640.3	German
3444720	Ricoh Company, Limited	25/07/2018	3444720	18185474.6	
3444994	Telefonaktiebolaget LM Ericsson (publ)	08/05/2013	3444994	18198870.0	
3445006	Hewlett Packard Enterprise Development L.P.	14/08/2018	3445006	18189030.2	
3445100	Huawei Technologies Co., Ltd.	03/05/2016	3445100	16900797.8	
3445608	Italauto Car - Societa' A Responsabilita' Limitata	22/09/2017	3445608	17801496.5	
3445633	KNORR-BREMSE Systeme für Schienenfahrzeuge GmbH	18/04/2017	3445633	17718057.7	German
3445801	Novamont S.p.A.	20/04/2017	3445801	17721970.6	
3445834	Kaivogen Oy	10/03/2017	3445834	17752158.0	
3445909	Enerpaper S.r.l.	22/04/2016	3445909	16727548.6	
3445931	Kiekert AG	24/03/2017	3445931	17718016.3	German

3445939	ARDYNE HOLDINGS LIMITED	20/04/2017	3445939	17729360.2	
3446015	Eisox R&D	20/04/2017	3446015	17717754.0	French
3446196	Microsoft Technology Licensing, LLC	17/04/2017	3446196	17732622.0	
3446221	Microsoft Technology Licensing, LLC	17/04/2017	3446221	17733119.6	
3446337	Karlsruher Institut für Technologie	22/06/2017	3446337	17737474.1	
3446398	Siemens Aktiengesellschaft	05/05/2017	3446398	17723654.4	German
3446489	Telefonaktiebolaget LM Ericsson (publ)	29/07/2016	3446489	16758273.3	
3446596	SEDAC-MECOBEL N.V.	23/08/2018	3446596	18190418.6	
3448288	Orthofix S.r.l.	26/04/2017	3448288	17724759.0	
3448294	Candela Corporation	13/03/2017	3448294	17714068.8	
3448507	Medtronic, Inc.	27/04/2017	3448507	17721948.2	
3448510	Medtronic Inc.	27/04/2017	3448510	17724964.6	
3448644	Fabio Perini S.p.A.	14/04/2017	3448644	17718877.8	
3448744	Baumann s.r.l.	27/04/2017	3448744	17727704.3	
3448770	BERICAP GmbH & CO. KG	13/04/2017	3448770	17717426.5	German
3448919	Soudal	26/04/2017	3448919	17726365.4	
3449080	Royal Boon Edam International B.V.	24/04/2017	3449080	17727970.0	
3449107	Nanni Industries	26/04/2017	3449107	17734245.8	French
3449127	BSH Hausgeräte GmbH	12/04/2017	3449127	17717684.9	German
3449227	Tamtron Oy	27/04/2017	3449227	17720672.9	
3449594	Tolemaica S.r.l.	19/04/2017	3449594	17730266.8	
3449689	JENOPTIK Advanced Systems GmbH	28/04/2017	3449689	17720127.4	German
3450087	A. Narducci S.p.A.	28/08/2018	3450087	18191206.4	
3450158	Miyakoshi Printing Machinery Co., Ltd.	22/08/2018	3450158	18190231.3	
3450319	Airbus Operations GmbH	10/11/2016	3450319	18200783.1	
3450326	Thales	05/09/2017	3450326	17306147.4	French
3450442	Samsung Electronics Co., Ltd.	04/09/2018	3450442	18192427.5	
3450493	SUMITOMO RUBBER INDUSTRIES, LTD.	23/07/2018	3450493	18185075.1	
3450612	Candy S.p.A.	26/07/2018	3450612	18185873.9	
3450880	ALSTOM Transport Technologies	05/09/2018	3450880	18192720.3	French
3451292	Fujitsu Limited	28/04/2016	3451292	16900511.3	
3451358	Schneider Electric Industries SAS	27/08/2018	3451358	18191035.7	French
3451403	Samsung Electronics Co., Ltd.	05/09/2018	3451403	18192792.2	
3451512	Hu, Jiankun	26/04/2016	3451512	16899744.3	
3452212	Stamicarbon B.V.	28/04/2017	3452212	17727404.0	

3452225	Hydro Aluminium Rolled Products GmbH	02/05/2017	3452225	17721622.3	German
3452252	Saint-Gobain Glass France	02/05/2017	3452252	17725321.8	French
3452334	Zhejiang Geely Holding Group Co., Ltd. Zhejiang Geely Automobile Research Institute Co., Ltd.	29/03/2017	3452334	17812425.1	
3452460	Elanco Tiergesundheit AG	28/04/2017	3452460	17722353.4	
3452705	Mahle International GmbH	13/04/2017	3452705	17717707.8	German
3452826	Smiths Medical International Limited	17/03/2017	3452826	17713755.1	
3453463	IOT - Innovative Oberflächentechnologien GmbH	26/06/2018	3453463	18020282.2	German
3454068	Bruker Switzerland AG	29/08/2018	3454068	18191445.8	German
3454838	Adamed Pharma S.A.	07/05/2017	3454838	17723657.7	
3454989	GILSON SAS	10/05/2017	3454989	17721739.5	French
3455047	Marna Engineering AS	12/05/2017	3455047	17731282.4	
3455388	Corning Incorporated	12/05/2017	3455388	17727981.7	
3455889	Cambridge Display Technology Limited Sumitomo Chemical Co., Ltd.	27/04/2017	3455889	17722137.1	
3456091	Telefonaktiebolaget LM Ericsson (PUBL)	13/05/2016	3456091	16723102.6	
3456479	Metabowerke GmbH	28/08/2018	3456479	18191169.4	German
3456556	Hübner GmbH & Co. KG	04/09/2018	3456556	18192375.6	German
3456603	ALSTOM Transport Technologies	18/09/2018	3456603	18195216.9	French
3456789	3D Systems, Incorporated	26/08/2015	3456789	18193770.7	
3457035	IQAir AG	15/09/2017	3457035	17191243.9	German
3457887	S.G.A. Snc Dei F.Lli Spizzi Maria Paola e Abramo & C.	16/12/2016	3457887	16843273.0	
3457966	Orthofix S.r.l.	18/05/2017	3457966	17730675.0	
3458314	Piaggio & C. SpA	11/05/2017	3458314	17727710.0	
3459173	Rosenberger Hochfrequenztechnik GmbH & Co. KG	20/11/2017	3459173	17805153.8	German
3459718	Bell Helicopter Textron Inc.	15/11/2017	3459718	17201978.8	
3459823	NSK Ltd.	22/08/2017	3459823	17843588.9	
3460036	Sartorius Stedim Biotech GmbH	22/09/2017	3460036	17290122.5	
3460422	Griptech b.v.	21/09/2018	3460422	18195853.9	

3461055	Fundación Centro Tecnoloxico de Telecomunicacions de Galicia Universidad de Vigo	20/09/2017	3461055	17382624.9	
3461366	Shya Hsin Packaging Industry (China) Co., Ltd.	03/11/2016	3461366	16906117.3	
3462139	Itron, Inc.	19/12/2016	3462139	18197819.8	
3462524	Commissariat à l'énergie atomique et aux énergies alternatives	28/09/2018	3462524	18197460.1	French
3462638	ViaSat Inc.	18/11/2009	3462638	18201343.3	
3463769	Koninklijke Philips N.V.	26/05/2017	3463769	17726118.7	
3464512	Shell Internationale Research Maatschappij B.V.	23/05/2017	3464512	17727156.6	
3464576	Valent BioSciences LLC	02/06/2017	3464576	17807536.2	
3464716	Voith Patent GmbH	29/05/2017	3464716	17725974.4	German
3464780	Red Dirt Innovations, LLC	26/05/2017	3464780	17807293.0	
3464852	MCE 5 Development Rabhi, Vianney	16/05/2017	3464852	17730845.9	French
3464894	Flender GmbH	02/08/2017	3464894	17748728.7	German
3465782	Luxembourg Institute of Science and Technology (LIST)	16/05/2017	3465782	17725554.4	
3465785	Koninklijke Philips N.V.	07/06/2017	3465785	17731492.9	
3465849	Rosenberger Hochfrequenztechnik GmbH & Co. KG	11/04/2017	3465849	17721523.3	German
3466313	Bissell Homecare, Inc.	02/10/2018	3466313	18198219.0	
3466506	Dongguan Silverlit Toys Co., Ltd.	21/09/2018	3466506	18196000.6	
3466516	Fluytec, S.A.	17/05/2017	3466516	17805920.0	
3466731	Navantia S.A.	31/05/2017	3466731	17734377.9	
3467219	Fina Segura, José Ma	22/05/2017	3467219	17802245.5	
3467558	Corning Optical Communications LLC	09/10/2013	3467558	18194620.3	
3467847	AutoNetworks Technologies, Ltd. Sumitomo Wiring Systems, Ltd. Sumitomo Electric Industries, Ltd.	30/05/2017	3467847	17806649.4	
3468372	Marel Further Processing B.V.	06/06/2017	3468372	17732250.0	
3468974	Vernalis (R&D) Limited Les Laboratoires Servier	09/06/2017	3468974	17727927.0	
3469181	Mare Beheer B.V.	07/06/2017	3469181	17732253.4	
3469620	Robert Bosch GmbH	23/05/2017	3469620	17725260.8	German

3470409	Genfleet Therapeutics (Shanghai) Inc. Medshine Discovery Inc.	08/06/2017	3470409	17812617.3	
3470519	The Broad Institute, Inc. Massachusetts Institute Of Technology President and Fellows of Harvard College	17/06/2016	3470519	18186003.2	
3471930	Koninklijke Philips N.V.	12/06/2017	3471930	17729121.8	
3472411	Nexus Eco Holdings Ltd	20/06/2017	3472411	17737017.8	
3472483	Scuola Superiore di Studi Universitari e di Perfezionamento Sant'Anna	14/06/2017	3472483	17733903.3	
3472668	H.E.F. Université Jean Monnet de Saint- Etienne Centre National de la Recherche Scientifique CNRS	21/06/2017	3472668	17737336.2	French
3472669	Université Jean Monnet Saint Etienne H.E.F. Centre National de la Recherche Scientifique CNRS	21/06/2017	3472669	17737337.0	French
3472974	Samsung Electronics Co., Ltd.	28/12/2016	3472974	16911733.0	
3473457	VDL Weweler B. V.	11/10/2018	3473457	18199832.9	
3473590	Sidel Participations	19/10/2017	3473590	17306419.7	
3473733	SMS Group GmbH	30/08/2018	3473733	18191604.0	German
3473959	Martin Christ Gefriertrocknungsanlagen GmbH	20/10/2017	3473959	17197514.7	German
3474083	Seiko Epson Corporation	21/09/2018	3474083	18195948.7	
3474391	Telsonic Holding AG	20/10/2017	3474391	17197426.4	German
3474620	Sun Patent Trust	13/06/2011	3474620	18210420.8	
3475760	Google LLC	01/12/2017	3475760	17825661.6	
3476503	EVG Entwicklungs- u. Verwertungs- Gesellschaft m.b.H.	02/08/2018	3476503	18000640.5	German
3476586	Goodrich Corporation	24/10/2018	3476586	18202299.6	
3476797	Honeywell International Inc.	31/10/2017	3476797	17199488.2	
3477439	Shenzhen Goodix Technology Co., Ltd.	27/12/2017	3477439	17906782.2	
3477952	Christie Digital Systems USA, Inc.	24/10/2018	3477952	18202249.1	
3478252	L'Oréal	23/06/2017	3478252	17733801.9	
3478253	L'Oréal	23/06/2017	3478253	17735414.9	

3479440	Arçelik Anonim Sirketi	01/07/2016	3479440	16741247.7	
3480068	Doga S.A.	07/11/2017	3480068	17382743.7	
3480352	Reifenhäuser GmbH & Co. KG Maschinenfabrik	10/03/2016	3480352	18206141.6	German
3481667	Brose Fahrzeugteile GmbH & Co. Kommanditgesellschaft, Coburg	11/12/2017	3481667	17811585.3	German
3482148	NOVARES France	03/07/2017	3482148	17745813.0	French
3482170	F. Hoffmann-La Roche AG	07/07/2017	3482170	17735566.6	
3482993	LG Electronics Inc.	28/12/2017	3482993	17210889.6	
3483396	SAFRAN AIRCRAFT ENGINES	08/11/2018	3483396	18205071.6	French
3483645	Samsung Electronics Co., Ltd.	02/10/2015	3483645	18209917.6	
3484245	Tokuden Co., Ltd.	09/11/2018	3484245	18205493.2	
3484463	The United States of America, as Represented by The Secretary, Department of Health and Human Services Office of Technology Transfer	10/08/2017	3484463	17757972.9	
3484566	Drägerwerk AG & Co. KGaA	13/07/2017	3484566	17740293.0	German
3484691	Additive Industries B.V.	13/07/2017	3484691	17742575.8	
3486044	Warein	14/11/2018	3486044	18206131.7	French
3488688	Yaita Seisakusho Co., Ltd.	28/11/2017	3488688	17204127.9	
3488907	Spin Master Ltd.	14/12/2017	3488907	17207495.7	
3489475	C.R.F. Società Consortile per Azioni	27/11/2017	3489475	17203737.6	
3489514	Mitsubishi Heavy Industries, Ltd.	15/08/2017	3489514	17841518.8	
3489518	PFEIFFER VACUUM GMBH	28/11/2017	3489518	17203998.4	German
3490334	FUJITSU LIMITED	27/01/2015	3490334	19150165.9	
3490666	Medtronic Inc.	28/07/2017	3490666	17751530.1	
3490954	Evonik Operations GmbH	13/07/2017	3490954	17737829.6	German
3491347	Bühler AG	27/07/2017	3491347	17742766.3	German
3491975	Conex Digital LLC	01/12/2017	3491975	17204890.2	
3492233	Teijin Limited	27/07/2017	3492233	17834490.9	
3493377	TOYOTA JIDOSHA KABUSHIKI KAISHA	11/10/2018	3493377	18199944.2	
3493537	JVC Kenwood Corporation	31/10/2017	3493537	17898899.4	
3495539	Pai Lung Machinery Mill Co., Ltd.	11/12/2017	3495539	17206372.9	
3496468	Deutsche Telekom AG	08/12/2017	3496468	17206095.6	
3497706	Koninklijke Philips N.V.	08/11/2017	3497706	17801029.4	
3498088	SWISS KRONO Tec AG	12/03/2018	3498088	18161207.8	German

3498137	Jipa CZ s.r.o.	13/12/2018	3498137	18466006.6	
3499029	Siemens Gamesa Renewable Energy A/S	13/12/2017	3499029	17207091.4	
3499594	Seiko Epson Corporation	12/12/2018	3499594	18212093.1	
3499602	Commissariat à l'Energie Atomique et aux Energies Alternatives	12/12/2018	3499602	18212032.9	French
3499603	Commissariat à l'Energie Atomique et aux Energies Alternatives	12/12/2018	3499603	18212072.5	French
3500792	Signify Holding B.V.	18/12/2017	3500792	17816839.9	
3500968	Telefonaktiebolaget LM Ericsson (publ)	18/08/2016	3500968	16763580.4	
3501828	Koh Young Technology Inc.	22/12/2017	3501828	17210425.9	
3502082	Evonik Operations GmbH	21/12/2017	3502082	17209307.2	German
3502084	Evonik Operations GmbH	21/12/2017	3502084	17209336.1	German
3502177	Borealis AG	20/12/2017	3502177	17208801.5	
3503028	Axis AB	21/12/2017	3503028	17209245.4	
3506383	Samsung SDI Co., Ltd.	28/12/2017	3506383	17210814.4	
3507467	Federal-Mogul Valvetrain GmbH	21/02/2017	3507467	17706252.8	
3508723	Daikin Industries, Ltd.	28/06/2017	3508723	17845862.6	
3509374	Sun Patent Trust	02/11/2011	3509374	19159250.0	
3509381	Telefonaktiebolaget LM Ericsson (publ)	12/05/2015	3509381	19159857.2	
3509406	Quanta Computer Inc.	14/11/2018	3509406	18206223.2	
3510226	Lock Antriebstechnik GmbH	19/10/2017	3510226	17787173.8	German
3511240	SAFRAN AIRCRAFT ENGINES	09/01/2019	3511240	19150891.0	French
3512603	Unilever PLC	11/10/2017	3512603	17780136.2	
3512671	Koninklijke Philips N.V.	28/09/2018	3512671	18778487.1	
3513604	Telefonaktiebolaget LM Ericsson (publ)	17/12/2018	3513604	18825656.4	
3513684	Cefla S.C.	15/01/2019	3513684	19151759.8	
3515347	Koninklijke Philips N.V.	18/09/2017	3515347	17769045.0	
3517573	Nanogate SE	24/01/2019	3517573	19153425.4	
3520084	Siemens Industry Software Inc.	31/10/2016	3520084	16795494.0	
3520682	Iglesias Alvarez, Maria	22/09/2017	3520682	17800560.9	
3521152	TIANCHEN BICYCLE-PARTS (SHENZHEN) CO., LTD. A-FORGE ENTERPRISE CO., LTD.	26/07/2018	3521152	18185714.5	
3522152	Sony Corporation	30/06/2017	3522152	17855330.1	
3523457	Kobus SAS	29/09/2017	3523457	17784580.7	French
3523927	Beckhoff Automation GmbH	17/11/2017	3523927	17804840.1	German

3523942	Google LLC	08/12/2017	3523942	17825684.8	
3524104	Novadelta-Comércio e Industria de Cafés, Lda.	28/09/2017	3524104	17792222.6	
3525682	C.R. Bard, Inc.	20/12/2017	3525682	17829512.7	
3525967	Ezu-Metallwaren GmbH & Co. KG	11/09/2017	3525967	17771367.4	German
3526653	Google LLC	24/10/2017	3526653	17795143.1	
3527885	Insta GmbH	06/11/2018	3527885	18204588.0	German
3529845	University of Cape Town	18/10/2017	3529845	17800609.4	
3530715	NICHIA CORPORATION	29/09/2015	3530715	19163048.2	
3530896	Advanced Technology Emission Solutions Inc.	16/07/2018	3530896	18183781.6	
3530995	Mitsubishi Heavy Industries, Ltd.	12/06/2018	3530995	18177350.8	
3531083	MediaTek Inc.	21/02/2019	3531083	19158508.2	
3531921	Koninklijke Philips N.V.	25/10/2017	3531921	17808775.5	
3533215	Baum, Wolfgang	04/12/2017	3533215	17832735.9	German
3534291	Sick AG	01/03/2018	3534291	18159349.2	German
3534587	Deutsche Telekom AG	28/02/2018	3534587	18159124.9	
3535338	Wacker Chemie AG	29/06/2017	3535338	17737512.8	German
3535693	Actuator Solutions GmbH	06/12/2018	3535693	18827252.0	
3539009	Google LLC	22/05/2017	3539009	17729591.2	
3541489	Hamrick, Edward Brian	20/02/2018	3541489	18708302.7	
3545598	Google LLC	05/09/2017	3545598	17767972.7	
3548873	Ceské vysoké učené technické v Praze	29/11/2017	3548873	17828641.5	
3549592	4D Pharma Research Limited	15/06/2016	3549592	19170925.2	
3554253	Unilever PLC	17/11/2017	3554253	17800847.0	
3555491	Vibracoustic AG	30/05/2018	3555491	18729085.3	German
3556981	Hydro Extruded Solutions AS	19/04/2018	3556981	18168357.4	French
3557735	Aumann Espelkamp GmbH	19/04/2018	3557735	18168330.1	German
3560235	Telefonaktiebolaget LM Ericsson (publ)	20/12/2016	3560235	16816687.4	
3562603	Austria Metall GmbH	22/03/2019	3562603	19718254.6	German
3565670	Kleemann GmbH	24/01/2019	3565670	19703956.3	German
3590676	Maucher Formenbau GmbH & Co. KG	07/03/2016	3590676	19187499.9	German

Withdrawn – Section 33(1)

- S20180134 A linkage system comprising an apparatus mountable on agricultural equipment with two or more latching mechanisms to connect to agricultural vehicle. GEOFF MCKEMEY
- 20180305 Boxing bag device that mimics the activity of a real sparring partner.. MARK JAMES
- 20190187 Int. Cl. (2020.01)A61F 11/00; A61B 17/00; A61M 1/00; A61M 39/00. A tympanic membrane therapeutic device. AVENTAMED DESIGNATED ACTIVITY COMPANY
-

Applications Lapsed Through Non-Payment of Renewal Fees Section (35) 1

- 20170131 Int. Cl. (2020.01) E04B 5/00; E04F 15/00. Suspended flooring system. MOULDED FOAMS LIMITED
-

Patents Lapsed Through Non-Payment of Renewal Fees

Please note that due to the high volume of lapsed patents (mostly European Patents designating the State which are not subsequently validated), details of these patents are no longer included in the printed version of the Journal. Instead, they are available to view on the online version of the journal at <https://www.ipoi.gov.ie/en/ip-search-tools/search-the-journal/>

Patents Expired

- 82366 Int. Cl. (2020.01) **G06F 12/06**. Method and apparatus for determining the drive letter assignment of a CD-ROM drive during initial system setup of a computer system. DELL USA, L.P.
- 82463 Int. Cl. (2020.01) **G06F 9/445**. Recoverable software installation process and apparatus for a computer system. DELL USA, L.P.
- 82612 Int. Cl. (2020.01) **G06F 17/30; G06F 3/00; H04L 9/32**. System and method for identification and streamlined access to online services. DELL USA L.P.
- 82613 Int. Cl. (2020.01) **G06F 9/445**. System and method for initiating operation of a computer system. DELL USA L.P.
- S85655 Int. Cl. (2020.01) **G09B 23/00**. Renewable energy based solar hydrogen fuel cell. JOSEPH M. SALEH
- S85665 Int. Cl. (2020.01) **A01J 5/00; G01N 11/00; G01N 9/00; G01N 33/02**. A method of estimating somatic cell count of milk. LIAM MCCARTY; JOHN O'CALLAGHAN
- S85669 Int. Cl. (2020.01) **G06F 17/21; G06F 3/048**. A page rendering method for a small form factor device. Capita plc
- 1020232 Nozzle cap for trigger sprayer. CALMAR INC.
- 1020267 Dryer control system for a gypsum board production line. BPB Canada Inc.
- 1020278 Method for manufacturing laminated rubber member and laminated rubber member produced thereby. DAIKYO SEIKO, LTD.
- 1022017 Cosmetic or pharmaceutical compositions for topical administration with improved stability. STADA ARZNEIMITTEL AG
- 1022053 Mixer. S & W Process Engineering Limited
- 1022054 Mixer, especially for foodstuffs. S & W Process Engineering Limited
- 1022131 Low-noise stretch film. Mima Films s.c.a.
- 1022301 Essentially colorless, transparent polyimide coatings and films. I.S.T. Corporation
- 1022514 Method and device for controlling the gaseous fuel flow. GDF SUEZ
- 1022923 METHOD FOR COLLECTING AND PROCESSING OF TELEMATIC TRAFFIC DATA. T-Mobile Deutschland GmbH
- 1023879 Implantable medical device with enhanced biocompatibility and biostability. MEDTRONIC, INC.
-

- 1023979 Compression molding die assembly for rubber members and rubber member produced thereby. DAIKYO SEIKO, LTD.
- 1024545 Secondary electrochemical generators with zinc anode. Chilwee Power Co. Ltd
- 1027888 Osmotic system for delivery of solid amorphous dispersions of drugs. Bend Research, Inc.
- 1028115 Purification of lipstatin. Cheplapharm Arzneimittel GmbH
- 1028529 Synchronized data capturing circuits using reduced voltage levels and methods therefor. International Business Machines Corporation; Infineon Technologies AG
- 1031909 A system and method for manipulating a computer file and/or program. DMT Licensing, LLC
- 1035523 Refunding-lock for transport trolley. Horst Sonnendorfer; Franz Wieth
- 1038430 Motion transmission for lawn mower. GGP Italy S.p.A.
- 1039203 A pipe coupling. CRANE LIMITED
- 1048274 Shoulder prosthesis with humeral fracture stem. DEPUY ORTHOPAEDICS, INC.
- 1061805 REGULATION OF ENDOGENOUS GENE EXPRESSION IN CELLS USING ZINC FINGER PROTEINS. Sangamo BioSciences, Inc.
- 1061900 DERMAL COMPOSITIONS. NOVEN PHARMACEUTICALS, INC.; Houze, David; Mantelle, Juan; Kanios, David
- 1064808 METHOD FOR AUTOMATICALLY DESIGNING CELLULAR MOBILE RADIOTELEPHONE NETWORKS. T-Mobile Deutschland GmbH
- 1066121 SCREENING DEVICE. Extec Screens and Crushers Limited
- 1066628 RECORD CARRIER AND APPARATUS FOR SCANNING THE RECORD CARRIER. Koninklijke Philips Electronics N.V.
- 1073512 METHOD AND DEVICE FOR PRODUCING SOLID PARTICLES FROM A LIQUID MEDIUM. Vorlop, Klaus-Dieter
- 1075540 SELECTION OF SITES FOR TARGETING BY ZINC FINGER PROTEINS AND METHODS OF DESIGNING ZINC FINGER PROTEINS TO BIND TO PRESELECTED SITES. Sangamo BioSciences, Inc.
- 1114982 Angle transducer system. Contelec AG
- 1116721 Process for the reduction of pterines. Cerbios-Pharma S.A.
- 1118398 Guiding device for a laser marking arrangement. Rexam Aktiebolag
- 1118817 Gas range. Tekno-Lam S.A.
-

- 1120088 An embolization device introducer. William Cook Europe ApS; Cook Incorporated
- 1120094 A delivery catheter for a self-expandable prosthesis. William Cook Europe ApS; Cook Incorporated
- 1120127 Catheter made of a multifilar row of wires. WILLIAM COOK EUROPE ApS; Cook Incorporated
- 1120128 A catheter system. Cook Incorporated; William Cook Europe ApS
- 1123772 Laser unit for marking the surface of a metal strip. Rexam Aktiebolag
- 1140145 NOVEL EXENDIN AGONIST FORMULATIONS AND METHODS OF ADMINISTRATION THEREOF. Amylin Pharmaceuticals, LLC; AstraZeneca Pharmaceuticals LP
- 1140309 A BUILDING ELEMENT FOR A TOY BUILDING SET. LEGO A/S
- 1140310 TOY BUILDING SET WITH INTERCONNECTION BY MEANS OF TENONS WITH SNAP. LEGO A/S
- 1140840 -G(V)-CARBOXYARYL SUBSTITUTED DIPHENYL UREAS AS RAF KINASE INHIBITORS. Bayer HealthCare LLC
- 1140936 TRICYCLIC INHIBITORS OF POLY(ADP-RIBOSE) POLYMERASES. AGOURON PHARMACEUTICALS, INC.; Cancer Research Technology Limited
- 1141014 INSULIN-LIKE GROWTH FACTOR (IGF) I MUTANT VARIANT. Genentech, Inc.
- 1141015 INSULIN-LIKE GROWTH FACTOR (IGF) I MUTANT VARIANTS. Genentech, Inc.
- 1141235 (BIFIDOBACTERIUM) IN THE TREATMENT OF INFLAMMATORY DISEASE. Enterprise Ireland (trading as BioResearch Ireland); University College Cork-National University of Ireland, Cork
- 1141383 METHOD AND POLYNUCLEOTIDES FOR DETERMINING TRANSLATIONAL EFFICIENCY OF A CODON. THE UNIVERSITY OF QUEENSLAND
- 1141385 TARGET MOLECULE ATTACHMENT TO SURFACES. SurModics, Inc.
- 1142905 NOVEL DEPSIPEPTIDE COMPOUND. Astellas Pharma Inc.
- 1143989 EXENDINS FOR GLUCAGON SUPPRESSION. Amylin Pharmaceuticals, LLC; AstraZeneca Pharmaceuticals LP
- 1144015 TREATING PROTEIN-CONTAINING LIQUIDS. Bio Products Laboratory Limited
- 1144045 AN ELECTROTHERAPY DEVICE. Bio-Medical Research Limited
-

- 1144201 SECURITY DOCUMENT WITH A PERFORATION PATTERN.
INDUSTRIAL AUTOMATION INTEGRATORS (IAI) B.V.; SDU
Identification B.V.
- 1144428 METHOD FOR PREPARING AN AZA-MACROLIDE WITH 4"(R)-
NH₂. MERIAL
- 1144668 PROCESS FOR PURIFYING HIGH MOLECULAR WEIGHT
HYALURONIC ACID. TRB CHEMEDICA SA
- 1145011 COMPOSITIONS AND METHODS FOR THE DIAGNOSIS AND
TREATMENT OF TUMOR. Genentech, Inc.
- 1145473 METHOD, SYSTEM, DEVICE FOR PROVING THE AUTHENTICITY
OF AN ENTITY AND/OR THE INTEGRITY AND/OR THE
AUTHENTICITY OF A MESSAGE USING SPECIFIC PRIME
FACTORS. Callahan Cellular L.L.C.
- 1146863 LYOPHILISATES WITH IMPROVED RECONSTITUTIBILITY.
MERCK PATENT GmbH
- 1146864 PH INDEPENDENT EXTENDED RELEASE PHARMACEUTICAL
FORMULATION. BGP Products Operations GmbH
- 1146877 (2-IMIDAZOLIN-2-YLAMINO) QUINOXALINES FOR THE
TREATMENT OF NEURAL INJURY. ALLERGAN, INC.
- 1147075 METHOD FOR PRODUCING L-PHENYLEPHRINE
HYDROCHLORIDE. Boehringer Ingelheim Pharma GmbH & Co.KG
- 1147117 IMMUNOLOGICAL ADJUVANT COMPOUNDS. EISAI R&D
MANAGEMENT CO., LTD.
- 1147200 CAMPYLOBACTER GLYCOSYLTRANSFERASES FOR
BIOSYNTHESIS OF GANGLIOSIDES AND GANGLIOSIDE MIMICS.
NATIONAL RESEARCH COUNCIL OF CANADA
- 1147646 A PORTABLE TELECOMMUNICATION APPARATUS FOR
MULTIPLE AUDIO ACCESSORIES. Telefonaktiebolaget LM Ericsson
(publ)
- 1147879 COMPRESSING MALLET WITH COATING TREATMENT. Takeda
Pharmaceutical Company Limited
- 1148779 EXPRESSION OF SECRETED HUMAN ALPHA-FETOPROTEIN IN
TRANSGENIC ANIMALS. Alpha Cancer Technologies Inc
- 1148839 WOVEN BIFURCATED AND TRIFURCATED STENTS AND
METHODS FOR MAKING THE SAME. BOARD OF REGENTS, THE
UNIVERSITY OF TEXAS SYSTEM
-

- 1148988 THIN-WALLED ELASTIC SHEATH FROM AN ELASTOMERIC MATERIAL. Vision Sciences, Inc.
- 1149065 METHOD FOR THE PRODUCTION OF ESTERS. BASF AKTIENGESELLSCHAFT
- 1149082 PROCESS FOR PREPARING PESTICIDAL INTERMEDIATES. BASF Agro B.V., Arnhem (NL), Wädenswil-Branch
- 1149163 CHROMATOGRAPHIC METHOD FOR PURIFICATION OF ALBUMIN. Albumedix Ltd
- 1149225 METHOD FOR CREATING SECONDARY SIDETRACKS IN A WELL SYSTEM. SHELL INTERNATIONALE RESEARCH MAATSCHAPPIJ B.V.
- 1150620 OSTEOPHILIC IMPLANTS. Straumann Holding AG
- 1150712 HUMAN PAPILLOMA VIRUS VACCINE FORMULATIONS. Merck Sharp & Dohme Corp.
- 1151143 SELECTION OF PROTEINS USING RNA-PROTEIN FUSIONS. THE GENERAL HOSPITAL CORPORATION
- 1151304 METHOD OF IDENTIFYING N-TERMINAL proBNP. Roche Diagnostics GmbH
- 1151591 DATA ACCESS AND MANAGEMENT SYSTEM AND DATA ACCESS AND MANAGEMENT METHOD FOR A COMPUTER SYSTEM. Gailer, Peter; Binzinger, Thomas; Günster, Joachim
- 1152690 AUTOMATIC LUNG PARAMETER ESTIMATOR. Mermaid Care A/S
- 1152783 MEDICAMENT DISPENSER. Ferring International Center S.A.
- 1152947 PACKAGING COMPRISED OF A FOIL-SHAPED COMPOSITE MATERIAL AND METHOD FOR PRODUCING SAID PACKAGING. Alcan Technology & Management AG
- 1152986 SCALE AND/OR CORROSION INHIBITING COMPOSITION. SOLENIS TECHNOLOGIES CAYMAN, L.P.
- 1153129 METHOD OF TREATING RESTENOSIS BY ANTISENSE TARGETING OF C-MYC. AVI BioPharma, Inc.
- 1153304 CURRENT PROBE AND ELECTRICAL ENERGY METER. SUPARULES LIMITED
- 1153481 METHOD AND DEVICE FOR GENERATING A DATA FLOW FROM VARIABLE-LENGTH CODE WORDS AND A METHOD AND DEVICE FOR READING A DATA FLOW FROM VARIABLE-LENGTH CODE WORDS. Fraunhofer-Gesellschaft zur Förderung der angewandten Forschung e.V.
-

- 1154757 FAST DISPERSING DOSAGE FORMS FREE OF GELATIN. Catalent Pharma Solutions, Inc.
- 1154770 PARENTERAL FORMULATION OF PIPERACILLIN. Baxter International Inc.
- 1155310 DISPOSABLE TEST STRIPS WITH INTEGRATED REAGENT/BLOOD SEPARATION LAYER. LifeScan Scotland Limited
- 1155366 TECHNIQUES FOR PERMITTING ACCESS ACROSS A CONTEXT BARRIER ON A SMALL FOOTPRINT DEVICE USING AN ENTRY POINT OBJECT. ORACLE AMERICA, INC.
- 1155498 DEVICE AND METHOD FOR GENERATING A DATA FLOW AND DEVICE AND METHOD FOR READING A DATA FLOW. Fraunhofer-Gesellschaft zur Förderung der angewandten Forschung e.V.
- 1157037 GCSF CONJUGATES. F. Hoffmann-La Roche AG
- 1159487 ABSORBENT PAPER PRODUCT COMPRISING TWO OR THREE PLIES. Essity Operations France
- 1161256 USE OF NERVE GROWTH FACTOR FOR THE MANUFACTURE OF A MEDICAMENT FOR THERAPY OF INTRAOCULAR TISSUE PATHOLOGIES. Dompé farmaceutici s.p.a.
- 1161481 OPTICALLY ACTIVE LINEAR POLYMER USED AS LIGAND IN THE PREPARATION OF METALLIC COMPLEXES DESIGNED FOR ASYMMETRIC CATALYSIS. CENTRE NATIONAL DE LA RECHERCHE SCIENTIFIQUE (CNRS); RHODIA CHIMIE
- 1165905 SYNTHETIC PANEL, ESPECIALLY FOR LINING CONCRETE BUILDING COMPONENTS. Alois Gruber GmbH
- 1169380 STABILIZATION OF POLYMERS AFTER EXPOSURE TO OXIDATION. OCCIDENTAL CHEMICAL CORPORATION
- 1171107 USE OF A PHARMACEUTICAL COMPOSITION IN THE MANUFACTURE OF A MEDICAMENT FOR THE TREATMENT OF PATHOLOGICAL CONDITIONS OF THE EYE CAUSED BY BACTERIA, VIRUSES, FUNGI, YEASTS AND PROTOZOA. Dr. GERHARD MANN chem.-pharm. Fabrik GmbH
- 1178808 NON-AQUEOUS PHARMACEUTICAL COMPOSITION FOR DERMAL USE TO TREAT PSORIASIS COMPRISING A VITAMIN D, A CORTICOSTEROID AND A SOLVENT COMPONENT. LEO PHARMA A/S
- 1179106 CAGE FORMER AND CLAMP THEREFOR. Rom Limited
-

- 1181323 BIOMATERIALS FORMED BY NUCLEOPHILIC ADDITION REACTION TO CONJUGATED UNSATURATED GROUPS. Eidgenössische Technische Hochschule Zürich; Universität Zürich
- 1185274 DRUG COMBINATIONS COMPRISING (E)-7-[4-(4-FLUOROPHENYL)-6-ISOPROPYL-2-[METHYL(METHYLSULFONYL)AMINO]PYRIMIDIN-5-YL](3R,5S)-3,5-DIHYDROXYHEPT-6-ENOIC ACID AND AN INHIBITOR, INDUCER OR SUBSTRATE OF P450 ISOENZYME 3A4. AstraZeneca AB; SHIONOGI & CO., LTD.
- 1185548 METHOD FOR DRYING PROTEIN CRYSTALS. Sanofi-Aventis Deutschland GmbH
- 1188492 CLEANING SPONGE ROLLER. AION Co., Ltd.
- 1190316 TECHNIQUES FOR PERMITTING ACCESS ACROSS A CONTEXT BARRIER IN A SMALL FOOTPRINT DEVICE USING GLOBAL DATA STRUCTURES. SUN MICROSYSTEMS, INC.
- 1196662 SEGMENTAL RETAINING WALL SYSTEM. ANCHOR WALL SYSTEMS, INC.
- 1214945 METHOD AND MEDICAMENT FOR INHIBITING THE EXPRESSION OF A DEFINED GENE. Alnylam Europe AG
- 1218046 RETRACTING NEEDLE SYRINGE. Becton Dickinson and Company
- 1254121 PREPARATION OF SULFONAMIDES. F. Hoffmann-La Roche AG
- 1266768 Security document with a perforation pattern. INDUSTRIAL AUTOMATION INTEGRATORS (IAI) B.V.; Sdu Identification B.V.
- 1272177 METHOD AND FORMULATION FOR TREATING RESISTANCE TO ANTIHYPERTENSIVES AND RELATED CONDITIONS. NEURIM PHARMACEUTICALS (1991) LIMITED
- 1314410 Multi layered wound dressing. ConvaTec Technologies Inc.
- 1352975 Selection of sites for targeting by zinc finger proteins and methods of designing zinc fingers proteins to binds to preselected sites. Sangamo BioSciences, Inc.
- 1408484 Enhancing perceptual quality of sbr (spectral band replication) and hfr (high frequency reconstruction) coding methods by adaptive noise-floor addition and noise substitution limiting. Dolby International AB
- 1550719 Doublestranded RNA (dsRNA) for inhibition the expression of a defined gene. Alnylam Europe AG
- 1574169 Woven intravascular devices. Board of Regents, The University of Texas System
-

- 1582178 Woven intravascular devices and methods for making the same and apparatus for delivery of the same. BOARD OF REGENTS, THE UNIVERSITY OF TEXAS SYSTEM
- 1617418 Spectral band replication and high frequency reconstruction audio coding methods and apparatuses using adaptive noise-floor addition and noise substitution limiting. Dolby International AB
- 1642972 Therapeutic uses of BR43X2 soluble receptors. ZymoGenetics, Inc.
- 1690853 Use of omega-carboxyaryl substituted diphenyl ureas as raf kinase inhibitors. Bayer HealthCare LLC
- 1698901 Method for detecting N-terminal proBNP. Roche Diagnostics GmbH
- 1705183 Binding molecules for human factor VIII and factor VIII-like proteins. Dyax Corp.
- 1897546 Combined compositions comprising (E)-7-[4-(4-fluorophenyl)-6-isopropyl-2-[methyl(methylsulfonyl)amino]pyrimidin-5-yl](3r,5s)-3,5-dihydroxyhept-6-enoic acid. AstraZeneca AB; The University Court of The University of Aberdeen
- 1914728 Method and apparatus for decoding a signal using spectral band replication and interpolation of scale factors. Dolby International AB
- 1914729 Apparatus and method for adjusting the spectral envelope of an high frequency reconstructed signal. Dolby International AB
- 2048234 Chromatographic method for purification of albumin. Alumedix Ltd
- 2090582 Binding molecules for human factor VIII and factor VIII-like proteins. Dyax Corp.
- 2258320 Shoulder prosthesis with humeral fracture stem. DEPUY ORTHOPAEDICS, INC.
- 2258321 Shoulder prosthesis with humeral fracture stem. DEPUY ORTHOPAEDICS, INC.
- 2294989 Methods for making woven intravascular devices. BOARD OF REGENTS, THE UNIVERSITY OF TEXAS SYSTEM
- 2298332 BAFF, inhibitors thereof and their use in the modulation of the B-cell response. Biogen MA Inc.; Topotarget Switzerland SA
- 2298791 Binding molecules for human factor VIII and factor VIII-like proteins. Dyax Corp.
- 2301953 Binding molecules for human factor VIII and factor VIII-like proteins. Dyax Corp.
- 2363479 Oligoribonucleotide for inhibiting the expression of a predefined gene. Alnylam Europe AG
-

- 2450043 Pharmaceutical composition for dermal use to treat psoriasis comprising calcipotriol and betamethasone. Leo Pharma A/S
- 2455083 Pharmaceutical composition for dermal use comprising calcipotriol and betamethasone for treating psoriasis. Leo Pharma A/S
- 2915534 Pharmaceutical composition for dermal use to treat psoriasis comprising a vitamin D and a corticosteroid. LEO PHARMA A/S
- 3146969 OINTMENT FOR THE TOPICAL TREATMENT OF PSORIASIS. LEO PHARMA A/S
-

Request for Grant of Supplementary Protection Certificate

The name and address of the requestor follow the number allocated to the request. The date in brackets following the name and address is the date of receipt of the request. The Patent number is that under which the product in respect of which a certificate is sought is, allegedly, protected. Market Authorisation references in respect of the product concerned are also shown.

2020005 WYETH LLC, 235 East 42nd Street, New York NY 10017-5755,
United States of America
(13 February 2020)
Patent No: 3225233; SODIUM CHLORIDE SOLUTION FOR DRUG
RECONSTITUTION
Product: Eftrenonacog alfa or a biosimilar product pursuant to Article
10(4) of Directive 2001/83/EC.
Market Authorisation: Ireland EU/1/16/1098/001 to
EU/1/16/1098/005, 12/05/2016
European Union EU/1/16/1098/001 to EU/1/16/1098/005, 12/05/2016

Supplementary Protection Certificates Granted

The name and address of the grantee follows the number allocated to the application for grant of a certificate; this number applies also to the granted certificate. The date in brackets following the name and address is the date of grant of the certificate. The number of the basic Patent and the title of the invention are followed by the name of the product for which the certificate is granted. Market authorisation references in respect of the product concerned are also shown, followed by the date of expiry of the certificate.

2018033 CHIESI FARMACEUTICI S.p.A., Via Palermo 26/A, 43122 Parma, Italy
(07/02/2020)
Patent No: 2538968; PROCESS FOR PRODUCTION AND PURIFICATION
OF RECOMBINANT LYSOSOMAL ALPHA-MANNOSIDASE
Product: velmanase alfa
Market Authorisation: Ireland EU/1/17/1258, 23/03/2018
Certificate Expires on: 26/03/2033

Supplementary Protection Certificates Rejected

- 2012014** AstraZeneca AB, SE-151 85, Södertälje, Sweden
(24/04/2012)
Patent No: 1261586; CYCLOPROPYL-FUSED PYRROLIDINE-BASED
INHIBITORS OF DIPEPTIDYL PEPTIDASE IV, PROCESSES FOR THEIR
PREPARATION, AND THEIR USE
Product: A combination product of saxagliptin and metformin and
pharmaceutically acceptable salts thereof, including the hydrochloride salts of
saxagliptin and metformin.
Market Authorisation: Ireland EU/1/11/731/001-012, 24/11/2011
Ireland EU/1/11/731/013-014, 27/02/2012
European Union EU/1/11/731/001-012, 24/11/2011
European Union EU/1/11/731/013-014, 27/02/2012
Application rejected under Article 10(2) of Regulation (EC) No. 469/2009
-

Application for Extension of the Duration of a Supplementary Protection Certificate

The name and address of the applicant follow the number allocated to the Supplementary Protection Certificate (SPC). The date in brackets following the name and address is the date of receipt of the application for an extension of the duration of the SPC. The Patent number is that under which the product in respect of which an extension of the duration of the SPC is sought is, allegedly, protected. Market authorisation references in respect of the product concerned are also shown, followed by the original date of expiry of the certificate.

- 2009001** Research Corporation Technologies, Inc., 6440 N. Swan Road, Suite 200,
Tucson, Arizona 85718, United States of America
(10/02/2020)
Patent No: 0888289; ANTICONVULSANT ENANTIOMERIC AMINO ACID
DERIVATIVES
Product: Lacosamide
Market Authorisation: Ireland EU/1/08/470/001-016, 29/08/2008
Original SPC Expiry Date: 16/03/2022
-

Grant of Extension of Duration of a Supplementary Protection Certificate

The name and address of the grantee follows the number allocated to the granted Supplementary Protection Certificate (SPC). The date in brackets following the name and address is the date of grant of the extension of the certificate. The number of the basic patent and the title of the invention are followed by the name of the product for which the certificate was granted. Market authorisation references in respect of the product concerned are also shown, followed by the new date of expiry of the certificate.

2007006 GENENTECH, INC., 1 DNA Way, South San Francisco, California 94080-4990,

United States of America

(26/11/2019)

Patent No: 0973804; ANTI-VEGF ANTIBODIES

Product: Ranibizumab

Market Authorisation: Ireland EU/1/06/374/001, 22/01/2007

Expiry Date of Extension of SPC: 23/07/2022

2010020 NOVARTIS AG, Lichtstrasse 35, 4056 Basel, Switzerland

(25/10/2019)

Patent No: 1294378; THROMBOPOIETIN MIMETICS

Product: Eltrombopag, optionally in the form of a pharmaceutically acceptable salt or solvate (including a hydrate).

Market Authorisation: Ireland EU/1/10/612/001-006, 11/03/2010

European Union EU/1/10/612/001-006, 11/03/2010

Expiry Date of Extension of SPC: 14/09/2025

2012004 HUMAN GENOME SCIENCES, INC., 14200 Shady Grove Road, Rockville,

MD 20850, United States of America

(03/12/2019)

Patent No: 1294769; ANTIBODIES THAT IMMUNOSPECIFICALLY BIND TO BLYS

Product: Belimumab

Market Authorisation: Ireland EU/1/11/700/01-02, 13/07/2011

Expiry Date of Extension of SPC: 14/12/2026

Designs Registered Under The Industrial Designs Act, 2001

23009 25-02 BRIAN MEEHAN, Woodpark, Annaghdown, Co. Galway, H91 AT13, Ireland
IVOR LOFTUS, Woodpark, Annaghdown, Co. Galway, H91 AT13, Ireland
Address for service is c/o BRIAN MEEHAN AND IVOR LOFTUS
c/o Brian Meehan, Woodpark, Annaghdown, Co. Galway H91 AT13, Ireland

Date of Registration: 24 January 2020.

Glazing support structure for Rooflights.



23010 08.08 WIREMAN PTY LIMITED, 102/20 Alfred Street, Milsons Point, 2061, Australia
Address for service is c/o WIREMAN PTY LIMITED c/o Harriet Pearson 2 Shardcroft Avenue Herne Hill London SE24 0DT United Kingdom.

Date of Registration: 16 January 2020.

A tension board of indefinite length for agricultural netting fences.
Australia-18/07/2019

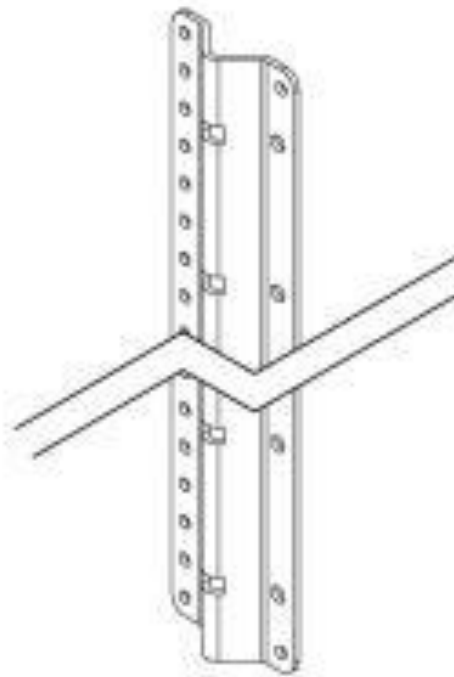

PERSPECTIVE VIEW

23011

25.01

WIREMAN PTY LIMITED, 102/20 Alfred Street, Milsons Point, 2061, Australia

Address for service is c/o WIREMAN PTY LIMITED c/o Harriet Pearson 2 Shardcroft Avenue Herne Hill London SE24 0DT United Kingdom.

Date of Registration: 24 January 2020.

A fence post extension.

Australia-30/08/2019



23012 25.01 WIREMAN PTY LIMITED, 102/20 Alfred Street, Milsons Point, 2061, Australia
Address for service is c/o WIREMAN PTY LIMITED c/o Harriet Pearson 2 Shardcroft Avenue Herne Hill London SE24 0DT United Kingdom.

Date of Registration: 24 January 2020.

A blank for a fence post.
Australia-30/08/2019

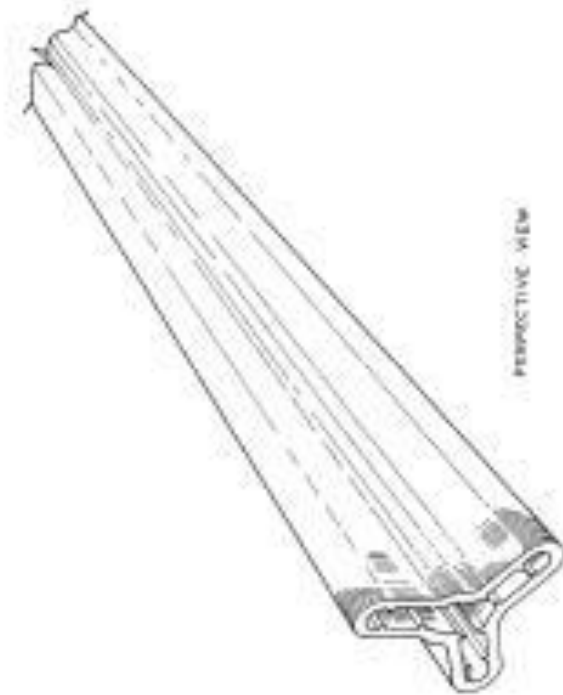

Renewal of Designs Registered under the Industrial Designs Act, 2001

Registrations renewed for 2nd period of 5 Years

Design Number	Class
21877	25-01, 25-02, 25-03
21898	06-01

Registrations renewed for 3rd period of 5 Years

Design Number	Class
21248	23-04
21264	09-09
21265	09-09
21266	09-09
21267	09-09

Designs Registered Under The Industrial Designs Act 2001, which have expired due to non-renewal

Design number	Class
21835	08-06

Iris um Oifig Maoine Intleachtúla na hÉireann
Journal of the Intellectual Property Office of Ireland

Cuid II
Trádmharcanna

No. 2406

Wednesday, 4 March, 2020

NOTE: *The office does not guarantee the accuracy of its publications nor undertake any responsibility for errors or omissions or their consequences.*

In this Part of the Journal, unless the context otherwise requires, a reference to the 1963 Act means the Trade Marks Act, 1963, a reference to the 1963 Rules means the Trade Marks Rules, 1963, a reference to the 1996 Act means the Trade Marks Act, 1996 and a reference to the 1996 Rules means the Trade Marks Rules, 1996.

Official Notice

Patent Rules 1992 – Rule 77 – Office Closure

This Office will be closed to the public on the Tuesday 17th March 2020.

Register of Trade Mark Agents

Examination in Law & practice of Trade Marks

Subject to there being a sufficient number of candidates, it is proposed to hold a written examination in the law and practice of trademarks on **21 April 2020**. The latest date for receipt of applications from persons who wish to sit this written examination is **31 March 2020**.

Candidates wishing to be examined must have submitted in advance to the Controller a completed application form and fee of €200 no later than **31 March 2020**.

Applicants who wish to sit the examination will be notified of the venue and furnished with other relevant information in due course.

Application for Registration of marks published under Section 43(1) of the 1996 Act following acceptance

Notice is hereby given that Applications for the Registration of the undermentioned trade marks have been accepted.

Any person who desires to oppose the registration of these trade marks may within three months from the date of this Journal give notice to the Controller, in accordance with the provisions of Rule 18.

It should be noted that under the provisions of Rule 63(2) no extension of the opposition period is allowed for lodging opposition under Rule 18.

It is desirable before lodging formal opposition that a communication should be addressed to the Applicant affording him an opportunity to withdraw his application for registration. In this way cost of opposition proceedings may be avoided.



260573 13 November 2018

Class 30. Balsamic and honey salad dressing; spiced apple chutney; caramelised onion chutney; honey and mustard salad dressing.

RORY MCCARTHY, 24 Church Street, Cahirciveen, Co. Kerry, Ireland. Address for service is RORY MCCARTHY, c/o CURRAN & CO., Chartered Accountants & Registered Auditors, 6 Georges Quay, Cork, Ireland.



260574 01 December 2018

Class 43. Fast food restaurants; Take-away fast food services.

Piotr Antonow, Mill Road, Killorglin, Co.Kerry, Ireland. Address for service is Piotr Antonow, c/o Apache Pizza, killorglin, Co.Kerry, Ireland.



260587 13 March 2018

- Class 29. Prepared meals and snack foods consisting primarily of potatoes and potato based products, preserved, dried and cooked fruits and vegetables, meat, fish, poultry and game, cheese and cheese mixtures; ingredients for prepared meals and snack foods consisting primarily of potatoes and potato based products, preserved, dried and cooked fruits and vegetables, meat, fish, poultry and game, cheese and cheese mixtures; potato based snacks, french fries, chips and crisps; frozen and chilled foodstuffs all being fruits and/or vegetables; meat, fish, poultry, game, seafood, fruits, vegetables, cheese; prepared foodstuffs and snack foods, all made wholly or predominantly from potatoes and potato based products, preserved, dried and cooked fruits and vegetables, meats, fish, poultry and game, cheese and cheese mixtures; burgers, eggs; milk and milk products; edible oils and edible fats; preserves, jams, jellies, lemon curd; milk shakes; all included in Class 29.
- Class 30. Prepared meals and snack foods consisting primarily of pasta or rice; frozen and chilled foodstuffs all being confectionery, pastries, ices, pasta and/or rice; flour and preparations made from cereals; rice, pasta; cakes,

pastries, gateaux, doughnuts, biscuits; pies, pasties, sausage rolls; ice cream, puddings, confectionery; bread, bread rolls, buns, muffins, crumpets, waffles, sandwiches; sauces, ketchup, mayonnaise, spices, condiments; salad dressings; all included in Class 30.

Class 31. Fresh fruits and vegetables; all included in Class 31.

Class 32. Non-alcoholic beverages; fruit juices, fruit drinks, vegetable juices, smoothies, shakes, mineral waters, aerated and still waters, aerated beverages, concentrated fruit and vegetable juices, syrups for beverages, and beers; and preparations for making all the above beverages, juices, drinks, smoothies, beers.

Class 35. Online, retail and wholesale services relating to the sale of prepared meals and snack foods, preserved, dried and cooked fruits and vegetables, potatoes and potato based products, French fries, chips and crisps, frozen and chilled foodstuffs all being fruits and/or vegetables, prepared meals consisting primarily of pasta or rice, noodle based prepared meals, pizza, pizza toppings, vegetable pies, meat pies, quiches, snack foods, savoury snacks, sausage rolls, pastries, sauces (condiments).

Class 36. Financial sponsorship; charitable fundraising.

Priority Date Claimed: 14 December 2017 United Kingdom

McCain Foods (GB) Limited, Havers Hill, Scarborough, North Yorkshire YO11 3BS, United Kingdom. Address for service is Fiona Gorman, C/O F. F. Gorman & Co, 15 Clanwilliam Square, Dublin 2, Ireland.

The application for registration is proceeding with the consent of the proprietors of Registered European Union Trade Mark No(s). 000070813 and 009948225.

WORDSMITH
Candles

262407 05 December 2019

Class 4. Candles; Candles (Perfumed -); Scented candles; Fragranced candles; Table candles; Tealight candles; Perfumed candles; Candles in tins; Special occasion candles; Candle assemblies; Candle wax; Candle torches; Church candles; Floating candles; Fruit candles; Tallow candles; Nightlights [candles]; Votive candles; Candles for lighting; Musk scented candles; Aromatherapy fragrance candles; Tea light candles; Candles (Christmas tree -); Christmas lights [candles]; Christmas tree candles; Wicks for candles; Candles and wicks for candles for lighting; Candles for absorbing smoke; Candles containing insect repellent; Candles for night lights; Wax for making candles; Grave candles, non-electric; Candles for use as nightlights; Wicks for candles for lighting; Candles and wicks for lighting; Christmas tree decorations for illumination [candles]; Christmas tree ornaments for illumination [candles]; Bougies in the nature of wax candles; Beeswax for use in the manufacture of candles; Candles for use in the decoration of cakes.

Class 21. Candlesticks; Candle snuffers; Candle rings; Candle sticks; Candle holders; Candle extinguishers; Candelabra [candlesticks]; Glass candlesticks; Candle drip rings; Candle jars [holders]; Pillar candle plates; Candlesticks with wind protection; Candlesticks of precious metal; Candle extinguishers of precious metal; Candle holders of wrought iron; Candle holders of precious metal; Candle rings of precious metal; Candle rings, not of precious metal; Non-electric wall sconces [candle holders]; Candle extinguishers, not of precious metal; Candle snuffers, not of precious metal; Candle holders not of precious metal; Candle warmers, electric and non-electric; Candlesticks of glass; Glass holders for candles.

Fiona Reidy, Wood Lodge, Cloverhill Belturbet, Cavan H14AC61, Ireland, Darren Vahey, Wood Lodge, Cloverhill Belturbet, Cavan H14AC61, Ireland. Address for service is c/o Fiona Reidy, Wood Lodge, Cloverhill Belturbet, Cavan H14AC61, Ireland.

GUNPOWDER

262408 30 January 2018

Class 33. Gin.

PJ Rigney, The Food Hub, Carricknabrack Drumshanbo, Co. Leitrim, Ireland. Address for service is c/o JANE FARREN, c/o Eugene F. Collins, Temple Chambers, 3 Burlington Road, Dublin 4, Ireland.

The application for registration is proceeding with the consent of the proprietors of Irish Registered Trade Mark Numbers 253174, 254398 and 258027 and European Union Trade Mark Numbers 014992812, 015515224, 015800477

orbe
ORBE
Orbe

Application is for a Series of 3 Trade Marks.

262409 08 December 2019

Class 3. Eyelashes; Eyelash tint; Artificial eyelashes; Eyelashes (False -); False eyelashes; Eyelashes (Cosmetic preparations for -); Cosmetic preparations for eyelashes; Eyelashes (Adhesives for affixing false -); Adhesives for affixing artificial eyelashes; Adhesives for affixing false eyelashes; Adhesives for false eyelashes, hair and nails.

Priority Date Claimed: 10 September 2019 United Kingdom

Wajahat Abbassi, FLAT 21 ASHLEY COURT, 31 CLYDE ROAD BALLSBRIDGE, DUBLIN D04H761, Ireland. Address for service is c/o Wajahat Abbassi, FLAT 21 ASHLEY COURT, 31 CLYDE ROAD BALLSBRIDGE, DUBLIN D04H761, Ireland.

PICKEX

262410 18 November 2019

Class 19. Non-metallic fencing components inclusive of non-metallic fence posts, non-metallic fence post extensions and extenders, non-metallic fencing fittings, and non-metallic fencing connectors; plastic fences including prefabricated plastic fences.

Priority Date Claimed: 15 July 2019 Australia

WIREMAN PTY LIMITED, 2 SHARDCROFT AVE, HERNE HILL, LONDON SE24 0DT, United Kingdom. Address for service is c/o WIREMAN PTY LIMITED, 2 SHARDCROFT AVE, HERNE HILL, LONDON SE24 0DT, United Kingdom.

VELLA HOMES

262411 12 December 2019

Class 37. Construction; Construction consultancy; Construction services; Building

construction; Residential construction; Commercial construction; Building, construction and demolition; Building maintenance and repair.

VELLA HOMES LIMITED, Springmount Business Centre, Market Square, Mallow, Cork, Ireland. Address for service is c/o David Reilly, Reilly & Co, Solicitors, Bank House, Kent St. Clonakilty, cork P85X922, Ireland.

The mark in use is/will be in the colour(s) Black



The mark consists of a three dimensional shape.

262412 13 December 2019

Class 33. Alcoholic beverages (except beers).

Priority Date Claimed: 18 November 2019 France

MARTELL & Co, Place Edouard Martell, 16100 Cognac, France. Address for service is c/o TOMKINS & CO., 5 Dartmouth Road, Dublin 6, Ireland.



262413 13 December 2019

- Class 9. Software; Training software; Payment software; Business software; Data processing software; Document management software; Data management software; Online payment software; E-payment software; File management software.
- Class 35. Administration of membership schemes.
- Class 45. Reviewing standards and practices to assure compliance with laws and regulations; Vetting services.

ComplySAFE Limited, 38 Fitzwilliam Square, Dublin 2 D02 NX53, Ireland. Address for service is c/o ComplySAFE Limited, 38 Fitzwilliam Square, Dublin 2 D02 NX53, Ireland.

The mark in use is/will be in the colour(s) The colours used will be (i) black colour on the left section of the image which is in the shape of the letter 'C', (ii) red in the main section of the image which is in the shape of a safe with a letter 'E' of the right side, and (iii) white in the space between the black and red colours, in the area of the keyhole and in the spaces within the letter 'E'.

Higher Ground

262414 13 December 2019

Class 41. Education.

Bernadette Cusack, Apartment 2, Montpelier Mews, Montpelier Hill, Dublin D07 Hk72, Ireland. Address for service is c/o Bernadette Cusack, Apartment 2, Montpelier Mews, Montpelier Hill, Dublin D07 HK72, Ireland.

Agrionica Limited, Enterprise & Research Incubation Campus, IT Carlow, Green Rd, Carlow R93T210, Ireland. Address for service is c/o Agrionica Limited, Enterprise & Research Incubation Campus, IT Carlow, Green Rd, Carlow R93T210, Ireland.

The mark in use is/will be in the colour(s) PANTONE 2035 XGC, PANTONE P 115-7 C, PANTONE 19-4004 TCX



262415 13 December 2019

Class 9. Optical apparatus and instruments; Apparatus and instruments for physics; Measuring, detecting, monitoring and controlling devices; Spectrograph apparatus; Computer software applications, downloadable; Software applications for mobile devices; Computer programs, recorded; Computer programs, downloadable; Printed circuit boards; Measuring instruments; Food analysis apparatus.

Class 42. Scientific research; Research in the field of physics; Research and development of new products for others; Scientific consultancy; Technological consultancy; Scientific services and design relating thereto; Research and development of new products; Agricultural research; Research services.

GUNPOWDER GIN

262416 30 January 2018

Class 33. Gin.

PJ Rigney, The Food Hub, Carricknabrack Drumshanbo, Co Leitrim, Ireland. Address for service is c/o JANE FARREN, c/o Eugene F. Collins, Temple Chambers, 3 Burlington Road, Dublin 4, Ireland.

The application for registration is proceeding with the consent of the proprietors of Irish Registered Trade Mark Numbers 253174, 254398 and 258027 and European Union Trade Mark Numbers 014992812, 015515224, 015800477



262417 16 December 2019

Class 19. Trench drains [concrete drainage structures].

Vincent Molloy, Ballynasrah, Ballinamere, Tullamore, Offaly R35 P866, Ireland. Address for service is c/o Vincent Molloy, Ballynasrah, Ballinamere, Tullamore, Offaly R35 P866, Ireland.

The mark in use is/will be in the colour(s) Florite blue: C: 100, M: 90, Y: 0, K: 10 Florite grey: C: 15, M: 0, Y: 0, K: 50

ALLIED IRISH BANK (GB)

262418 16 December 2019

Class 9. Automated banking machines; automated cash machines; cash dispensing machines; cash registers; calculating machines; apparatus for processing card transactions and data relating thereto and for payment processing; apparatus for verifying data on magnetically encoded cards; magnetic cards; magnetically encoded and smart (programmable) cards and stickers; computer hardware and software; data receivers for registration, transfer, processing and reproduction of sounds, images or data; electronically encoded identity wristbands; parts and fittings for the aforesaid goods.

Class 16. Paper, cardboard; printed matter; books, booklets, catalogues, magazines; periodical publications; manuals; travellers' cheques, money orders, money drafts; cheques; cardboard and plastic cards; book binding materials; photographs; stationery; writing instruments; files and folders; document wallets; adhesives

for stationery or household purposes; artists' materials; paint brushes; typewriters and office requisites (except furniture); instructional and teaching material (except apparatus); plastic materials for packaging (not included in other classes); printers' type; printing blocks.

Class 36. Insurance services; financial services; private banking services; monetary affairs; financial management, administration and valuation services; financing and procurement of financing; financial loan advisory services; loan procurement services; mortgage, banking, investment management, trustee and financial advisory services; deposit taking, savings, investment, mortgage and real estate agency services; financial administration services; financing services for securing of funds; pension fund administration; financing services for the securing of funds for others and for the financing and arranging of loans; services for the financing of home loans; valuation of chattels; nominee services; stock broking services; tax services; pension fund services; public and private equity financing; funds transfer services; brokerage agencies for insurance and credit; management of wealth; issuing of traveller cheques; credit card, charge card, cash card, cheque guarantee card, purchase, payment and debit card services; financial planning and investment advisory services; provision of finance, money exchange and money transmission services; real estate appraisals, brokerage, leasing, management and valuations;

real estate selection and acquisition; rent collection; renting and leasing of premises; credit card services; credit, discount and loyalty card services; issuance of tokens of value for use in loyalty schemes; information, advisory and consultancy services relating to the aforementioned services.

Allied Irish Banks PLC, Bankcentre, Ballsbridge, Dublin 4, Ireland. Address for service is c/o FRKelly, 27 Clyde Road, Ballsbridge, Dublin 4, Ireland.



262419 24 August 2018

Class 25. Clothing; footwear; headgear.
 Class 35. Ordering services for third parties; advertising services; promotion services; advertising; banner advertising; radio advertising; advertising and publicity; advertising and marketing; promotion (advertising) of business; advertising services relating to hotels; advertising services for the promotion of e-commerce; advertising, marketing and promotion services; provision of information and advice in relation to the aforementioned

services; none of the aforesaid services relating to television advertising, television or film production and distribution.
 Class 39. Travel arrangement services; arranging and booking of travel for holidays; arranging and booking of tours and excursions; provision and arrangement of transport services between venues and destinations; chauffeur services; transport reservation services; vehicle rental services; provision of information and advice in relation to the aforementioned services; tour guide services; travel guide services; delivery of goods; arrangement of tours.
 Class 41. Special event planning; special event planning consultation; organising of recreational events; organising events for entertainment purposes; entertainment services; recreational services; organization of parties; nightclub services; provision of information and advice in relation to the aforementioned services; none of the aforesaid services relating to television or film production or distribution.

Kate Hyde, Unit M, 2nd Floor, Block 1B, Cleaboy Business Park, Old Kilmeaden Road, Waterford X91 DVY8, Ireland. Address for service is c/o Kate Hyde, Unit M, 2nd Floor, Block 1B, Cleaboy Business Park, Old Kilmeaden Road, Waterford X91 DVY8, Ireland.

The application for registration is proceeding with the consent of the proprietors of Registered EUTM No. 012288940.

The mark in use is/will be in the colour(s) red, black, brown, green

PARODONTAX

262420 04 November 2019

- Class 9. Electrical and computer software; diagnostic equipment; apps for use in connection with medical devices; electronic monitoring devices; electric measuring apparatus; computer monitors; software applications (apps) delivered online or as downloadable applications; software and/or software applications (apps) for medical and/or surgical applications; data collecting systems for medical purposes.
- Class 10. Surgical, medical, dental apparatus and instruments; orthopaedic articles; suture materials; therapeutic and assistive devices adapted for the disabled; massage apparatus; apparatus, devices and articles for nursing infants, diagnostic apparatus for medical purposes; patches for medical use, electromagnetic therapy devices; infrared therapy devices; ultra-sound therapy devices; laser therapy devices.

Stafford-Miller (Ireland) Limited, Clocherane, Youghal Road, Dungarvan, Co. Waterford, Ireland. Address for service is c/o TOMKINS & CO., 5 Dartmouth Road, Dublin 6, Ireland.

The application for registration is proceeding with the consent of the proprietors of Registered EUTM No. 015610058.



Application is for a Series of 2 Trade Marks.

262421 09 January 2019

- Class 41. Entertainment services; Discotheque services; operation of a discotheque, entertainment services provided at discotheques; operation of discotheques for children and teenagers.
- Class 43. Services for providing of food and drink; bar, music bars, café, lounge, catering food and drink services; providing facilities for weddings, parties, dancing, discos and banqueting services.

Michael Wright, Unit 7, Swords Business Park, Swords, County Dublin, Ireland. Address for service is c/o TOMKINS & CO., 5 Dartmouth Road, Dublin 6, Ireland.

The application for registration is proceeding with the consent of the proprietors of pending Irish Trade Mark No's 2017/00964, 2016/00820, 2016/00821 and 2016/02522 and the proprietor of Registered EUTM No. 15286891

The first mark in the series in use is/will be in the colour(s) grey and white.



262422 16 December 2019

Class 41. Education; providing of training; sporting activities; arranging and conducting of workshops and classes (training); coaching (training); conducting fitness classes; physical education; physical fitness instruction; physical fitness consultation; exercise [fitness] advisory services; fitness and exercise instruction; personal trainer services; physical fitness assessment services for training purposes; providing sports facilities; organising and arranging of courses, seminars, training courses and lectures; arranging of workshops; training consultancy and coaching; education services relating to

nutrition; provision of educational health and fitness information; conducting training sessions on physical fitness online; provision of information on fitness training via an online portal.

BFIT4LIFE PERFORMANCE CENTRE LIMITED,
82 Moreen Road, Sandyford, Dublin 16, Ireland.
Address for service is c/o Cruickshank, 8a Sandyford
Business Centre, Sandyford, Dublin 18, Ireland.

The mark in use is/will be in the colour(s) Black, white, red

FIT, FORTY & BEYOND

262423 16 December 2019

Class 41. Education; providing of training; sporting activities; arranging and conducting of workshops; arranging and conducting of classes (training); coaching (training); conducting fitness classes; physical education; physical fitness instruction; physical fitness consultation; exercise [fitness] advisory services; fitness and exercise instruction; personal trainer services; physical fitness assessment services for training purposes; providing sports facilities; organising and arranging of courses, seminars, training courses and lectures; arranging of workshops; training consultancy and coaching; education services relating to nutrition; provision of educational health and fitness information; conducting training sessions on physical

fitness online; provision of information on fitness training via an online portal.

BFIT4LIFE PERFORMANCE CENTRE LIMITED,
82 Moreen Road, Sandyford, Dublin 16, Ireland.
Address for service is c/o Cruickshank, 8a Sandyford
Business Centre, Sandyford, Dublin 18, Ireland.



262424 03 December 2019

- Class 9. Music recordings; Sound recordings; Audio recordings; Recording discs; Recording disks; Musical recordings; Audiovisual recordings; Digital recordings; Strips (Sound recording -); Recording discs [magnetic]; Magnetic recording discs; Recording substrates [optical]; Optical recording media; Recording substrates [magnetic]; Audio recording equipment; Image recording apparatus; Film recording apparatus; Video recordings; Magnetic recordings.
- Class 25. Dresses; Shields (Dress -); Dress pants; Dress shoes; Dress suits; Dress shirts; Dress shields; Shift dresses;

Evening dresses; Cocktail dresses; Wedding dresses; Bridesmaid dresses; Tennis dresses; Nurse dresses; Ladies' dresses; Maternity dresses; Leather dresses; Pinafore dresses; Jumper dresses; Shirts; Sweaters; Polo sweaters; Turtleneck sweaters; Jumpers [sweaters]; V-neck sweaters; Crew neck sweaters; Mock turtleneck sweaters; Jackets; Jacket liners; Suede jackets; Motorcycle jackets; Denim jackets; Heavy jackets; Sweat jackets; Donkey jackets; Long jackets; Sleeved jackets; Sleeveless jackets; Leather jackets; Bed jackets; Socks; Sports socks; Ankle socks; Woollen socks; Tennis socks; Bed socks; Thermal socks; Water socks; Footless socks; Pop socks; Toe socks; Trouser socks; Anklets [socks]; Underwear; Ladies' underwear; Thermal underwear; Long underwear; Women's underwear; Anti-sweat underwear; Boy shorts [underwear]; Underwear (Anti-sweat -); Functional underwear; Trunks [underwear]; Maternity underwear; Knitted underwear; Jockstraps [underwear]; Briefs [underwear]; Disposable underwear; Anti-sweat underclothing; Underclothing (Anti-sweat -); Articles of underclothing; Womens' underclothing; Gussets for underwear [parts of clothing]; Sweat-absorbent underwear; Babies' pants [underwear]; Underwear for women; Men's underwear; Bodies [underclothing]; Teddies [underclothing]; Slips [underclothing]; Underclothing; Sweat-absorbent underclothing; Corsets [underclothing]; Trousers; Casual trousers; Infants' trousers; Over-

- trousers; Rain trousers; Waterproof trousers; Snowboard trousers; Short trousers; Trousers shorts; Golf trousers; Corduroy trousers; Riding trousers; Ski trousers; Leggings [trousers]; Trousers for children; Scarfs; Neck scarfs [mufflers].
- Class 30. Macaroni; Macaroni cheese; Macaroni [uncooked]; Macaroni salad; Macaroni with cheese; Macarons; Chocolate; Chocolates; Filled chocolate; Chocolate chips; Milk chocolate; Dairy chocolate; Chocolate bars; Chocolate shells; Imitation chocolate; Aerated chocolate; Chocolate extracts; Chocolate truffles; Chocolate fondue; Chocolate syrup; Chocolate syrups; Drinking chocolate; Chocolate beverages; Chocolate flavourings; Chocolate powder; Chocolate brownies; Chocolate wafers; Chocolate pastes; Chocolate creams; Chocolate spreads; Chocolate topping; Chocolate sauces; Chocolate cake; Chocolate cakes; Hot chocolate; Chocolate biscuits; Cookies; Cookie dough; Cookie mixes; Fortune cookies; Almond cookies; Frozen cookie dough; Egg roll cookies; Danish butter cookies; Fried dough cookies; Fried dough cookies (karintoh); Korean traditional sweets and cookies [hankwa]; Pastries, cakes, tarts and biscuits (cookies); Tea; Teas; Darjeeling tea; Tea mixtures; Tea substitutes; Artificial tea; Oolong tea [Chinese tea]; Oolong tea; Green tea; Black tea [English tea]; Sage tea; Jasmine tea; Tea essences; Tea cakes; Black tea; Tea (Iced -); Ginseng tea; Rooibos tea; Tea leaves; Mate [tea]; Instant tea; Tea extracts; Chai tea; Tea bags; Coffee; Decaffeinated coffee; Instant coffee; Coffee extracts; Coffee (Unroasted -); Coffee oils; Ground coffee; Muffins; Muffin mixes; English muffins; Cakes; Almond cake; Cake flour; Cake frosting; Powder (Cake -); Breakfast cake; Treacle cake; Cake doughs; Candy cake; Cake mixtures; Cake preparations; Sponge cake; Cake icing; Cake mixes; Pop corn; Kettle corn [popcorn]; Corn (Pop -); Sushi; Pounded rice cakes (mochi); Sweet pounded rice cakes (mochi-gashi); Doughnuts; Doughnut mixes; Instant doughnut mixes; Flour for doughnuts; Baguettes; Fruit jelly candy; Buckwheat jelly (Memilmuk); Confectionery containing jelly; Royal jelly; Jelly beans; Ice; Ices; Fruit ice; Ice milk [ice cream]; Ice confectionery; Ice confections; Ice candies; Ice candy; Ice blocks; Water ice.
- Class 39. Food delivery; Mail delivery; Delivery (Flower -); Pizza delivery; Delivery services; Package delivery; Document delivery; Flower delivery; Message delivery; Delivery of food; Food delivery services; Delivery of vehicles; Delivery of messages; Delivery of fuel; Parcel delivery; Newspaper delivery; Fuel delivery services; Cargo delivery services; Delivery of wines; Nappy delivery services; Parcel delivery services; Delivery of parcels; Delivery of packets; Delivery of correspondence; Correspondence (Delivery of -); Delivery of letters; Letters (Delivery of -); Delivery of groceries; Delivery by road; Delivery of magazines; Delivery of valuables; Delivery of spirits; Delivery of water; Delivery of furniture; Goods (Delivery of -); Delivery of newspapers;

Delivery of goods; Delivery of messages [courier]; Road delivery of parcels; Delivery of gas cookers; Delivery of disposable napkins; Document delivery [hand carried]; Express delivery of freight; Express delivery of goods; Delivery [distribution] of goods; Express delivery of letters; Temporary storage of deliveries; Delivery of parcels by air; Delivery of cargo by air; Delivery of fuel to barges; Delivery of goods by rail; Arranging the delivery of gifts; Delivery of messages by courier; Transportation and delivery of goods; Transport and delivery of goods; Delivery and storage of goods; Storage and delivery of goods; Delivery of parcels by road; Delivery of parcels by land; Delivery of domestic appliance parts; Delivery of parcels by courier; Delivery of food by restaurants; Arranging the delivery of goods; Delivery of goods by messenger; Messenger (Delivery of goods by -); Mail delivery and courier services; Delivery and forwarding of mail; Delivery of mail by courier; Courier services for the delivery packages; Document delivery by non-electronic means; Collection, transport and delivery of goods; Pick-up and delivery of letters; Delivery of goods by mail order; Courier services for the delivery of parcels; Delivery of hampers containing food and drink; Arranging the delivery of goods by post; Courier services for the delivery of goods; Correspondence delivery by post and/or messenger; Delivery and forwarding of letters and parcels; Pick-up and delivery of textile goods; Pickup and delivery of parcels and goods;

Collection, transport and delivery of palletised goods; Delivery of bottled water to homes and offices; Arranging and conducting of mail order delivery services; Delivery of food and drink prepared for consumption; Delivery, despatching and distribution of newspapers and magazines; Cargo delivery services; Delivery of cargo by land.

YU SUNGCIAN, 8 RUE PALERME, 67000 STRASBOURG, France. Address for service is c/o YU SUNGCIAN, 8 RUE PALERME, 67000 STRASBOURG, France.

The mark in use is/will be in the colour(s) purple, orange, brown and grey



Application is for a Series of 3 Trade Marks.

262425 13 December 2019

Class 41. Museums.

Galway City Council, City Hall, College Road, Galway, Ireland. Address for service is c/o Galway City Council, City Hall, College Road, Galway, Ireland.

The mark in use is/will be in the colour(s) Main Colours C93, M60, Y37, K26 Second Colour C70, M0, Y30, K0



262426 16 December 2019

Class 41. Education; Education services; Education information; Information (Education -); Lingual education; Academies [education]; Further education; Educational consultancy; Educational instruction; Educational seminars; Educational information; Educational services; Education and instruction; Education and training; Providing of education; Sports education services; Sporting education services; Physical-education services; Physical education services; Primary education services; Adult education services; Academy education services; Academy services (Education -); Education academy services; Club education services; Higher education services; Team building (education); Online education services; Residential education courses;

Boarding school education; Educational consultancy services; Educational advisory services; Developing educational manuals; Educational institute services; Educational services for providing courses of education; Symposiums relating to education; Training and education services; Education and training services; Provision of education courses; Education, teaching and training; Education, entertainment and sports; Education and training consultancy; Organising of education conferences; Education and instruction services; Educational services provided by institutes of further education; Educational services provided by institutes of higher education; Educational and training services; Organising of educational seminars; Organisation of educational seminars; Educational courses (Provision of -); Organising of educational games; Organising of educational lectures; Workshops for educational purposes; Organising of educational congresses; Organization of educational congresses; Organization of educational symposia; Organising of educational exhibitions; Second language educational services; Organization of educational conferences; Organising of educational conferences; Arranging of educational conferences; Conducting of educational conferences; Education services relating to languages; Provision of facilities for education; Advisory services relating to education; Education services relating to sports; Professional consultancy relating to

education; Provision of education and training; Provision of training and education; Summer camps [entertainment and education]; Linguistic education and training services; Education, entertainment and sport services; Providing facilities for educational purposes; Educational services provided for children; Organisation of continuing educational seminars; Arranging and conducting educational conferences; Exhibition services for educational purposes; Educational services provided by academies; Education academy services for teaching languages; Organisation of seminars relating to education; Arranging of seminars relating to education; Organising of conferences relating to education; Arrangement of conventions for educational purposes; Summer camps [entertainment and education]; Organisation of entertainment activities for summer camps; Organisation of educational activities for summer camps; Organisation of sports activities for summer camps; Organisation of cultural activities for summer camps; Holiday camp services.

Class 43. Catering services for educational establishments; Camp services (Holiday -) [lodging]; Holiday camp services [lodging]; Holiday lodgings; Resort lodging services; Providing temporary lodging at holiday camps; Camp services (Holiday -) [lodging].

Coláiste Chamuis Teoranta, Aille, Indreabhán, Co. na Gaillimhe H91 WA09, Ireland. Address for service is c/o Coláiste Chamuis Teoranta, Aille, Indreabhán, Co. na Gaillimhe H91 WA09, Ireland.



262427 17 December 2019

Class 8. Adhesive spreaders (hand tools); Apparatus for dispensing adhesives (hand tool); Hand operated coating apparatus for use with adhesives; Hand tools (hand operated) for use in applying adhesives; Bits (hand tools); Bits (parts of hand tools); Blades (hand tools); Caulking cutters (hand tools); Cutting inserts for use with hand tools; Cutting tools (hand tools); Edge tools (hand tools); Guns (hand tools); Hand held tools, hand-operated; Hand tools (hand operated) for manual use; Hand tools (hand operated) for use in the building industry; Hand tools, hand-operated; Manually driven hand tools; Paint guards (hand tool); Scrapers (hand tools); Scraping tools (hand tools); Bits for hand-operated implements; Bits for hand-operated tools; Tool bits for hand operated tools; Caulking irons; Non-electric caulking guns; Apparatus (hand-operated) for cutting; Hand tools (hand operated) for cutting; Hand-operated cutting tools; Filler knives; Filling knives; Guns, hand-operated, for the extrusion of mastics;

Hand guns (hand operated) for dispensing injection cartridges; Non-electric glue guns; Cutters (hand operated tools); Hand operated coating apparatus for use with paints; Hand-operated gluing apparatus; Hand-operated mixing tools for paints; Hand-operated mixing tools for varnishes; Hand-operated tools; Tools (hand-operated) for applying paint to surfaces; Hand tools (hand operated) for use by painters (other than brushes); Knives; Knives made of plastic materials; Manually operated apparatus for glue (other than for office use); Manually operated glue dispensers, other than for office use; Apparatus for removing paints (hand operated); Paint shields (hand tool); Painters' knives; Painters' tools (hand operated); Tips for tool bits (parts of hand-operated tools.

Class 16. Brushes for painters; Brushes for the application of paints; Hand held instruments for painting; Hand rollers for applying paint; Hand-rests for painters; House painters' brushes; House painters' roller brushes; House painters' rollers; Instruments for use in painting; Pads for applying paint; Paint applicator pads; Paint applicators; Paint applicators comprising a container and brush; Paint brushes; Paint kettles; Paint pads (applicators); Paint roller trays; Paint rollers for applying paint; Paint scuttles; Paint trays; Paintbrushes; Painters' brushes; Painting apparatus; Painting instruments; Painting materials for use in the application of paint; Rollers for applying paint; Rollers for use by painters; Stipple applicators for use by painters; Trays for painting;

Hand-operated patterning apparatus for applying decorative patterns to walls; Hand-operated patterning apparatus for use by decorators; covers for roller brushes; roller brush frames; extension poles for paint brushes and roller brushes; roller covers; painting accessories; Paintbrushes, including roller brushes; roller; Drip mats of paper; painters drop sheet; painters drop cloth; all of the aforementioned goods relating to home and/or building decoration, not including artists' brushes.

Australian Brushware Corporation Pty Ltd, Level 2, 20 Council Street, Hawthorn East 3123, Australia. Address for service is c/o Australian Brushware Corporation Pty Ltd c/o Hardware Lane Distributors, 500 Avebury Boulevard, MILTON KEYNES MK9 2BE, United Kingdom.

Bottle on Board

262428 12 December 2019

Class 44. Medical Care.

Muintir na Tire, Canon Hayes House, Rosanna Road, Tippetry Town, Co Tipperary, Ireland. Address for service is c/o Muintir na Tire, Canon Hayes House, Rosanna Road, Tippetry Town, Co Tipperary, Ireland.



262429 06 November 2019

- Class 41. Life coaching (training); Training or education services in the field of life coaching.
 Class 44. Hypnotherapy.
 Class 45. Consultancy (Intellectual property -).

Pauline Rohdich, 2 The Demesne, Monivea, Co Galway H65 D542, Ireland. Address for service is c/o Pauline Rohdich, 2 The Demesne, Monivea, Co Galway H65 D542, Ireland.

The mark in use is/will be in the colour(s) Hex #ff5757 and #5ce1e6

DOÑA PAULA UNIQUE

262430 13 December 2019

- Class 33. Wines and sparkling wines

Viña Doña Paula S.A., Avenida Colón 531, piso 2, Mendoza, Argentina. Address for service is c/o ARTHUR COX, 10 Earlsfort Terrace, Dublin 2, DO2 T380, Ireland.

DOÑA PAULA TELMO

262431 13 December 2019

- Class 33. Wines and sparkling wines

Viña Doña Paula S.A., Avenida Colón 531, piso 2, Mendoza, Argentina. Address for service is c/o Arthur Cox, 10 Earlsfort Terrace, Dublin 2, DO2 T380, Ireland.

MONARCH ADVANCE

262432 17 December 2019

- Class 8. Adhesive spreaders (hand tools); Apparatus for dispensing adhesives (hand tool); Hand operated coating apparatus for use with adhesives; Hand tools (hand operated) for use in applying adhesives; Bits (hand tools); Bits (parts of hand tools); Blades (hand tools); Caulking cutters (hand tools); Cutting inserts for use with hand tools; Cutting tools (hand tools); Edge tools (hand tools); Guns (hand tools); Hand held tools, hand-operated; Hand tools (hand operated) for manual use; Hand tools (hand operated) for use in the building industry; Hand tools, hand-operated; Manually driven hand tools; Paint guards (hand tool); Scrapers (hand tools); Scraping tools (hand tools); Bits for hand-operated implements; Bits for hand-operated tools; Tool bits for

hand operated tools; Caulking irons; Non-electric caulking guns; Apparatus (hand-operated) for cutting; Hand tools (hand operated) for cutting; Hand-operated cutting tools; Filler knives; Filling knives; Guns, hand-operated, for the extrusion of mastics; Hand guns (hand operated) for dispensing injection cartridges; Non-electric glue guns; Cutters (hand operated tools); Hand operated coating apparatus for use with paints; Hand-operated gluing apparatus; Hand-operated mixing tools for paints; Hand-operated mixing tools for varnishes; Hand-operated tools; Tools (hand-operated) for applying paint to surfaces; Hand tools (hand operated) for use by decorators (other than brushes); Hand tools (hand operated) for use by painters (other than brushes); Knives; Knives made of plastic materials; Manually operated apparatus for glue (other than for office use); Manually operated glue dispensers, other than for office use; Apparatus for removing paints (hand operated); Paint shields (hand tool); Painters' knives; Painters' tools (hand operated); Tips for tool bits (parts of hand-operated tools.

Class 16. Brushes for painters; Brushes for the application of paints; Hand held instruments for painting; Hand rollers for applying paint; Hand-rests for painters; House painters' brushes; House painters' roller brushes; House painters' rollers; Instruments for use in painting; Pads for applying paint; Paint applicator pads; Paint applicators; Paint applicators comprising a container and brush; Paint brushes; Paint kettles; Paint pads (applicators); Paint roller

trays; Paint rollers for applying paint; Paint scuttles; Paint trays; Paintbrushes; Painters' brushes; Painting apparatus; Painting instruments; Painting materials for use in the application of paint; Rollers for applying paint; Rollers for use by painters; Stipple applicators for use by painters; Trays for painting; Hand-operated patterning apparatus for applying decorative patterns to walls; Hand-operated patterning apparatus for use by decorators; covers for roller brushes; roller brush frames; extension poles for paint brushes and roller brushes; roller covers; painting accessories; Paintbrushes, including roller brushes; painters drop cloth; all of the aforementioned goods relating to home and/or building decoration; not including artists' brushes.

Australian Brushware Corporation Pty Ltd, Level 2, 20 Council Street, Hawthorn East 3123, Australia.
Address for service is c/o Hardware Lane
Distribution, 500 Avebury Boulevard, MILTON
KEYNES MK92BE, United Kingdom.

DOÑA PAULA ASTOR

262433 13 December 2019

Class 33. Wines and sparkling wines

Viña Doña Paula S.A., Avenida Colón 531, piso 2, Mendoza, Argentina. Address for service is c/o Arthur Cox, 10 Earlsfort Terrace, Dublin 2, DO2 T380, Ireland.

DOÑA PAULA PIEDMONT BLOCKS

262434 13 December 2019

Class 33. Wines and sparkling wines

Viña Doña Paula S.A., Avenida Colón 531, piso 2, Mendoza, Argentina. Address for service is c/o Arthur Cox, 10 Earlsfort Terrace, Dublin 2, DO2 T380, Ireland.

MAKE YOKES A FIVER AGAIN

262435 17 December 2019

Class 25. Clothing; Hats; Shoes.

Sean Loewen, 2A Seagrove, Ballyloughane Road, Renmore, Galway H91 FN4A, Ireland. Address for service is c/o Sean Loewen, 2A Seagrove, Ballyloughane Road, Renmore, Galway H91 FN4A, Ireland.

MPAT

262436 17 December 2019

Class 9. Software; Predictive software; Risk detection software; Downloadable computer software for remote monitoring and analysis; Health monitoring software; Healthcare software; Insurance software.

Class 36. Medical insurance; Health insurance; Accident insurance; Medical insurance underwriting; Health insurance underwriting; Accident insurance underwriting; Evaluation for insurance purposes; Providing information in insurance matters; Information services relating to insurance; Medical insurance services provided to companies; Advisory services relating to life insurance; Advisory services relating to insurance claims; Advice relating to insurance.

Class 44. Healthcare services; Physical rehabilitation.

Medfit Wellness Limited, Blackrock Business Park, Blackrock, Dublin, Ireland. Address for service is c/o Michael Lucey, PurdyLucey IP, 6-7 Harcourt Terrace, Dublin 2, Ireland.

The Bathroom Studio by Topline

262437 17 December 2018

Class 11. Apparatus for lighting, heating, steam generating,

- cooking, refrigerating, drying, ventilating, water supply and sanitary purposes; sanitary apparatus and installations; water supply apparatus; sanitary ware; baths; bath installations; showers and shower installations; shower heads; shower trays; shower doors; shower pans; shower and bath cubicles; basins; bidets; lavatories; toilets; toilet bowls; cabinets for showers; toilet seats; taps (faucets); bath spouts; sinks and sink units; sink pedestals; wash basin stoppers; shower stalls and partitions; water filters; bath screens and shower screens; bath cubicles; water control valves for water cisterns; water control valves; water control valves for faucets; urinals; water cisterns; water softeners; drinking fountains; saunas; radiators; heaters; parts and fittings for all the aforesaid goods.
- Class 20. Furniture, mirrors, picture frames; containers, not of metal, for storage or transport; beds, bedding, mattresses, pillows and cushions; bed frames; bed rails; bed mattresses; bedside tables; bedside lockers; bedside cabinets; chests; chests of drawers; desks; display stands; dressing tables; wardrobes; filing cabinets; bookshelves; wine racks; chairs; chaises longues; tables; kitchen furniture; cupboards; cabinets; door stops of plastic; door stops of wood; door stops, not of metal or rubber; wooden blinds; paper blinds; indoor blinds; window shades [blinds]; slatted indoor blinds; metal indoor window blinds; hangers for clothes; bookcases; deck chairs; hat stands; storage racks; Storage units [furniture]; storage
- boxes [furniture]; storage bins, not of metal; boxes for storage purposes [wood]; boxes for storage purposes [plastic]; bathroom furniture; parts, fittings and accessories for all of the aforesaid goods.
- Class 35. Advertising; business management; business administration; office functions; marketing and promotional services; retail and wholesale services connected with the sale of apparatus for lighting, heating, steam generating, cooking, refrigerating, drying, ventilating, water supply and sanitary purposes; retail and wholesale services relating to sanitary apparatus and installations; retail and wholesale services relating to water supply apparatus; retail and wholesale services relating to sanitary ware, baths, bath installations, showers and shower installations; retail and wholesale services relating to shower heads, shower trays, shower doors, shower pans, shower and bath cubicles, basins, bidets; retail and wholesale services relating to lavatories, toilets, toilet bowls, cabinets for showers, toilet seats, taps (faucets), bath spouts, sinks and sink units, sink pedestals; retail and wholesale services relating to wash basin stoppers, shower stalls and partitions, water filters, bath screens and shower screens, bath cubicles; retail and wholesale services relating to water control valves for water cisterns, water control valves, water control valves for faucets, urinals, water cisterns, water softeners, bath spouts, drinking fountains, saunas, radiators and heaters; retail and wholesale services relating to furniture, mirrors,

picture frames, containers for storage or transport; retail and wholesale services relating to beds, bedding, mattresses, pillows and cushions; retail and wholesale services relating to bed frames, bed rails, bed mattresses, bedside tables, bedside lockers, bedside cabinets, chests, chests of drawers; retail and wholesale services relating to desks, display stands, dressing tables, wardrobes, filing cabinets, bookshelves, wine racks, chairs, chaises longues, tables, kitchen furniture; retail and wholesale services relating to cupboards, cabinets, door stops; retail and wholesale services relating to wooden blinds, paper blinds, indoor blinds, window shades [blinds], slatted indoor blinds, metal indoor window blinds, hangers for clothes, bookcases, deck chairs, hat stands retail and wholesale services relating to storage racks, storage units [furniture], storage boxes [furniture], storage bins, boxes for storage purposes; retail and wholesale services relating to bathroom furniture.

Amalgamated Hardware PLC, Naas Industrial Estate, Naas, Co Kildare, Ireland. Address for service is c/o FRKelly, 27 Clyde Road, Ballsbridge, Dublin 4, Ireland.



262438 16 December 2019

Class 3. Skincare cosmetics.

IOS Skincare Ltd, Killoneen, Daingean, Co. Offaly R35 KH60, Ireland. Address for service is c/o IOS Skincare Ltd, Killoneen, Daingean, Co. Offaly R35 KH60, Ireland.

The mark in use is/will be in the colours silver and gold



262439 12 December 2019

Class 3. Nail varnishes; Nail gel.

Class 6. Nails.

Class 8. Nail buffers.

Nail Fashion Limited c/o Walkinstown Accounting and Taxation Services, Unit G2, Ballymount Drive, Ballymount Rd Lower, Dublin, Ireland. Address for service is c/o Nail Fashion Limited c/o Walkinstown Accounting and Taxation Services, Unit G2, Ballymount Drive, Ballymount Rd Lower, Dublin, Ireland.

The mark in use is/will be in the colour(s) Black

ELECTROSAL

262440 12 December 2019

Class 5. Pharmaceuticals, medical and veterinary preparations; Medicine; Sanitary preparations for medical purposes; Dietetic food and substances adapted for medical or veterinary use, food for babies; Dietary supplements for human beings and animals; Plasters, materials for dressings; Material for stopping teeth, dental wax; Disinfectants; Preparations for destroying vermin; Fungicides, herbicides.

STADA Arzneimittel AG, Stadastraße 2 - 18, 61118 Bad Vilbel, Germany. Address for service is c/o TOMKINS & CO., 5 Dartmouth Road, Dublin 6, Ireland.

EIRP

262441 17 December 2019

Class 9. Software; Predictive software; Risk detection software; Downloadable computer software for remote monitoring and analysis; Health monitoring software; Healthcare software; Insurance software.

Class 36. Medical insurance; Health insurance; Accident insurance; Medical insurance underwriting; Health insurance underwriting;

Accident insurance underwriting; Evaluation for insurance purposes; Providing information in insurance matters; Information services relating to insurance; Medical insurance services provided to companies; Advisory services relating to life insurance; Advisory services relating to insurance claims; Advice relating to insurance.

Class 44. Healthcare services; Physical rehabilitation.

Medfit Wellness Limited, Blackrock Business Park, Blackrock, Dublin, Ireland. Address for service is c/o Michael Lucey, PurdyLucey IP, 6-7 Harcourt Terrace, Dublin 2, Ireland.



262442 16 December 2019

Class 35. Business investigation; Investigations (Business -); Business investigations; Business enquiries and investigations; Business information and research services; Research services relating to business.

Class 36. Insurance investigations; Financial investigation services; Financial solvency investigations.

Class 45. Private investigation; Accident investigation; Detective investigations; Legal investigation services; Private investigation services; Missing persons investigation; Investigations (Personal

background -); Investigations (Missing person -); Missing person investigations; Personal background investigations; Background investigation and research services; Pre-employment background investigation services; Investigation services related to insurance claims; Consultancy services relating to private investigations; Investigations in relation to intellectual property; Provision of legal research.

Priority Investigations Ireland Limited, Suite 10072, 26 Upper Pembroke Street, Dublin D02 X361, Ireland. Address for service is c/o Priority Investigations Ireland Limited, Suite 10072, 26 Upper Pembroke Street, Dublin D02 X361, Ireland.

The mark in use is/will be in the colours blue and grey



262443 13 December 2019

Class 43. Cafés; Wine bars.

Nicola Abbott, Cloosh Lodge, Doorus, Kinvara H91XVW9, Ireland. Address for service is c/o Nicola Abbott, Cloosh Lodge, Doorus, Kinvara H91XVW9, Ireland.

The mark in use is/will be in the colour(s) Pantone 440, Pantone 583 and Pantone 7508

AIRLINK

262444 03 December 2019

- Class 9. Application software; downloadable software; electronic publications.
- Class 16. Printed matter; instructional and teaching materials; stationery; diaries; pens and pencils; credit card holders; office requisities; office requisities; bookmarkers; calendars; magazines; beer mats; posters; printed timetables; tickets and signboards of paper or cardboard; all being included in Class 16.
- Class 39. Transport services; passenger transport; transport and delivery of goods; courier services; travel agency and booking services; provision of information relating to transport; tourist information services.

BUS ÁTHA CLIATH / DUBLIN BUS, 59 Upper O'Connell Street, Dublin 1, Ireland. Address for service is c/o FRKelly, 27 Clyde Road, Ballsbridge, Dublin 4, Ireland.

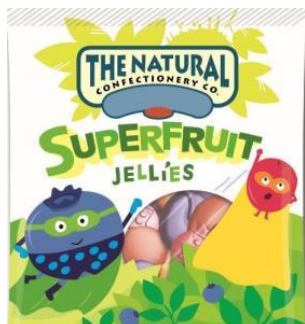

262445 18 December 2019

Class 30. Cocoa; cocoa and chocolate based beverages and preparations for making such beverages; chocolate, confectionery, in particular chocolate confectionery and sugar confectionery; biscuits, wafers, cakes, pastries, cheesecakes, baked and dough products; preparations made from cereals; edible ices, namely ice cream products, frozen confectionery and desserts; chilled confectionery and desserts; chocolate spreads.

Mondelez International AMEA Pte. Ltd., 346 Jalan Boon Lay, Jurong, Singapore 619528, Singapore. Address for service is c/o MACLACHLAN & DONALDSON, Unit 10, 4075 Kingswood Road, Citywest Business Campus, Dublin 24 D24 C56E, Ireland.



262446 18 December 2019

Class 9. Electric alarms for fire; Alarms (Fire -); Fire alarms;

Closed circuit television systems; Closed circuit television systems (CCTV); Closed circuit television apparatus; Closed circuit television cameras; Closed circuit TV [CCTV] software; Burglar alarms; Electronic burglar alarms; Electrical and electronic burglar alarms.

Class 37. Fire alarms (Installation of -); Providing information relating to the repair or maintenance of fire alarms; Repair or maintenance of fire alarms; Fire alarms (Repair of -); Fire alarm repair; Fire alarm installation and repair; Maintenance and repair of fire alarm systems; Maintenance and servicing of fire alarm systems; Installation of closed circuit television systems; Installation of burglar alarms; Installation, maintenance and repair of burglar alarms.

Class 45. Providing information relating to the rental of fire alarms; Fire alarms (Rental of -); Rental of fire alarms; Leasing of fire alarms; Monitoring of fire alarms; Monitoring fire alarms; Closed-circuit surveillance; Monitoring burglar and security alarms; Monitoring of burglar and security alarms.

Scan Alarms & Security Systems (UK) Limited, 52 Trench Road, Mallusk, Newtownabbey BT36 4TY, United Kingdom. Address for service is c/o Hayes Solicitors, Lavery House, 2 Earlsfort Terrace, Dublin Dublin 2, Ireland.

The mark in use is/will be in the colour(s) Red, Black and White



262447 18 December 2019

- Class 9. Electric alarms for fire; Alarms (Fire -); Fire alarms; Closed circuit television systems; Closed circuit television systems (CCTV); Closed circuit television apparatus; Closed circuit television cameras; Closed circuit TV [CCTV] software; Burglar alarms; Electronic burglar alarms; Electrical and electronic burglar alarms.
- Class 37. Fire alarms (Installation of -); Providing information relating to the repair or maintenance of fire alarms; Repair or maintenance of fire alarms; Fire alarms (Repair of -); Fire alarm repair; Fire alarm installation and repair; Maintenance and repair of fire alarm systems; Maintenance and servicing of fire alarm systems; Installation of closed circuit television systems; Installation of burglar alarms; Installation, maintenance and repair of burglar alarms.
- Class 45. Providing information relating to the rental of fire alarms; Fire alarms (Rental of -); Rental of fire alarms; Leasing of fire alarms; Monitoring of fire alarms; Monitoring fire alarms; Closed-circuit surveillance; Monitoring burglar and security alarms; Monitoring of burglar and security alarms.

Scan Alarms & Security Systems (UK) Limited, 52 Trench Road, Mallusk, Newtownabbey BT36 4TY, United Kingdom. Address for service is c/o Hayes Solicitors, Lavery House, 2 Earlsfort Terrace, Dublin Dublin 2, Ireland.

The mark in use is/will be in the colour(s) Red, Black and White

SILLY COW

SILLY COW!

Application is for a Series of 2 Trade Marks.

262448 18 December 2019

- Class 6. Keyrings, key chains; badges; ornaments; figurines; signs; all made of common metals and their alloys.
- Class 9. Magnets, magnetic ornaments and figurines; mouse mats and mouse pads; mobile phone cases.
- Class 14. Jewellery, watches; lapel pins, enamel pins, key fobs, phone charms; clocks.
- Class 16. Pens, pencils; pencil cases; tops for pencils; notebooks; bookmarkers; stationery; pencil sharpeners, erasers, rulers, notebook and pen sets.
- Class 18. Bands of leather and imitation leather; leather and imitation leather; key cases made of leather; key cases made of imitation leather; leather cases; imitation leather cases; rucksacks; backpacks; shoulder bags; school bags; bags, shopping bags, shoulder bags, coin purses, handbags, cases, wallets, purses, keyholders, luggage; umbrellas and parasols; parts

- and fittings for all the aforesaid goods.
- Class 21. Glassware, beverageware; cups; mugs; shot glasses, tankards, coasters, trays; beakers (other than laboratory beakers); barware, namely, cork screws, cork holders, bottle openers, beverage stirrers; containers for foods; containers for household or kitchen use; hair brushes and combs; candle holders, candle rings and candlesticks not of precious metal; glass boxes; non-metal decorative boxes; vases; figurines made of china, crystal, earthenware, glass, porcelain and terra cotta; non-metal piggy banks; souvenir and decorative plates; oven gloves; pot holders, bottle openers; bottle openers incorporated into pens, pencils or magnets; money boxes; tea cosies; lunch boxes; tea bag holders; mug and spoon sets; drinking beakers; tumblers; smoothie cups; spoon rests; travel mugs; insulated mugs; vacuum mugs.
- Class 24. Textile articles for household use; textile towels; tea towels; kitchen towels, beach towels.
- Class 25. Clothing, footwear, headgear, cooking aprons, eye masks.
- Class 26. Badges for wear, not of precious metal; hair bands; hair pins; hair ribbons; bows for the hair; brooches (clothing accessories); buckles (clothing accessories); buttons; sewing boxes; heat adhesive patches for decoration of textile articles; hair ornaments; lanyards (cords) for wear; belt buckles; hair clips.
- Class 28. Games and playthings; dolls, toys; balls for games; rugby balls; balls for juggling; non-metallic soft balls; balls for play; balloons; three-dimensional puzzles; snow globes; waterballs; Christmas

- tree decorations (other than edible or for illumination); playing cards; beach balls.
- Class 30. Confectionery; chocolates.

The Shamrock Gift Company (Trading House) Unlimited Company, Unit 16, Trinity Court, Fonthill Industrial Park, Fonthill Road, Dublin 22, Ireland. Address for service is c/o FRKelly, 27 Clyde Road, Ballsbridge, Dublin 4, Ireland.



Application is for a Series of 2 Trade Marks.

262449 18 December 2019

- Class 6. Keyrings, key chains; badges; ornaments; figurines; signs;

- all made of common metals and their alloys.
- Class 9. Magnets, magnetic ornaments and figurines; mouse mats and mouse pads; mobile phone cases.
- Class 14. Jewellery, watches; lapel pins, enamel pins, key fobs, phone charms; clocks.
- Class 16. Pens, pencils; pencil cases; tops for pencils; notebooks; bookmarkers; stationery; pencil sharpeners, erasers, rulers, notebook and pen sets.
- Class 18. Bands of leather and imitation leather; leather and imitation leather; key cases made of leather; key cases made of imitation leather; leather cases; imitation leather cases; rucksacks; backpacks; shoulder bags; school bags; bags, shopping bags, shoulder bags, coin purses, handbags, cases, wallets, purses, keyholders, luggage; umbrellas and parasols; parts and fittings for all the aforesaid goods.
- Class 21. Glassware, beverageware; cups; mugs; shot glasses, tankards, coasters, trays; beakers (other than laboratory beakers); barware, namely, cork screws, cork holders, bottle openers, beverage stirrers; containers for foods; containers for household or kitchen use; hair brushes and combs; candle holders, candle rings and candlesticks not of precious metal; glass boxes; non-metal decorative boxes; vases; figurines made of china, crystal, earthenware, glass, porcelain and terra cotta; non-metal piggy banks; souvenir and decorative plates; oven gloves; pot holders, bottle openers; bottle openers incorporated into pens, pencils or magnets; money boxes; tea cosies; lunch boxes; tea bag holders; mug and spoon sets; drinking beakers; tumblers; smoothie cups; spoon rests; travel mugs; insulated mugs; vacuum mugs.
- Class 24. Textile articles for household use; textile towels; tea towels; kitchen towels, beach towels.
- Class 25. Clothing, footwear, headgear, cooking aprons, eye masks.
- Class 26. Badges for wear, not of precious metal; hair bands; hair pins; hair ribbons; bows for the hair; brooches (clothing accessories); buckles (clothing accessories); buttons; sewing boxes; heat adhesive patches for decoration of textile articles; hair ornaments; lanyards (cords) for wear; belt buckles; hair clips.
- Class 28. Games and playthings; dolls, toys; balls for games; rugby balls; balls for juggling; non-metallic soft balls; balls for play; balloons; three-dimensional puzzles; snow globes; waterballs; Christmas tree decorations (other than edible or for illumination); playing cards; beach balls.
- Class 30. Confectionery; chocolates.

The Shamrock Gift Company (Trading House)
 Unlimited Company, Unit 16, Trinity Court, Fonthill
 Industrial Park, Fonthill Road, Dublin 22, Ireland.
 Address for service is c/o FRKelly, 27 Clyde Road,
 Ballsbridge, Dublin 4, Ireland.



262450 18 December 2019

Class 6. Keyrings, key chains; badges; ornaments; figurines; signs; all made of common metals and their alloys.

Class 9. Magnets, magnetic ornaments and figurines; mouse mats and mouse pads; mobile phone cases.

Class 14. Jewellery, watches; lapel pins, enamel pins, key fobs, phone charms; clocks.

Class 16. Pens, pencils; pencil cases; tops for pencils; notebooks; bookmarkers; stationery; pencil sharpeners, erasers, rulers, notebook and pen sets.

Class 18. Bands of leather and imitation leather; leather and imitation leather; key cases made of leather; key cases made of imitation leather; leather cases; imitation leather cases; rucksacks; backpacks; shoulder bags; school bags; bags, shopping bags, shoulder bags, coin purses, handbags, cases, wallets, purses, keyholders, luggage; umbrellas and parasols; parts and fittings for all the aforesaid goods.

Class 21. Glassware, beverage ware; cups; mugs; shot glasses, tankards, coasters, trays; beakers (other than laboratory beakers); barware, namely, cork screws, cork holders,

bottle openers, beverage stirrers; containers for foods; containers for household or kitchen use; hair brushes and combs; candle holders, candle rings and candlesticks not of precious metal; glass boxes; non-metal decorative boxes; vases; figurines made of china, crystal, earthenware, glass, porcelain and terra cotta; non-metal piggy banks; souvenir and decorative plates; oven gloves; pot holders, bottle openers; bottle openers incorporated into pens, pencils or magnets; money boxes; tea cosies; lunch boxes; tea bag holders; mug and spoon sets; drinking beakers; tumblers; smoothie cups; spoon rests; travel mugs; insulated mugs; vacuum mugs.

Class 24. Textile articles for household use; textile towels; tea towels; kitchen towels, beach towels.

Class 25. Clothing, footwear, headgear, cooking aprons, eye masks.

Class 26. Badges for wear, not of precious metal; hair bands; hair pins; hair ribbons; bows for the hair; brooches (clothing accessories); buckles (clothing accessories); buttons; sewing boxes; heat adhesive patches for decoration of textile articles; hair ornaments; lanyards (cords) for wear; belt buckles; hair clips.

Class 28. Games and playthings; dolls, toys; balls for games; rugby balls; balls for juggling; non-metallic soft balls; balls for play; balloons; three-dimensional puzzles; snow globes; waterballs; Christmas tree decorations (other than edible or for illumination); playing cards; beach balls.

Class 30. Confectionery; chocolates.

The Shamrock Gift Company (Trading House) Unlimited Company, Unit 16, Trinity Court, Fonthill Industrial Park, Fonthill Road, Dublin 22, Ireland. Address for service is c/o FRKelly, 27 Clyde Road, Ballsbridge, Dublin 4, Ireland.

MINERAL BOOST

262451 19 December 2019

- Class 3. Non-medicated toilet preparations, dentifrices, mouthwashes and breath fresheners; oral care preparations, dental gels, bleaching preparations, tooth polishing preparations, tooth whitening preparations and accelerators, cosmetic stain removal preparations.
- Class 5. Medicated oral care preparations, medicated tooth polishing preparations, medicated tooth whitening preparations, medicated mouthwashes, medicated bleaching preparations, medicated chewing gum and lozenges for dental hygiene.
- Class 21. Toothbrushes, toothpicks, dental floss, brushes and sponges.

Stafford-Miller (Ireland) Limited, Clocherane, Youghal Road, Dungarvan, Co. Waterford, Ireland. Address for service is c/o Tomkins & Co, 5 Dartmouth Road, Dublin 6, Ireland.

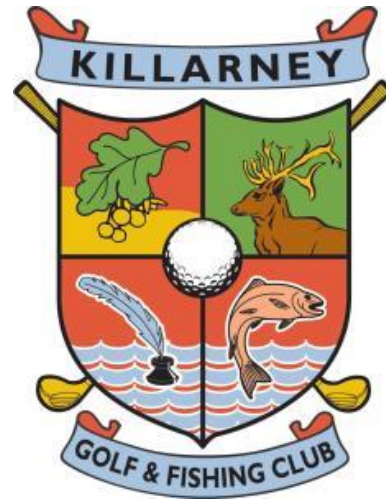

262452 18 December 2019

Class 41. Golf courses.

Killarney Golf & Fishing Club, Mahony's Point, Killarney, Kerry, Ireland. Address for service is c/o Killarney Golf & Fishing Club, Mahony's Point, Killarney, Kerry, Ireland.

The mark in use is/will be in the colour(s)
Navy#272a3fGold#cd9300Light Navy #434869

Charles Fort Irish Whiskey

262453 20 November 2019

Class 33. Whiskey complying with the specifications of the protected geographical indication 'Irish Whiskey'.

Tomahawk Liberty Limited, Compass Hill, Kinsale, Co Cork P17 X365, Ireland. Address for service is c/o Tomahawk Liberty Limited, c/o Colin Ross, Unit E5, Grange Ind Est, Ballycurreen T12 XP2N, Ireland.

Clew Bay

262454 03 December 2019

Class 31. Food (Pet -); Pet food; Pet foods; Pet foodstuffs; Pet food for dogs; Foodstuffs for pet animals.

Amazon Investments Ltd. trading as Irish Pet Foods, Roman Island, The Quay, Westport, Co. Mayo F28 KW65, Ireland. Address for service is c/o Amazon Investments Ltd. trading as Irish Pet Foods, Roman Island, The Quay, Westport, Co. Mayo F28 KW65, Ireland.



262455 02 December 2016

Class 1. Chemicals used in industry, chemicals for refrigeration and freezer systems, especially refrigerators; stearic acid; gases and gas products for industrial use; gas and gas products for agricultural purposes (except fungicides and preparations for destroying weeds and pests); gases not intended for combustion purposes, not for illumination, not for medical purposes, such as nebulizing gases for aerosols, for adding CO₂ to beverages and LPG for refrigeration and air conditioning.

Class 4. Industrial oils and greases, lubricants, dust absorbing, wetting and binding compositions, fuels (including fuels for motors) and illuminants, gas for lighting, generator gases, candles and wicks for lighting; paraffin, petrolatum, gases and gas products for combustion purposes, liquefied gas.

Class 6. Metal LPG cylinders and containers of LPG tanks (no parts of vehicles); metal parts, namely locking mechanisms, faucets, valves and connectors destined for use in relation to the LPG cylinders and containers and LPG tanks.

Class 35. Advertising, business management, business administration, administrative services, preparation of statistics, trade information, marketing, market research and analysis, business consultancy to enterprises in the area of gas exploitation, transport, packaging, sales and environmental requirements; business services related to sustainable and clean energy, electricity, gas and heat; business management related to observation of commercial interests of third parties.

Class 42. Scientific and technological services as well as research and design services relating thereto; services in the field of industrial analysis and research; consultancy in the field of biotechnology; scientific and technological consultancy in the areas of gas extraction, transport, packaging and environmental requirements; scientific and technological consultancy in the field of renewable energy, electricity, gas, heat, biomass industry, generation of biomass energy and biomass conversion; scientific and industrial research into the

generation and use of renewable energy and to other possibilities for alternative energy sources.

Calor Teoranta, Long Mile Road, Dublin 12, Ireland.
Address for service is c/o DWF, 5 George's Dock, IFSC, Dublin 1, Ireland.

The application for registration is proceeding with the consent of the proprietors of registered Irish Trade Mark Numbers 90381, 81755, 79461, 99005, 110249, 110250, 220838, 219938, 229737, 237281, and 248685 and European Union Trade Mark Number 001758549, 013129391 and 015428196

The mark in use is/will be in the colour(s) Red and Black



262456 22 February 2017

Class 1. Chemicals used in industry, chemicals for refrigeration and freezer systems, especially refrigerators; stearic acid; gases and gas products for industrial use; gas and gas products for agricultural purposes (except fungicides and preparations for destroying weeds and pests); gases not intended for combustion purposes, not for

illumination, not for medical purposes, such as nebulizing gases for aerosols, for adding CO₂ to beverages and LPG for refrigeration and air conditioning.

Class 4. Industrial oils and greases, lubricants, dust absorbing, wetting and binding compositions, fuels (including fuels for motors) and illuminants, gas for lighting, generator gases, candles and wicks for lighting; paraffin, petrolatum, gases and gas products for combustion purposes, liquefied gas.

Class 6. Metal LPG cylinders and containers of LPG tanks (no parts of vehicles); metal parts, namely locking mechanisms, faucets, valves and connectors destined for use in relation to the LPG cylinders and containers and LPG tanks.

Class 35. Advertising, business management, business administration, administrative services, preparation of statistics, trade information, marketing, market research and analysis, business consultancy to enterprises in the area of gas exploitation, transport, packaging, sales and environmental requirements; business services related to sustainable and clean energy, electricity, gas and heat; business management related to observation of commercial interests of third parties.

Class 42. Scientific and technological services as well as research and design services relating thereto; services in the field of industrial analysis and research; consultancy in the field of biotechnology; scientific and technological consultancy in the areas of gas extraction, transport, packaging and environmental requirements; scientific and technological consultancy in

the field of renewable energy, electricity, gas, heat, biomass industry, generation of biomass energy and biomass conversion; scientific and industrial research into the generation and use of renewable energy and to other possibilities for alternative energy sources.

Calor Teoranta, Long Mile Road, Dublin 12, Ireland.
Address for service is c/o DWF, 5 George's Dock, IFSC, Dublin 1, Ireland.

The application for registration is proceeding with the consent of the proprietors of registered Irish Trade Mark Numbers 79460, 79498, 41510, 90381, 81755, 79461, 99005, 110249, 110250, 220838, 219938, 229737, 237281, 248685, 250021 and European Union Trade Mark Numbers 001758549, 015428196, 013129391 and 010205052.

The mark in use is/will be in the colour(s) Red and Black

CADBURYNESS

262457 20 March 2019

Class 29. Dairy products; dairy-based food products; milk and milk products; milk-based beverages including flavoured milk drinks; milk shakes; beverages predominantly made from milk substitutes; yoghurt and yoghurt-based beverages; fromage frais; fruit desserts; dairy desserts; fruit desserts; yoghurt desserts; chilled dairy desserts, artificial milk based desserts; desserts made from milk products; preparations for making dairy desserts, yoghurt desserts, chilled dairy

desserts, artificial milk based desserts and desserts made from milk products; fruit toppings; cheese spreads; hazelnut spreads; dairy spreads; vegetable spreads; fruit spreads; potato-based snack foods; fruit based snack foods; vegetable based snack foods; cheese-based snack foods.

Class 30. Cocoa; cocoa products; drinking chocolate; chocolate and cocoa drinking powders; preparations for making chocolate or cocoa based drinks; beverages made from or containing chocolate; beverages made from or containing cocoa; malt chocolate; malt chocolate extracts; malt based food preparations; mixtures of chocolate and malt; roasted barley and malt used as a substitute for chocolate; chocolate; chocolates, confectionery; preparations for making cereals; cereal-based snack foods; cereal bars; muesli bars; biscuits; wafers; cakes; pastries; muffins; cake-mixes; muffin-mixes; mousse; chocolate spreads; ice cream and ice cream products; chilled and frozen confections; frozen confectionery; frozen yoghurts; chocolate desserts; ice cream desserts; prepared desserts (confectionery); chilled desserts namely chocolate desserts, ice cream desserts and prepared desserts (confectionery); confectionery toppings; biscuit toppings; chocolate toppings; toppings made from confectionery; sugar and candy toppings.

CADBURY UK LIMITED, P.O. Box 12, Bournville Lane, Bournville, Birmingham B30 2LU, United Kingdom. Address for service is c/o MACLACHLAN & DONALDSON, Unit 10, 4075 Kingswood Road, Citywest Business Campus, Dublin 24 D24 C56E, Ireland.

Stephen King, 9 Tramway Tce, Douglas, Cork T12YP23, Ireland. Address for service is c/o Stephen King, 9 Tramway Tce, Douglas, Cork T12YP23, Ireland.

Griff Consulting

262458 19 December 2019

- Class 35. Accounting services; Administrative accounting; Accounting advisory services; Book-keeping and accounting; Consulting and information concerning accounting; Provision of initial company secretarial services on company formation.
- Class 45. Legal services relating to company formation and registration.

Ildiko Fodor, 1 Hova Villas, Hove, East Sussex BN3 3DH, United Kingdom. Address for service is c/o Ildiko Fodor, 1 Hova Villas, Hove, East Sussex BN3 3DH, United Kingdom.

1601 Single Malt Whiskey

262459 20 December 2019

- Class 33. Whiskey.

Brytestar

262460 19 December 2019

- Class 9. Labels carrying electronically recorded or encoded information; Labels carrying magnetically recorded or encoded information; Labels carrying optically recorded or encoded information; Recording disks; Recording discs; Recording apparatus; Video recordings; Musical recordings; Music recordings; Magnetic recordings; Audiovisual recordings; Digital recordings; Sound recordings; Audio recordings; Strips (Sound recording -); Optical recording media; Recording substrates [optical]; Recording substrates [magnetic]; DVD recording apparatus; Audio recording apparatus; Sound recording carriers; Video streaming devices; Broadcasting satellites; Music software; Music headphones; Downloadable music files; Educational software; Recorded films; Downloadable media; Digital recording media; Electronic storage media; Downloadable educational media; Media server software; Studio monitor loudspeakers; Master audio mixing desks for use in recording studios; Vinyl records; Record decks;

- Records [sound recordings]; Phonographic records; Sound records; LP records; Disc records; Gramophone records; Phonograph records; Pre-recorded phonograph records; Recorded film; Record players; Cartoons (Animated -); Video tapes with recorded animated cartoons; Video disks with recorded animated cartoons; Animated cartoons in the form of cinematographic films; 3D animation software; Animation software; Podcasts; Downloadable podcasts; Motion pictures; Recorded media; Media content; Multi-media recordings; Photographic media [films, exposed].
- Class 38. Music broadcasting; Streaming of audio material on the internet; Streaming of video material on the internet; Streaming audio and video material on the Internet; Streaming of audio, visual and audiovisual material via a global computer network; Audio broadcasting; Television broadcasting; Radio broadcasting; Wireless broadcasting; Satellite television broadcasting; Television programme broadcasting; Television broadcasting services; Video broadcasting; Satellite broadcasting; Broadcasting (Television -); Broadcasting; Internet broadcasting services; Radio programme broadcasting; Radio broadcasting services; Radio program broadcasting; Digital audio broadcasting; Subscription television broadcasting; Television and radio broadcasting; Cable television broadcasting; Data broadcasting services; Podcasting; Podcasting services; Transmission of podcasts.
- Class 41. Music recording; Music concerts; Music publishing; Music production; Music-halls; Theatre entertainment; Theatre production; Theatre performances; Theatre productions; Theatre production services; Movie theatre presentations; Direction of theatre shows; Organising of theatre productions; Artistic management of theatres; Artistic management of theatre shows; Entertainment by means of theatre productions; Recording studios; Recording services; Sound recording services; Audio recording services; Recording of music; Studio services (Recording -); Sound recording studios; Video recording services; Recording studio services; Record masters (Production of -); Production of record masters; Music performances; Music instruction; Music production services; Music publishing services; Publishing of music; Music-hall services; Tuition in music; Performance of music; Instruction in music; Music performance services; Music entertainment services; Music library services; Music concert services; Production of music; Music mixing services; Production of films; Production of videos; Production of cabarets; Production of animation; Shows (Production of -); Production of plays; Production of documentaries; Production of shows; Production of stage shows; Production of operas; Production of stage performances; Production of cinema films; Production of cine-films; Production of motion pictures; Radio programmes (Production of -); Production of radio

broadcasts; Production of radio programmes; Production of radio programs; Production of video films; Production of television programs; Production of TV shows; Production of television programmes; Production of television features; Production of audiovisual recordings; Production of musical recordings; Production of sporting events; Production of talent shows; Production of teaching reports; Production of video-tapes; Production of live performances; Production of live shows; Production of video recordings; Production of television films; Production of audio entertainment; Production of sound recordings; Production of audio recordings; Production of stage plays; Production of live entertainment; Production of theatrical shows; Production of theatrical performances; Production of training videos; Production of training films; Production of film studies; Production of musical videos; Production of music shows; Production of audio programs; Production of music concerts; Production of esports events; Directing of theater productions; Production of motion picture films; Production of audio-visual recordings; Production of television entertainment features; Production of television entertainment programmes; Cable television programmes (Production of -); Production of audio/visual presentations; Production of live television programmes; Production of live entertainment features; Production of movie special effects; Production of educational television programmes; Production of live entertainment events;

Production of animated motion pictures; Production of films in studios; Production of audio master recordings; Staging of light entertainment productions; Production of films for educational purposes; Television programmes (Production of radio and -); Radio and television programmes (Production of -); Production of radio and television programs; Production of television or radio programmes; Production of radio or television programs; Production of television and radio programs; Production of television and radio programming; Production of special effects for radio; Production of sound and music recordings; Production of video and audio recordings; Production of sound and video recordings; Production of radio and television programmes; Production of educational sound and video recordings; Production of audio tapes for entertainment purposes; Production of radio and of television programmes; Fan club services; Fan club services (entertainment); Fan club organisation; Fan clubs; Theatre services; Rental of theatre scenery; Radio production services; Radio entertainment production; Education; Education services; Further education; Educational seminars; Management education services; Musical education services; Artistic management of performing artists; Artistic direction of performing artists; Modelling services for artists; Artistic management of music venues; Artistic management of entertainment venues; Entertainment services provided by performing artists; Gallery

services (Art -); Art gallery services; Art gallery services provided on-line via a telecommunications link; Rehearsal [recording] studio services; Film production; Film editing; Film rental; Film hire; Film studios; Film distribution; Production (Videotape film -); Videotape film production; Film editing (Photographic -); Film production services; Film studio services; Video film production; Film and video tape film production; Movie studios; Dance studios; Cinema studios; Cinema studio services; Television studio services; Movie studio services; Motion picture studios; Music recording studio services; Audio recording studio services; Sound recording studio services; Providing dance studio facilities; Motion picture studio services; Cinematographic film studio services; Rental of film studios; Operating of film studios; Rental of recording studios; Hire of recording studios; Provision of recording studio services; Recording studio facilities (Provision of -); Studio facilities (Provision of recording -); Providing audio or video studio services; Providing audio or video studios; Recording studio services for films; Recording studio services for television; Recording studio services for videos; Provision of recording studio facilities; Provision of film studio facilities; Studio services for the recording of cine-films; Production of musical works in a recording studio; Recording studio services for the production of sound bearing discs; Record mastering; Creating animated cartoons; Production of

animated cartoons; Animation production services; Special effects animation services for film and video; Cinema entertainment; Interactive entertainment; Musical entertainment; Entertainment; Live entertainment; Radio entertainment; Entertainment services; Television entertainment; Hospitality services (entertainment); Sports entertainment services; Entertainment by film; Musical entertainment services; Interactive entertainment services; Popular entertainment services; Audio entertainment services; Radio entertainment services; Video entertainment services; Musical group entertainment services; Television and radio entertainment; Provision of musical entertainment; Staged light entertainment services; Arranging of musical entertainment; Booking of entertainment halls; Entertainment provided by telephone; Live entertainment production services; Publishing; Song publishing; Multimedia publishing; Online digital publishing services; Book and review publishing; Multimedia entertainment software publishing services; Music publishing and music recording services; Art exhibitions; Art gallery services; Motion picture production; Motion picture film production; Songwriting; Songwriting services for non-advertising purposes; Photography; Photography services; Entertainment; Preparation of documentary programmes for broadcasting; Preparation of documentary programmes for the cinema; Publishing; Book publishing; Newspaper publishing;

Magazine publishing;
 Publishing services;
 Electronic publishing;
 Publishing of reviews; On-
 line publishing services;
 Publishing of musical works;
 Publishing of web magazines;
 Multimedia publishing of
 books; Multimedia publishing
 of newspapers; Publishing of
 scripts for theatrical use;
 Digital video, audio and
 multimedia entertainment
 publishing services;
 Publishing of interactive
 computer and video game
 software.

Brian Sheil, 6 Woodgrove, Tullow Road, Carlow
 R93F2K8, Ireland. Address for service is c/o Brian
 Sheil, 6 Woodgrove, Tullow Road, Carlow R93F2K8,
 Ireland.

Beal Na Blath Whiskey

262461 20 December 2019

Class 33. Whiskey.

Stephen King, 9 Tramway Tce, Douglas, Cork
 T12YP23, Ireland. Address for service is c/o Stephen
 King, 9 Tramway Tce, Douglas, Cork T12YP23,
 Ireland.

Fort Camden Whiskey

262462 20 December 2019

Class 33. Whiskey.

Stephen King, Tramway Tce, Douglas, Cork
 T12YP23, Ireland. Address for service is c/o Stephen
 King, Tramway Tce, Douglas, Cork T12YP23,
 Ireland.

RCYC 1720 Gin

262463 20 December 2019

Class 33. Gin.

Stephen King, Tramway Tce, Douglas, Cork
 T12YP23, Ireland. Address for service is c/o Stephen
 King, Tramway Tce, Douglas, Cork T12YP23,
 Ireland.

APHRIA

262464 16 November 2018

Class 3. Non-medicated cosmetics and
 toiletry preparations;
 perfumery, essential oils; bath
 additives; bath herbs; bath
 oils; bath oils for cosmetic
 purposes; beauty care
 cosmetics; beauty creams for
 body care; beauty gels; beauty
 lotions; body and beauty care
 cosmetics; body creams; body
 oils; cosmetic creams;
 cosmetic oils; cosmetics and
 make-up; face and body
 lotions; face and body milk;
 face lotion; hair care
 preparations; hair styling
 preparations; hand cream;

Class 5.	<p>hand lotions; lip care preparations; lip conditioners; lip glosses; liquid soaps; massage creams; massage oils; non-medicated bubble bath preparations; non-medicated preparations for the care of hair; non-medicated preparations for the care of skin; non-medicated preparations for the care of the scalp; non-medicated skin care preparations; oils for toiletry purposes; skin care preparations; skin creams; skin emollients; skin lotions; skin soap; soaps for body care; soaps for personal use.</p> <p>Products containing cannabidiol, namely, oils; oils containing cannabidiol; Products containing cannabidiol, namely oils, salves, concentrated pastes, tinctures, tablets and capsules; oils, salves, concentrated pastes, tinctures, tablets and capsules; nutraceuticals for medicinal purposes; nutraceuticals for medicinal purposes containing cannabidiol; nutraceuticals for medicinal purposes, namely resins and oils containing cannabidiol; topical skin creams, bar and liquid soaps, bath additives, bath herbs, bath oils, body creams, body oils, face and body lotions, face and body milk, face lotion, and skin care preparations each containing cannabidiol; each of the aforementioned products for the relief of pain, for relaxation, for reducing stress and fatigue, for mood enhancement, for maintaining general health and well-being, for relieving anxiety, for relieving depression, as a sleep aid; personal sexual lubricants; transdermal patches containing cannabidiol; oral sprays containing cannabidiol;</p>	<p>pharmaceuticals, medical and veterinary preparations; sanitary preparations for medical purposes; dietetic food and substances adapted for medical or veterinary use, food for babies; dietary supplements for humans and animals; plasters, materials for dressings.</p> <p>Class 9. Compact discs, DVDs and other digital recording media; computer software; electronic publications, namely, newsletters, brochures, reports and guides pertaining to cannabidiol.</p> <p>Class 16. Paper and cardboard; printed matter; photographs; stationery and office requisites, except furniture; drawing materials and materials for artists; instructional and teaching materials; printed publications, namely, newsletters, brochures, reports and guides pertaining to cannabidiol.</p> <p>Class 21. Household or kitchen utensils and containers; cookware and tableware, except forks, knives and spoons; combs and sponges; brushes, except paintbrushes; brush-making materials; glassware, porcelain and earthenware; jars.</p> <p>Class 25. Clothing, footwear, headgear; athletic apparel; baseball caps; beachwear; caps; casual wear; coveralls; flip-flops; gloves; golf caps; golf shirts; hats; headbands; long-sleeved t-shirts; mittens; novelty hats; sandals; shirts; sweatshirts; toques; t-shirts.</p> <p>Class 29. Preserved, frozen, dried and cooked fruits and vegetables; jellies, jams, compotes; milk and milk products; oils and fats for food; edible oils and resins made, derived or extracted from cannabis plants containing cannabidiol; food products, namely butter,</p>
----------	---	--

- containing cannabidiol; food products, namely butter, containing resins made, derived or extracted from cannabis plants that contain cannabidiol; food products, namely butter, containing oils made, derived or extracted from cannabis plants that contain cannabidiol.
- Class 30. Coffee, tea, cocoa and artificial coffee; rice; tapioca and sago; flour and preparations made from cereals; bread, pastries and confectionery; edible ices; sugar, honey, treacle; yeast, baking-powder; salt; mustard; vinegar, sauces [condiments]; spices; ice [frozen water]; food products, namely chocolates, cookies, brownies, candy and cereal-based energy bars containing cannabidiol; food products, namely chocolates, cookies, brownies, candy and cereal-based energy bars containing resins made, derived or extracted from cannabis plants containing cannabidiol; food products, namely chocolates, cookies, brownies, candy and cereal-based energy bars containing oils made, derived or extracted from cannabis plants containing cannabidiol; teas, namely teas containing cannabidiol; teas, namely teas containing resins made, derived or extracted from cannabis plants containing cannabidiols; teas, namely teas containing oils made, derived or extracted from cannabis plants containing cannabidiol.
- Class 31. Raw and unprocessed agricultural, aquacultural, horticultural and forestry products; raw and unprocessed grains and seeds; fresh fruits and vegetables, fresh herbs; natural plants and flowers; bulbs, seedlings and seeds for planting; foodstuffs and beverages for animals; malt.
- Class 32. Beers; mineral and aerated waters and other non-alcoholic beverages; fruit beverages and fruit juices; syrups and other preparations for making beverages; smoothies, fruit beverages and fruit juices, carbonated soft drinks, and energy drinks each containing cannabidiol; smoothies, fruit beverages and fruit juices, carbonated soft drinks, and energy drinks each containing resins and oils containing cannabidiol.
- Class 34. Resins and oils made, derived or extracted from cannabis plants containing cannabidiol for smoking; smokers' articles, namely, smoking pipes, pouches, matches, lighters for smokers, grinders, oral vaporizers for smoking cannabidiol, hemp and derivatives thereof; none of the aforesaid consisting of or containing tobacco.
- Class 35. Advertising; business management; business administration; providing consumer information pertaining to cannabidiol dispensary locations; providing information about the ratings, reviews and recommendations on products and services pertaining to cannabidiol for commercial purposes posted by users via a website; retail and wholesale services, including online retail services, connected with the sale of smoker's articles, oral vaporizers, matches, cosmetics and toiletries containing cannabidiol, foodstuffs and beverages containing cannabidiol, pharmaceuticals, medical and veterinary preparations containing cannabidiol, sanitary preparations containing cannabidiol, dietetic food and substances

- containing cannabidiol adapted for medical or veterinary use, food containing cannabidiol for humans and animals, dietary supplements containing cannabidiol for humans and animals, plasters and materials for dressings containing cannabidiol, non-medicated cosmetics and toiletry preparations containing cannabidiol, perfumery and essential oils containing cannabidiol, natural health products containing cannabidiol, plants, seeds and seedlings, foodstuffs and beverages for animals, foodstuffs and beverages for humans and ingredients for the aforesaid, clothing, headgear and footwear, household or kitchen utensils and containers, cookware and tableware, combs, sponges and brushes, glassware, porcelain and earthenware, paper and printed matter, compact discs, DVDs and other digital recording media, computer software, pharmaceuticals, medical and veterinary preparations, sanitary preparations, dietetic food and substances adapted for medical or veterinary use, food for babies, dietary supplements for humans and animals, plasters, materials for dressings, non-medicated cosmetics and toiletry preparations, perfumery and essential oils.
- Class 39. Transport; packaging and storage of goods; travel arrangement; packaging of products containing cannabidiol and natural health products containing cannabidiol; distribution of cosmetics and toiletries containing cannabidiol, foodstuffs and beverages containing cannabidiol, pharmaceuticals, medical and
- veterinary preparations containing cannabidiol, sanitary preparations containing cannabidiol, dietetic food and substances containing cannabidiol adapted for medical or veterinary use, food containing cannabidiol for humans and animals, dietary supplements containing cannabidiol for humans and animals, plasters and materials for dressings containing cannabidiol, non-medicated cosmetics and toiletry preparations containing cannabidiol, perfumery and essential oils containing cannabidiol and natural health products containing cannabidiol.
- Class 41. Education; providing of training; entertainment; sporting and cultural activities; provision of entertainment information pertaining to cannabidiol culture via a website; providing news via a website in the nature of current event reporting in the field of cannabidiol and cannabidiol culture; provision of educational information pertaining to cannabidiol via a website.
- Class 42. Scientific and technological services and research and design relating thereto; industrial analysis and research services; research services pertaining to cannabidiol, products containing cannabidiol and natural health products containing cannabidiol.
- Class 44. Medical services; veterinary services; hygienic and beauty care for human beings or animals; agriculture, horticulture and forestry services; providing the breeding, growing, cultivation, harvesting and production of plants, seeds

and seedings containing cannabidiol.

- Class 45. Online social networking services for registered users to participate in discussions, get feedback from their peers, from virtual communities, and engage in social networking pertaining to cannabidiol.

APHRIA INC., 265 Talbot Street West, Leamington, Ontario N8H 4H3, Canada. Address for service is c/o TOMKINS & CO., 5 Dartmouth Road, Dublin 6, Ireland.

The application for registration is proceeding with the consent of the Proprietors of Registered European Union Trade Mark No. 017753931.



262465 16 November 2018

- Class 3. Non-medicated cosmetics and toiletry preparations; perfumery, essential oils; bath additives; bath herbs; bath oils; bath oils for cosmetic purposes; beauty care cosmetics; beauty creams for body care; beauty gels; beauty lotions; body and beauty care cosmetics; body creams; body oils; cosmetic creams; cosmetic oils; cosmetics and make-up; face and body lotions; face and body milk; face lotion; hair care preparations; hair styling preparations; hand cream; hand lotions; lip care preparations; lip conditioners; lip glosses; liquid soaps;

massage creams; massage oils; non-medicated bubble bath preparations; non-medicated preparations for the care of hair; non-medicated preparations for the care of skin; non-medicated preparations for the care of the scalp; non-medicated skin care preparations; oils for toiletry purposes; skin care preparations; skin creams; skin emollients; skin lotions; skin soap; soaps for body care; soaps for personal use.

- Class 5. Products containing cannabidiol, namely, oils; oils containing cannabidiol; Products containing cannabidiol, namely oils, salves, concentrated pastes, tinctures, tablets and capsules; oils, salves, concentrated pastes, tinctures, tablets and capsules; nutraceuticals for medicinal purposes; nutraceuticals for medicinal purposes containing cannabidiol; nutraceuticals for medicinal purposes, namely resins and oils containing cannabidiol; topical skin creams, bar and liquid soaps, bath additives, bath herbs, bath oils, body creams, body oils, face and body lotions, face and body milk, face lotion, and skin care preparations each containing cannabidiol; each of the aforementioned products for the relief of pain, for relaxation, for reducing stress and fatigue, for mood enhancement, for maintaining general health and well-being, for relieving anxiety, for relieving depression, as a sleep aid; personal sexual lubricants; transdermal patches containing cannabidiol; oral sprays containing cannabidiol; pharmaceuticals, medical and veterinary preparations; sanitary preparations for

- | | |
|--|---|
| <p>medical purposes; dietetic food and substances adapted for medical or veterinary use, food for babies; dietary supplements for humans and animals; plasters, materials for dressings.</p> <p>Class 9. Compact discs, DVDs and other digital recording media; computer software; electronic publications, namely, newsletters, brochures, reports and guides pertaining to cannabidiol.</p> <p>Class 16. Paper and cardboard; printed matter; photographs; stationery and office requisites, except furniture; drawing materials and materials for artists; instructional and teaching materials; printed publications, namely, newsletters, brochures, reports and guides pertaining to cannabidiol.</p> <p>Class 21. Household or kitchen utensils and containers; cookware and tableware, except forks, knives and spoons; combs and sponges; brushes, except paintbrushes; brush-making materials; glassware, porcelain and earthenware; jars.</p> <p>Class 25. Clothing, footwear, headgear; athletic apparel; baseball caps; beachwear; caps; casual wear; coveralls; flip-flops; gloves; golf caps; golf shirts; hats; headbands; long-sleeved t-shirts; mittens; novelty hats; sandals; shirts; sweatshirts; toques; t-shirts.</p> <p>Class 29. Preserved, frozen, dried and cooked fruits and vegetables; jellies, jams, compotes; milk and milk products; oils and fats for food; edible oils and resins made, derived or extracted from cannabis plants containing cannabidiol; food products, namely butter, containing cannabidiol; food products, namely butter, containing resins made,</p> | <p>derived or extracted from cannabis plants that contain cannabidiol; food products, namely butter, containing oils made, derived or extracted from cannabis plants that contain cannabidiol.</p> <p>Class 30. Coffee, tea, cocoa and artificial coffee; rice; tapioca and sago; flour and preparations made from cereals; bread, pastries and confectionery; edible ices; sugar, honey, treacle; yeast, baking-powder; salt; mustard; vinegar, sauces [condiments]; spices; ice [frozen water]; food products, namely chocolates, cookies, brownies, candy and cereal-based energy bars containing cannabidiol; food products, namely chocolates, cookies, brownies, candy and cereal-based energy bars containing resins made, derived or extracted from cannabis plants containing cannabidiol; food products, namely chocolates, cookies, brownies, candy and cereal-based energy bars containing oils made, derived or extracted from cannabis plants containing cannabidiol; teas, namely teas containing cannabidiol; teas, namely teas containing resins made, derived or extracted from cannabis plants containing cannabidiols; teas, namely teas containing oils made, derived or extracted from cannabis plants containing cannabidiol.</p> <p>Class 31. Raw and unprocessed agricultural, aquacultural, horticultural and forestry products; raw and unprocessed grains and seeds; fresh fruits and vegetables, fresh herbs; natural plants and flowers; bulbs, seedlings and seeds for planting; foodstuffs and beverages for animals; malt.</p> |
|--|---|

- Class 32. Beers; mineral and aerated waters and other non-alcoholic beverages; fruit beverages and fruit juices; syrups and other preparations for making beverages; smoothies, fruit beverages and fruit juices, carbonated soft drinks, and energy drinks each containing cannabidiol; smoothies, fruit beverages and fruit juices, carbonated soft drinks, and energy drinks each containing resins and oils containing cannabidiol.
- Class 34. Resins and oils made, derived or extracted from cannabis plants containing cannabidiol for smoking; smokers' articles, namely, smoking pipes, pouches, matches, lighters for smokers, grinders, oral vaporizers for smoking cannabidiol, hemp and derivatives thereof; none of the aforesaid consisting of or containing tobacco.
- Class 35. Advertising; business management; business administration; providing consumer information pertaining to cannabidiol dispensary locations; providing information about the ratings, reviews and recommendations on products and services pertaining to cannabidiol for commercial purposes posted by users via a website; retail and wholesale services, including online retail services, connected with the sale of smoker's articles, oral vaporizers, matches, cosmetics and toiletries containing cannabidiol, foodstuffs and beverages containing cannabidiol, pharmaceuticals, medical and veterinary preparations containing cannabidiol, sanitary preparations containing cannabidiol, dietetic food and substances containing cannabidiol adapted for medical or veterinary use, food containing cannabidiol for humans and animals, dietary supplements containing cannabidiol for humans and animals, plasters and materials for dressings containing cannabidiol, non-medicated cosmetics and toiletry preparations containing cannabidiol, perfumery and essential oils containing cannabidiol, natural health products containing cannabidiol, plants, seeds and seedlings, foodstuffs and beverages for animals, foodstuffs and beverages for humans and ingredients for the aforesaid, clothing, headgear and footwear, household or kitchen utensils and containers, cookware and tableware, combs, sponges and brushes, glassware, porcelain and earthenware, paper and printed matter, compact discs, DVDs and other digital recording media, computer software, pharmaceuticals, medical and veterinary preparations, sanitary preparations, dietetic food and substances adapted for medical or veterinary use, food for babies, dietary supplements for humans and animals, plasters, materials for dressings, non-medicated cosmetics and toiletry preparations, perfumery and essential oils.
- Class 39. Transport; packaging and storage of goods; travel arrangement; packaging of products containing cannabidiol and natural health products containing cannabidiol; distribution of cosmetics and toiletries containing cannabidiol, foodstuffs and beverages containing cannabidiol, pharmaceuticals, medical and veterinary preparations containing cannabidiol,

sanitary preparations containing cannabidiol, dietetic food and substances containing cannabidiol adapted for medical or veterinary use, food containing cannabidiol for humans and animals, dietary supplements containing cannabidiol for humans and animals, plasters and materials for dressings containing cannabidiol, non-medicated cosmetics and toiletry preparations containing cannabidiol, perfumery and essential oils containing cannabidiol and natural health products containing cannabidiol.

Class 41. Education; providing of training; entertainment; sporting and cultural activities; provision of entertainment information pertaining to cannabidiol culture via a website; providing news via a website in the nature of current event reporting in the field of cannabidiol and cannabidiol culture; provision of educational information pertaining to cannabidiol via a website.

Class 42. Scientific and technological services and research and design relating thereto; industrial analysis and research services; research services pertaining to cannabidiol, products containing cannabidiol and natural health products containing cannabidiol.

Class 44. Medical services; veterinary services; hygienic and beauty care for human beings or animals; agriculture, horticulture and forestry services; providing the breeding, growing, cultivation, harvesting and production of plants, seeds and seedlings containing cannabidiol.

Class 45. Online social networking services for registered users to participate in discussions, get feedback from their peers, from virtual communities, and engage in social networking pertaining to cannabidiol.

Priority Date Claimed: 01 August 2018 Canada

APHRIA INC., 265 Talbot Street West, Leamington, Ontario N8H 4H3, Canada. Address for service is c/o TOMKINS & CO., 5 Dartmouth Road, Dublin 6, Ireland.

The application for registration is proceeding with the consent of the Proprietors of Registered European Union Trade Mark No. 017753931.

BEAM LIGHTING

262466 28 August 2019

Class 11. Light fittings; Lighting and lighting reflectors; Lighting devices for showcases; Lighting elements; Lighting fixtures; Lighting fixtures for commercial use; Lighting fixtures for household use; Lighting for display purposes; Lights for external installation.

Shane Joseph Braniff, 62 Gransha Road, Kircubbin, Newtownards BT22 1AJ, United Kingdom. Address for service is c/o Hanna IP, Block B, The Crescent Building, Northwood, Santry, Dublin 9, Ireland.

MASQT**262467** 17 December 2019

Class 9. Computer software; Computer software platforms; Computer programming software; Computer operating software; Interactive computer software; Computer telephony software; Downloadable computer software; Computer interface software; Computer software [programmes]; Computer software programs; Computer software packages; Recorded computer software; Software (Computer -), recorded; Computer software applications; Computer firewall software; Educational computer software; Computer application software; Software for computers; Network management computer software; Computer software for accessing computer networks; Computer software development tools; Computer programs [downloadable software]; Programs (Computer -) [downloadable software]; Computer search engine software; Computer software for encryption; Computer e-commerce software; Computer programmes; Downloadable computer software applications; Communications processing computer software; Downloadable computer utility software; Computer software for entertainment; Computer software for database management; Computer software for business purposes; Computer software for mobile phones; Computer software for cellular phones; Hardware (Computer -); Computer

hardware; Computers and computer hardware.
 Class 38. Telecommunications; Telecommunications information; Telecommunications consultancy; Telecommunications services; Telecommunications access services; Telecommunications gateway services; Telecommunications portal services; Telecommunications consultancy services; Cellular telecommunications services; Interactive telecommunications services; Mobile telecommunications services; Information about telecommunications; Telecommunications by e-mail; Telecommunications services by satellite; Optical fibre telecommunications services; Fibre optic telecommunications services; Mobile telecommunications network services; Digital network telecommunications services; Rental of telecommunications lines; Operation of telecommunications systems; Transfer of data by telecommunications; Advisory services relating to telecommunications; Consultancy services relating to telecommunications; Information services relating to telecommunications; Operation of a telecommunications network; Telecommunications services between computer networks; Telecommunications services, namely, ISDN services; Professional consultancy relating to telecommunications; Providing telecommunications connections to databases; Transfer of telephone or telecommunications calls; Operation of wide-band telecommunications networks;

Data transmission services over telecommunications networks; Rental of telecommunications apparatus and installations; Telecommunications services using cellular radio networks; Routing and connecting services for telecommunications; Providing telecommunications connections to the Internet; Communication of data by means of telecommunications; Telecommunications services for facsimile transmission of information; Transmission of database information via telecommunications networks; Telecommunications services for the distribution of data; Consulting services in the field of telecommunications; Remote transmission of data by means of telecommunications; Information, consultancy and advisory services relating to telecommunications; Transmission of data by means of telecommunications networks; Providing telecommunications links to the Internet or databases; Providing telecommunications connections to the internet or databases; Provision and rental of telecommunications facilities and equipment; Provision of telecommunications connections for telephone chat lines; Automatic transfer of digital data using telecommunications channels; Providing telecommunications connections to a global computer network; Provision of telephone directory information to assist in telecommunications; Delivery of digital audio and/or video by telecommunications; Telecommunications services provided via the Internet, intranet and extranet;

Telecommunications services, namely intercepting and preventing unsolicited calls from telemarketers; Telecommunications by computer terminals, via telematics, satellites, radios, telegraphs, telephones; Provision of telecommunications links to computer databases and websites on the Internet; Transmission of short messages [SMS], images, speech, sound, music and text communications between mobile telecommunications devices.

Class 42. Software as a service; Software as a service [SAAS] services; Software as a service [SaaS]; Hosting services, software as a service, and rental of software; Consulting services in the field of software as a service [SaaS]; Software as a service [SaaS] featuring computer software platforms for artificial intelligence; Application service provider [ASP], namely, hosting computer software applications of others; Computer software research; Computer software rental; Renting computer software; Computer software maintenance; Computer software development; Developing computer software; Computer software consulting; Computer software consultation; Software design (Computer -); Computer software engineering; Computer software design; Computer and computer software rental; Computer software (Installation of -); Computer software programming services; Configuration of computer software; Writing of computer software; Copying of computer software; Software (Rental of computer

-); Hiring of computer software; Computer software rental services; Leasing of computer software; Repair of computer software; Development of computer software; Computer software consulting services; Computer software consultancy services; Computer software advisory services; Computer software (Design of -); Computer software design services; Design of computer software; Maintenance of computer software; Testing of computer software; Updating of computer software; Installation of computer software; Computer and software consultancy services; Developing and updating computer software; Computer hardware and software design; Computer programming and software design; Computer software design for others; Computer software installation and maintenance; Computer software design and development; Computer software development for others; Computer software technical support services; Writing and updating computer software; Computer software design and updating; Consultancy relating to computer software; Troubleshooting of computer software problems; Development of computer database software; Design of computer database software; Rental of computers and software; Rental of software for computers; Development of computer software application solutions; Hosting computer software applications for others; Computer hardware leasing; Computer hardware rental; Computer hardware development; Computer hardware design.

MASQT Limited, Penrose Wharf Business Centre, 14 Penrose Wharf, Cork, Ireland. Address for service is c/o EIBHLIN O'SULLIVAN, EOS Solicitors, Rubicon, CIT Campus, Bishopstown, Cork, Ireland.

The mark in use is/will be in the colour(s) Rebecca purple, white, black, maastriicht blue, alice blue, red

INSOOL

262468 23 December 2019

Class 5. Veterinary preparations.

Boehringer Ingelheim Vetmedica GmbH, 55218 Ingelheim, Germany, Germany. Address for service is c/o Cruickshank, 8a Sandyford Business Centre, Sandyford, Dublin 18, Ireland.



Application is for a Series of 2 Trade Marks.

262469 13 December 2019

Class 9. Calibration devices; Graduation checkers [calibration checkers]; Measuring apparatus; Measuring instruments; Measuring devices; Measuring sensors; Humidity measuring apparatus; Flow measuring apparatus; Vacuum measuring instruments; Torque measuring apparatus; Resistance measuring instruments; Length measuring gauges; Length measuring apparatus; Digital measuring apparatus; Electricity measuring instruments; Electric measuring devices; Electrical measuring equipment; Electric measuring instruments; Temperature measuring instruments; Pressure measuring apparatus; Instruments for measuring pressure.

Class 42. Calibration services; Calibration [measuring]; Calibration of instruments; Calibration of machines; Calibration services relating to electronic apparatus; Calibration services relating to medical apparatus; Calibration services relating to analytical apparatus.

Priority Date Claimed: 12 December 2019 United Kingdom

Chamois Metrology Ltd., Unit 8, Holywell Business Park, Northfield Road, Southam, Warwickshire CV47 0FP, United Kingdom. Address for service is c/o Chamois Metrology Ltd., Unit 8, Holywell Business Park, Northfield Road, Southam, Warwickshire CV47 0FP, United Kingdom.



262470 16 November 2018

Class 3. Non-medicated cosmetics and toiletry preparations; perfumery, essential oils; bath additives; bath herbs; bath oils; bath oils for cosmetic purposes; beauty care cosmetics; beauty creams for body care; beauty gels; beauty lotions; body and beauty care cosmetics; body creams; body oils; cosmetic creams; cosmetic oils; cosmetics and

- make-up; face and body lotions; face and body milk; face lotion; hair care preparations; hair styling preparations; hand cream; hand lotions; lip care preparations; lip conditioners; lip glosses; liquid soaps; massage creams; massage oils; non-medicated bubble bath preparations; non-medicated preparations for the care of hair; non-medicated preparations for the care of skin; non-medicated preparations for the care of the scalp; non-medicated skin care preparations; oils for toiletry purposes; skin care preparations; skin creams; skin emollients; skin lotions; skin soap; soaps for body care; soaps for personal use.
- Class 5. Products containing cannabidiol, namely, oils; oils containing cannabidiol; Products containing cannabidiol, namely oils, salves, concentrated pastes, tinctures, tablets and capsules; oils, salves, concentrated pastes, tinctures, tablets and capsules; nutraceuticals for medicinal purposes; nutraceuticals for medicinal purposes containing cannabidiol; nutraceuticals for medicinal purposes, namely resins and oils containing cannabidiol; topical skin creams, bar and liquid soaps, bath additives, bath herbs, bath oils, body creams, body oils, face and body lotions, face and body milk, face lotion, and skin care preparations each containing cannabidiol; each of the aforementioned products for the relief of pain, for relaxation, for reducing stress and fatigue, for mood enhancement, for maintaining general health and well-being, for relieving anxiety, for relieving depression, as a
- sleep aid; personal sexual lubricants; transdermal patches containing cannabidiol; oral sprays containing cannabidiol; pharmaceuticals, medical and veterinary preparations; sanitary preparations for medical purposes; dietetic food and substances adapted for medical or veterinary use, food for babies; dietary supplements for humans and animals; plasters, materials for dressings.
- Class 9. Compact discs, DVDs and other digital recording media; computer software; electronic publications, namely, newsletters, brochures, reports and guides pertaining to cannabidiol.
- Class 16. Paper and cardboard; printed matter; photographs; stationery and office requisites, except furniture; drawing materials and materials for artists; instructional and teaching materials; printed publications, namely, newsletters, brochures, reports and guides pertaining to cannabidiol.
- Class 21. Household or kitchen utensils and containers; cookware and tableware, except forks, knives and spoons; combs and sponges; brushes, except paintbrushes; brush-making materials; glassware, porcelain and earthenware; jars.
- Class 25. Clothing, footwear, headgear; athletic apparel; baseball caps; beachwear; caps; casual wear; coveralls; flip-flops; gloves; golf caps; golf shirts; hats; headbands; long-sleeved t-shirts; mittens; novelty hats; sandals; shirts; sweatshirts; toques; t-shirts.
- Class 29. Preserved, frozen, dried and cooked fruits and vegetables; jellies, jams, compotes; milk and milk products; oils and

- fats for food; edible oils and resins made, derived or extracted from cannabis plants containing cannabidiol; food products, namely butter, containing cannabidiol; food products, namely butter, containing resins made, derived or extracted from cannabis plants that contain cannabidiol; food products, namely butter, containing oils made, derived or extracted from cannabis plants that contain cannabidiol.
- Class 30. Coffee, tea, cocoa and artificial coffee; rice; tapioca and sago; flour and preparations made from cereals; bread, pastries and confectionery; edible ices; sugar, honey, treacle; yeast, baking-powder; salt; mustard; vinegar, sauces [condiments]; spices; ice [frozen water]; food products, namely chocolates, cookies, brownies, candy and cereal-based energy bars containing cannabidiol; food products, namely chocolates, cookies, brownies, candy and cereal-based energy bars containing resins made, derived or extracted from cannabis plants containing cannabidiol; food products, namely chocolates, cookies, brownies, candy and cereal-based energy bars containing oils made, derived or extracted from cannabis plants containing cannabidiol; teas, namely teas containing cannabidiol; teas, namely teas containing resins made, derived or extracted from cannabis plants containing cannabidiols; teas, namely teas containing oils made, derived or extracted from cannabis plants containing cannabidiol.
- Class 31. Raw and unprocessed agricultural, aquacultural, horticultural and forestry products; raw and unprocessed grains and seeds; fresh fruits and vegetables, fresh herbs; natural plants and flowers; bulbs, seedlings and seeds for planting; foodstuffs and beverages for animals; malt.
- Class 32. Beers; mineral and aerated waters and other non-alcoholic beverages; fruit beverages and fruit juices; syrups and other preparations for making beverages; smoothies, fruit beverages and fruit juices, carbonated soft drinks, and energy drinks each containing cannabidiol; smoothies, fruit beverages and fruit juices, carbonated soft drinks, and energy drinks each containing resins and oils containing cannabidiol.
- Class 34. Resins and oils made, derived or extracted from cannabis plants containing cannabidiol for smoking; smokers' articles, namely, smoking pipes, pouches, matches, lighters for smokers, grinders, oral vaporizers for smoking cannabidiol, hemp and derivatives thereof; none of the aforesaid consisting of or containing tobacco.
- Class 35. Advertising; business management; business administration; providing consumer information pertaining to cannabidiol dispensary locations; providing information about the ratings, reviews and recommendations on products and services pertaining to cannabidiol for commercial purposes posted by users via a website; retail and wholesale services, including online retail services, connected with the sale of smoker's articles, oral vaporizers, matches, cosmetics and toiletries containing cannabidiol, foodstuffs and beverages containing cannabidiol, pharmaceuticals, medical and

- veterinary preparations containing cannabidiol, sanitary preparations containing cannabidiol, dietetic food and substances containing cannabidiol adapted for medical or veterinary use, food containing cannabidiol for humans and animals, dietary supplements containing cannabidiol for humans and animals, plasters and materials for dressings containing cannabidiol, non-medicated cosmetics and toiletry preparations containing cannabidiol, perfumery and essential oils containing cannabidiol, natural health products containing cannabidiol, plants, seeds and seedlings, foodstuffs and beverages for animals, foodstuffs and beverages for humans and ingredients for the aforesaid, clothing, headgear and footwear, household or kitchen utensils and containers, cookware and tableware, combs, sponges and brushes, glassware, porcelain and earthenware, paper and printed matter, compact discs, DVDs and other digital recording media, computer software, pharmaceuticals, medical and veterinary preparations, sanitary preparations, dietetic food and substances adapted for medical or veterinary use, food for babies, dietary supplements for humans and animals, plasters, materials for dressings, non-medicated cosmetics and toiletry preparations, perfumery and essential oils.
- Class 39. Transport; packaging and storage of goods; travel arrangement; packaging of products containing cannabidiol and natural health products containing cannabidiol; distribution of
- cosmetics and toiletries containing cannabidiol, foodstuffs and beverages containing cannabidiol, pharmaceuticals, medical and veterinary preparations containing cannabidiol, sanitary preparations containing cannabidiol, dietetic food and substances containing cannabidiol adapted for medical or veterinary use, food containing cannabidiol for humans and animals, dietary supplements containing cannabidiol for humans and animals, plasters and materials for dressings containing cannabidiol, non-medicated cosmetics and toiletry preparations containing cannabidiol, perfumery and essential oils containing cannabidiol and natural health products containing cannabidiol.
- Class 41. Education; providing of training; entertainment; sporting and cultural activities; provision of entertainment information pertaining to cannabidiol culture via a website; providing news via a website in the nature of current event reporting in the field of cannabidiol and cannabidiol culture; provision of educational information pertaining to cannabidiol via a website.
- Class 42. Scientific and technological services and research and design relating thereto; industrial analysis and research services; research services pertaining to cannabidiol, products containing cannabidiol and natural health products containing cannabidiol.
- Class 44. Medical services; veterinary services; hygienic and beauty care for human beings or animals; agriculture,

horticulture and forestry services; providing the breeding, growing, cultivation, harvesting and production of plants, seeds and seedlings containing cannabidiol.

- Class 45. Online social networking services for registered users to participate in discussions, get feedback from their peers, from virtual communities, and engage in social networking pertaining to cannabidiol.

APHRIA INC., 265 Talbot Street West, Leamington, Ontario N8H 4H3, Canada. Address for service is c/o TOMKINS & CO., 5 Dartmouth Road, Dublin 6, Ireland.



262471 16 November 2018

- Class 3. Non-medicated cosmetics and toiletry preparations; perfumery, essential oils; bath additives; bath herbs; bath oils; bath oils for cosmetic purposes; beauty care cosmetics; beauty creams for body care; beauty gels; beauty lotions; body and beauty care cosmetics; body creams; body oils; cosmetic creams; cosmetic oils; cosmetics and make-up; face and body lotions; face and body milk; face lotion; hair care preparations; hair styling preparations; hand cream; hand lotions; lip care preparations; lip conditioners; lip glosses; liquid soaps;

massage creams; massage oils; non-medicated bubble bath preparations; non-medicated preparations for the care of hair; non-medicated preparations for the care of skin; non-medicated preparations for the care of the scalp; non-medicated skin care preparations; oils for toiletry purposes; skin care preparations; skin creams; skin emollients; skin lotions; skin soap; soaps for body care; soaps for personal use.

- Class 5. Products containing cannabidiol, namely, oils; oils containing cannabidiol; Products containing cannabidiol, namely oils, salves, concentrated pastes, tinctures, tablets and capsules; oils, salves, concentrated pastes, tinctures, tablets and capsules; nutraceuticals for medicinal purposes; nutraceuticals for medicinal purposes containing cannabidiol; nutraceuticals for medicinal purposes, namely resins and oils containing cannabidiol; topical skin creams, bar and liquid soaps, bath additives, bath herbs, bath oils, body creams, body oils, face and body lotions, face and body milk, face lotion, and skin care preparations each containing cannabidiol; each of the aforementioned products for the relief of pain, for relaxation, for reducing stress and fatigue, for mood enhancement, for maintaining general health and well-being, for relieving anxiety, for relieving depression, as a sleep aid; personal sexual lubricants; transdermal patches containing cannabidiol; oral sprays containing cannabidiol; pharmaceuticals, medical and veterinary preparations; sanitary preparations for

- | | |
|--|---|
| <p>medical purposes; dietetic food and substances adapted for medical or veterinary use, food for babies; dietary supplements for humans and animals; plasters, materials for dressings.</p> <p>Class 9. Compact discs, DVDs and other digital recording media; computer software; electronic publications, namely, newsletters, brochures, reports and guides pertaining to cannabidiol.</p> <p>Class 16. Paper and cardboard; printed matter; photographs; stationery and office requisites, except furniture; drawing materials and materials for artists; instructional and teaching materials; printed publications, namely, newsletters, brochures, reports and guides pertaining to cannabidiol.</p> <p>Class 21. Household or kitchen utensils and containers; cookware and tableware, except forks, knives and spoons; combs and sponges; brushes, except paintbrushes; brush-making materials; glassware, porcelain and earthenware; jars.</p> <p>Class 25. Clothing, footwear, headgear; athletic apparel; baseball caps; beachwear; caps; casual wear; coveralls; flip-flops; gloves; golf caps; golf shirts; hats; headbands; long-sleeved t-shirts; mittens; novelty hats; sandals; shirts; sweatshirts; toques; t-shirts.</p> <p>Class 29. Preserved, frozen, dried and cooked fruits and vegetables; jellies, jams, compotes; milk and milk products; oils and fats for food; edible oils and resins made, derived or extracted from cannabis plants containing cannabidiol; food products, namely butter, containing cannabidiol; food products, namely butter, containing resins made,</p> | <p>derived or extracted from cannabis plants that contain cannabidiol; food products, namely butter, containing oils made, derived or extracted from cannabis plants that contain cannabidiol.</p> <p>Class 30. Coffee, tea, cocoa and artificial coffee; rice; tapioca and sago; flour and preparations made from cereals; bread, pastries and confectionery; edible ices; sugar, honey, treacle; yeast, baking-powder; salt; mustard; vinegar, sauces [condiments]; spices; ice [frozen water]; food products, namely chocolates, cookies, brownies, candy and cereal-based energy bars containing cannabidiol; food products, namely chocolates, cookies, brownies, candy and cereal-based energy bars containing resins made, derived or extracted from cannabis plants containing cannabidiol; food products, namely chocolates, cookies, brownies, candy and cereal-based energy bars containing oils made, derived or extracted from cannabis plants containing cannabidiol; teas, namely teas containing cannabidiol; teas, namely teas containing resins made, derived or extracted from cannabis plants containing cannabidiols; teas, namely teas containing oils made, derived or extracted from cannabis plants containing cannabidiol.</p> <p>Class 31. Raw and unprocessed agricultural, aquacultural, horticultural and forestry products; raw and unprocessed grains and seeds; fresh fruits and vegetables, fresh herbs; natural plants and flowers; bulbs, seedlings and seeds for planting; foodstuffs and beverages for animals; malt.</p> |
|--|---|

- Class 32. Beers; mineral and aerated waters and other non-alcoholic beverages; fruit beverages and fruit juices; syrups and other preparations for making beverages; smoothies, fruit beverages and fruit juices, carbonated soft drinks, and energy drinks each containing cannabidiol; smoothies, fruit beverages and fruit juices, carbonated soft drinks, and energy drinks each containing resins and oils containing cannabidiol.
- Class 34. Resins and oils made, derived or extracted from cannabis plants containing cannabidiol for smoking; smokers' articles, namely, smoking pipes, pouches, matches, lighters for smokers, grinders, oral vaporizers for smoking cannabidiol, hemp and derivatives thereof; none of the aforesaid consisting of or containing tobacco.
- Class 35. Advertising; business management; business administration; providing consumer information pertaining to cannabidiol dispensary locations; providing information about the ratings, reviews and recommendations on products and services pertaining to cannabidiol for commercial purposes posted by users via a website; retail and wholesale services, including online retail services, connected with the sale of smoker's articles, oral vaporizers, matches, cosmetics and toiletries containing cannabidiol, foodstuffs and beverages containing cannabidiol, pharmaceuticals, medical and veterinary preparations containing cannabidiol, sanitary preparations containing cannabidiol, dietetic food and substances containing cannabidiol adapted for medical or veterinary use, food containing cannabidiol for humans and animals, dietary supplements containing cannabidiol for humans and animals, plasters and materials for dressings containing cannabidiol, non-medicated cosmetics and toiletry preparations containing cannabidiol, perfumery and essential oils containing cannabidiol, natural health products containing cannabidiol, plants, seeds and seedlings, foodstuffs and beverages for animals, foodstuffs and beverages for humans and ingredients for the aforesaid, clothing, headgear and footwear, household or kitchen utensils and containers, cookware and tableware, combs, sponges and brushes, glassware, porcelain and earthenware, paper and printed matter, compact discs, DVDs and other digital recording media, computer software, pharmaceuticals, medical and veterinary preparations, sanitary preparations, dietetic food and substances adapted for medical or veterinary use, food for babies, dietary supplements for humans and animals, plasters, materials for dressings, non-medicated cosmetics and toiletry preparations, perfumery and essential oils.
- Class 39. Transport; packaging and storage of goods; travel arrangement; packaging of products containing cannabidiol and natural health products containing cannabidiol; distribution of cosmetics and toiletries containing cannabidiol, foodstuffs and beverages containing cannabidiol, pharmaceuticals, medical and veterinary preparations containing cannabidiol,

sanitary preparations containing cannabidiol, dietetic food and substances containing cannabidiol adapted for medical or veterinary use, food containing cannabidiol for humans and animals, dietary supplements containing cannabidiol for humans and animals, plasters and materials for dressings containing cannabidiol, non-medicated cosmetics and toiletry preparations containing cannabidiol, perfumery and essential oils containing cannabidiol and natural health products containing cannabidiol.

Class 41. Education; providing of training; entertainment; sporting and cultural activities; provision of entertainment information pertaining to cannabidiol culture via a website; providing news via a website in the nature of current event reporting in the field of cannabidiol and cannabidiol culture; provision of educational information pertaining to cannabidiol via a website.

Class 42. Scientific and technological services and research and design relating thereto; industrial analysis and research services; research services pertaining to cannabidiol, products containing cannabidiol and natural health products containing cannabidiol.

Class 44. Medical services; veterinary services; hygienic and beauty care for human beings or animals; agriculture, horticulture and forestry services; providing the breeding, growing, cultivation, harvesting and production of plants, seeds and seedlings containing cannabidiol.

Class 45. Online social networking services for registered users to participate in discussions, get feedback from their peers, from virtual communities, and engage in social networking pertaining to cannabidiol.

Priority Date Claimed: 01 August 2018 Canada

APHRIA INC., 265 Talbot Street West, Leamington, Ontario N8H 4H3, Canada. Address for service is c/o TOMKINS & CO., 5 Dartmouth Road, Dublin 6, Ireland.

The application for registration is proceeding with the consent of the Proprietors of Registered European Union Trade Mark No. 017753931.



262472 08 December 2019

Class 25. Hats.
Class 40. Wood-working;
Woodworking.

Samson Njuguna, 30 Saint Coleman's Place, Buttevant, Co. Cork, P51 X2W0, Ireland. Address for service is c/o samson njuguna, 30 Saint Coleman's Place, Buttevant P51 X2W0, Ireland.

The mark in use is/will be in the colour(s) black and white.

Celtic Rover

262473 31 December 2019

- Class 12. Motorcycles; Motorcycle saddlebags; Motorcycle tires; Motorcycle frames; Motorcycle chains; Motorcycle handlebars; Motorcycle engines.
- Class 25. Motorcycle jackets; Motorcycle gloves.

Anthony Keating, 64a Moss Road, Wigan WN5 7BT, United Kingdom. Address for service is c/o Anthony Keating, 64a Moss Road, Wigan WN5 7BT, United Kingdom.

Celtic Cycle Company Dublin

262474 31 December 2019

- Class 12. Motorcycles.

Anthony Keating, 64a Moss Road, Wigan WN5 7BT, United Kingdom. Address for service is c/o Anthony Keating, 64a Moss Road, Wigan WN5 7BT, United Kingdom.

#positivityfuel

#PositivityFuel

Application is for a Series of 2 Trade Marks.

262475 02 January 2020

- Class 30. Confectionery; chocolates; chocolate-based products.
- Class 35. Marketing services; public relation services; advertising; advice in relation to marketing; preparation of advertisements; placing advertisements for others; promoting the sale of goods and services on behalf of others by arranging advertisements; advising and arrangement of promotional material; consultancy, advisory and information services for or in relation to any or all of the aforementioned services in this Class.
- Class 42. Design services; design of marketing material; design of promotional material; design of advertisements; design of printed matter for use in marketing; design of marketing material for use in the marketing of retail services; design of marketing material for use in the marketing and promotion of confectionery, chocolates and chocolate-based products; consultancy, advisory and information services for or in relation to any or all of the aforementioned services in this Class.

Priority Date Claimed: 10 July 2019 United Kingdom

Ritter Sport Chocolate UK Ltd, 1 City Square, Leeds, West Yorkshire LS1 2ES, United Kingdom. Address for service is c/o Tomkins & Co, 5 Dartmouth Road, Dublin 6, Ireland.

Priority Date Claimed: 03 July 2019 United Kingdom

Ritter Sport Chocolate UK Ltd, 1 City Square, Leeds, West Yorkshire LS1 2ES, United Kingdom. Address for service is c/o Tomkins & Co, 5 Dartmouth Road, Dublin 6, Ireland.

Positivity Fuel

262476 02 January 2020

- Class 30. Confectionery; chocolates; chocolate-based products.
- Class 35. Marketing services; public relation services; advertising; advice in relation to marketing; preparation of advertisements; placing advertisements for others; promoting the sale of goods and services on behalf of others by arranging advertisements; advising and arrangement of promotional material; consultancy, advisory and information services for or in relation to any or all of the aforementioned services in this Class.
- Class 42. Design services; design of marketing material; design of promotional material; design of advertisements; design of printed matter for use in marketing; design of marketing material for use in the marketing of retail services; design of marketing material for use in the marketing and promotion of confectionery, chocolates and chocolate-based products; consultancy, advisory and information services for or in relation to any or all of the aforementioned services in this Class.

TWHEELER



262477 05 December 2019

- Class 25. Clothing; Motorcycle jackets; Motorcycle rain suits; Motorcycle riding suits; Motorcycle gloves.

TWHEELER - TAILORED URBAN GEAR LIMITED, The Black Church, St. Mary's Place, Dublin 7, Ireland. Address for service is c/o TWHEELER - TAILORED URBAN GEAR LIMITED, c/o Joao Barquinha, Rua Viriato, n°2 - 6°D, 1050-235 Lisboa / Portugal, Portugal.

Beal Na Blath Gin

262478 20 December 2019

- Class 33. Gin.

Stephen King, 9 Tramway Tce, Douglas, Cork T12YP23, Ireland. Address for service is c/o Stephen King, 9 Tramway Tce, Douglas, Cork T12YP23, Ireland.

Fort Camden Gin

262479 20 December 2019

Class 33. Gin.

Stephen King, 9 Tramway Tce, Douglas, Cork T12YP23, Ireland. Address for service is c/o Stephen King, 9 Tramway Tce, Douglas, Cork T12YP23, Ireland.

RCYC 1720 Whiskey

262480 20 December 2019

Class 33. Whiskey.

Stephen King, 9 Tramway Tce, Douglas, Cork T12YP23, Ireland. Address for service is c/o Stephen King, 9 Tramway Tce, Douglas, Cork T12YP23, Ireland.

RCYC Whiskey

262481 20 December 2019

Class 33. Whiskey.

Stephen King, 9 Tramway Tce, Douglas, Cork T12YP23, Ireland. Address for service is c/o Stephen King, 9 Tramway Tce, Douglas, Cork T12YP23, Ireland.

Mulroy Bay Poitin

Mulroy Bay Gin

Mulroy Bay Whiskey

Mulroy Bay Rum

Mulroy Bay Vodka

Mulroy Bay Cream

Application is for a Series of 6 Trade Marks.

262482 19 November 2019

Class 33. Distilled spirits.

Baioilleach Teoranta, Gortnabrade, Carrigart, Co. Donegal, Ireland. Address for service is c/o Baioilleach Teoranta, c/o Michael R O Boyle, Gortnabrade, Carrigart, Co. Donegal, Ireland.

VOGUE INSPIRED BY YOU**262483** 30 December 2019

Class 34. Cigarettes; tobacco, raw or manufactured; roll your own tobacco; pipe tobacco; tobacco products; tobacco substitutes (not for medical purposes); cigars; cigarillos; cigarette lighters; cigar lighters; matches; smokers' articles; cigarette paper; cigarette tubes; cigarette filters; pocket apparatus for rolling cigarettes; hand held machines for injecting tobacco into paper tubes; electronic cigarettes; liquids for electronic cigarettes; tobacco products for the purpose of being heated.

American-Cigarette Company (Overseas) Limited,
Route de France 17, Boncourt 2926, Switzerland.
Address for service is c/o Tomkins & Co, 5
Dartmouth Road, Dublin 6, Ireland.

**262484** 30 December 2019

Class 18. Dog clothing; Dog apparel;
Dog coats; Dog leashes; Dog

leads; Dog collars; Clothing for dogs; Coats for dogs; Rawhide chews for dogs; Raincoats for pet dogs.

Class 28. Dog toys; Toys for dogs.

Class 31. Biscuits (Dog -); Dog food; Dog foods; Dogs; Dog biscuits; Biscuits for dogs; Food for dogs; Foodstuffs for dogs; Foodstuff for dogs; Bones for dogs; Beverages for dogs; Canned foods for dogs; Pet food for dogs; Food preparations for dogs; Edible chews for dogs; Chewing bones for dogs.

Richard Marles, Lakeview House, Kippenstown, Ballykeeran, Athlone, Co. Westmeath N37 W956, Ireland. Address for service is c/o Richard Marles, Lakeview House, Kippenstown, Ballykeeran, Athlone, Co. Westmeath N37 W956, Ireland.

The mark in use is/will be in the colour(s) Green, White & Blue

1601 Kingsale whiskey**1601 Kingsale gin**

Application is for a Series of 2 Trade Marks.

262485 30 December 2019

Class 33. Spirits

Stephen King, 9 Tramway Terrace, Douglas, Cork T12YP23, Ireland. Address for service is c/o Stephen King, 9 Tramway Terrace, Douglas, Cork T12YP23, Ireland.



Application is for a Series of 1 Trade Marks.

262486 01 August 2019

Class 41. Education services relating to the development of childrens' mental faculties; Vocational education; Vocational guidance; Training; Employment training; Training courses; Providing training; Training services; Practical training; Personal development training; Vocational training services; Education and training; Teacher training services; Organisation of training; Career and vocational training.

Blossom Ireland, 2nd Floor, Raheny Shopping Centre, Howth Road, Dublin D05 K718, Ireland. Address for service is c/o Blossom Ireland, 2nd Floor, Raheny Shopping Centre, Howth Road, Dublin D05 K718, Ireland.



Application is for a Series of 2 Trade Marks.

262487 23 December 2019

Class 16. Stationery; greeting cards, gift cards, invitation cards; gift wrapping paper, gift bags and gift boxes; diaries; photo albums; notebooks; calendars; address books; birthday books; prints; gift tags; stickers; jotter boxes; memo pads; reminder books; notecards and notelets; writing paper and envelopes; paper pads; note paper; tissue paper; binders; paper party tableware; pens; pencils; craft kits for decorating with paper; containers for pencils and for pens; boxes made of paper or cardboard; party accessories made of paper; pencil holders, pencil sharpeners, pen holders, tissue envelopes, posters, paintings, advent calendars, growth charts; adhesives for stationery or household purposes; artists' materials; paint brushes; gift ribbons and bows; streamers, paper serviettes; paper napkins, paper table cloths/covers, paper table runners, paper or cardboard door decorations and paper or cardboard table decorations;

cardboard or paper place cards; cardboard or paper napkin holders.

Aldi Stores (Ireland) Limited, 67-68 Fitzwilliam Square, Dublin 2, Ireland. Address for service is c/o FRKelly, 27 Clyde Road, Ballsbridge, Dublin 4, Ireland.

Old Ironsides Gin

Old Ironsides Whiskey

Application is for a Series of 2 Trade Marks.

262488 20 December 2019

Class 33. Spirits.

Stephen King, 9 Tramway Tce, Douglas, Cork T12YP23, Ireland. Address for service is c/o Stephen King, 9 Tramway Tce, Douglas, Cork T12YP23, Ireland.

Celtic Cycle Company

262489 31 December 2019

Class 12. Motorcycles; Motorcycle engines; Motorcycle handlebars; Motorcycle chains; Motorcycle frames; Motorcycle saddles; Motorcycle kickstands; Motorcycle foot pegs; Shock

absorbers for motorcycles; Luggage racks for motorcycles; Structural parts for motorcycles; Front forks for motorcycles; Handle bar grips [parts of motorcycles].

Anthony Keating, 64A Moss Road, Wigan WN5 7BT, United Kingdom. Address for service is c/o Anthony Keating, 64A Moss Road, Wigan WN5 7BT, United Kingdom.

1601 Black Barrel Whiskey

262490 20 December 2019

Class 33. Whiskey.

Stephen King, 9 Tramway Tce, Douglas, Cork T12YP23, Ireland. Address for service is c/o Stephen King, 9 Tramway Tce, Douglas, Cork T12YP23, Ireland.



262491 10 December 2019

Class 41. Training courses.

Derek McDonnell, 5 Cleggan Road, Ballyfermot, Dublin 10, Ireland. Address for service is c/o Derek McDonnell, 5 Cleggan Road, Ballyfermot, Dublin 10, Ireland.



early
childhood
ireland



Application is for a Series of 2 Trade Marks.

262492 29 August 2019

Class 9. Computer software; educational computer software; Computer software (recorded); downloadable computer software; Computer software for mobile phones; publications in electronic form supplied on-line from a database or from facilities provided on the Internet or other network including websites; downloadable

fiction and non-fiction books, booklets, magazines and publications on a variety of topics; animated films and videos; computer programs featuring interactive games and stories; computer programs featuring movie clips and art; computer programs in the nature of an interactive multimedia database featuring entertainment and educational information; CD-ROM discs featuring pre-recorded entertainment, music and educational information; audio discs and tape cassettes featuring pre-recorded entertainment, music and educational information; data recordings including audio, compact disc, CD-ROM, DVD, podcasts, still and moving images and text; computer software, including software for use in downloading, storing, reproducing and organising audio, compact disc, CD-ROM, DVD, still and moving images and data; digital media, namely downloadable audio files and downloadable audio and video recordings featuring educational and entertainment content; downloadable video recordings; downloadable educational media; downloadable publications; downloadable electronic publications; audio books; audio disks and cassettes featuring pre-recorded entertainment; downloadable fiction or non-fiction books, booklets, magazines and publications on a variety of topics; computer programs in the nature of an interactive multimedia database featuring entertainment and educational information; computer games software; mouse pads; electronic instructional and

teaching apparatus and instruments; computer software for mobile phones; computer software in the form of an app for mobile devices and computers; mobile phone applications; mobile phone games; social media applications; interactive multimedia software for playing games; interactive multimedia computer games programmes; downloadable interactive entertainment software for playing computer games; interactive databases; interactive software; interactive compact discs; interactive DVDs; interactive multimedia computer software; educational mobile applications; educational computer applications; educational tablet applications; children's education software; virtual reality software for education; augmented reality software for education; decorative magnets; fridge magnets; games software; interactive multimedia computer game programs; games software downloadable to mobile phones, tablets and other electronic mobile devices; downloadable software for video games; electronic game programs; electronic game software; electronic game software for wireless devices; interactive video game programs; video and computer game programs; apps featuring computer games; social media applications; interactive databases; interactive terminals; interactive DVDs; interactive video apparatus; interactive computer systems; interactive graphic screens; interactive video game programs; interactive touch screen programs; interactive software; interactive compact

discs; interactive DVD's; interactive multimedia downloadable computer software in the fields of educational, sports, health, nutrition and education.

Class 16. Paper; cardboard; printed matter; publications; printed publications; books; educational books; educational and instructional material; instructional and teaching materials; scrap books; picture books; book marks; drawing pads; drawing and painting materials, apparatus and instruments; paper folders; desk pads; annuals; booklets; calendars; cards; manuals; catalogues; maps; illustrated wall maps for educational purposes; charts; posters; paintings; drawings; photographs; prints; pictures; paper and plastic bags; writing pads; note pads; notebooks; writing instruments and materials; paint kits [arts and crafts]; paintbrushes; paint kits; journals; brochures; newsletters; magazines; periodicals; programs; pamphlets; journals; daily planners; educational and instructional materials; paint books [colour charts]; paint books [printed matter]; colour cards; decalcomanias, materials for modelling; three dimensional models for educational purposes; educational paper signs; banners; printed advertising and promotional materials; atlases; globes; graphic images; graphic reproductions; paper party goods and paper party decorations; paper tablecloths and table covers; paper mats; paper party streamers.

Class 25. Clothing; footwear; headgear; t-shirts; long-sleeved t-shirts; polo shirts; shirts; sweatshirts; zipped sweatshirts; jumpers;

- cardigans; jackets; hoodies; zipped sweatshirts; articles of outer-clothing; pants; shorts; socks; trousers; visors; hats; caps; baseball caps; belts; gloves; scarves and neckwear; waterproof clothing; pyjamas; nightwear; sleeping suits; romper suits; baby-gros; baby clothes; vests; mittens; aprons; uniforms; uniforms for commercial use.
- Class 28. Toys; educational toys; educational playthings; toys adapted for educational purposes; games; playthings; playing cards; dice; dice games; cups for dice; teddy bears; dolls; card games; mats for games; board games; electronic toys and electronic games; electronic educational teaching games; electronic educational games for children; toy bicycles; soft toys; rattles; baby toys; balloons; puppets; puzzles; jigsaw puzzles; squeezable balls used to relieve stress; playground equipment; modular play centres consisting of panels, decks, platforms, handrails, slides and steps, all sold separately or in selected combination; water slides; children's toy bicycles and scooters; playhouses; sandboxes; paddling pools; trampolines; climbing frames; balls; squeaky toys; toys made of rope; carnival and theatrical masks; toy dogs; gymnastic and sporting articles; Indoor fitness apparatus; balls for games; elbow and knee guards (sports articles); kites; gloves for games; tables for table tennis; novelties for parties; rackets; christmas trees of synthetic material; decorations for christmas trees; bags specially adapted for sports equipment; Exercise balls; swimming flippers; swimming jackets; swimming belts;
- swimming floats; swimming equipment; controllers for game consoles; appliances for physical exercise or gymnastics; scooters [toys]; protective paddings (part of sport suits); models being toys; Toy figurines; children's play cosmetics; apparatus for games adapted for use with television receivers only; video game interactive control floor pads or mats; parts and fittings for the aforesaid goods.
- Class 35. Retail services (including online retail services) and wholesale services relating to entertainment and educational supplies; Retail services, including online retail services, relating to education and educational materials and supplies; wholesale services in relation to educational materials and supplies; Retail services, including online retail services, relating to educational goods, namely computer software, educational computer software, computer software (recorded), downloadable computer software, computer software for mobile phones, publications in electronic form supplied on-line from a database or from facilities provided on the Internet or other network including websites, fiction and non-fiction books, booklets, magazines and publications in software form, animated films and videos, computer programs featuring interactive games and stories, computer programs featuring movie clips and art, computer programs in the nature of an interactive multimedia database featuring entertainment and educational information, CD-ROM discs featuring pre-recorded entertainment, music and

educational information, audio discs and tape cassettes featuring pre-recorded entertainment, music and educational information, data recordings including audio, compact disc, CD-ROM, DVD, podcasts, still and moving images and text, computer software, including software for use in downloading, storing, reproducing and organising audio, compact disc, CD-ROM, DVD, still and moving images and data, digital media, namely downloadable audio files and downloadable audio and video recordings featuring educational and entertainment content, downloadable video recordings, downloadable educational media, downloadable publications, downloadable electronic publications, audiobooks, audio disks and cassettes featuring pre-recorded entertainment, fiction or non-fiction books, booklets, magazines and publications in software form, computer programs in the nature of an interactive multimedia database featuring entertainment and educational information, computer games software, mouse pads, electronic instructional and teaching apparatus and instruments, computer software for mobile phones, computer software in the form of an app for mobile devices and computers, mobile phone applications, mobile phone games, social media applications, interactive games, interactive databases, interactive software, interactive compact discs, interactive DVDs, interactive multimedia computer software, educational mobile applications, educational

computer applications, educational tablet applications, children's education software, virtual reality software for education, augmented reality software for education, decorative magnets, fridge magnets, games software, apparatus for games adapted for use with television receivers only, interactive multimedia computer game programs, games software downloadable to mobile phones, tablets and other electronic mobile devices, downloadable software for video games, electronic game programs, electronic game software, electronic game software for wireless devices, interactive video game programs, video and computer game programs, video game interactive control floor pads or mats, apps featuring computer games, social media applications, interactive games, interactive databases, interactive products for computers, interactive software, interactive compact discs, interactive DVDs, interactive multimedia downloadable computer software in the fields of educational, sports, health, nutrition and education; Retail services, including online retail services, relating to educational goods, namely paper and paper related goods, namely paper, cardboard, printed matter, publications, printed publications, books, educational books, educational and instructional material, instructional and teaching materials, scrap books, picture books, book marks, drawing pads, drawing and painting materials, apparatus and instruments, paper folders, desk pads, annuals, booklets, calendars, cards, manuals, catalogues,

maps, illustrated wall maps for educational purposes, charts, posters, paintings, drawings, photographs, prints, pictures, paper and plastic bags, writing pads, note pads, note books, writing instruments and materials, paints, paintbrushes, paint kits, journals, brochures, newsletters, magazines, periodicals, programs, pamphlets, journals, daily planners, educational and instructional materials, paint books [colour charts], paint books [printed matter], colour cards, decalcomanias, materials for modelling, three dimensional models for educational purposes, educational paper signs, banners, advertising and promotional materials, atlases, globes, graphic images, graphic reproductions, paper party goods and paper party decorations, paper tablecloths and table covers, paper mats; paper party streamers; Retail services, including online retail services, relating to clothing, footwear and headgear; Retail services, including online retail services, relating to games and toys, namely educational toys, educational playthings, toys adapted for educational purposes, games, playthings, playing cards, dice, dice games, cups for dice, teddy bears, dolls, card games, mats for games, board games, electronic toys and electronic games, electronic educational teaching games, electronic educational games for children, toy bicycles, soft toys, bean bags, rattles, baby toys, balloons, puppets, puzzles, jigsaw puzzles, squeezable balls used to relieve stress, playground equipment, modular play centres consisting of panels,

decks, platforms, handrails, slides and steps all sold separately or in selected combination, water slides, children's toy bicycles and scooters, playhouses, sandboxes, paddling pools, trampolines, climbing frames, balls, squeaky toys, toy rope items, carnival and theatrical masks, toy dogs, gymnastic and sporting articles, Indoor fitness apparatus, balls for games, elbow and knee guards (sports articles), kites, gloves for games, tables for table tennis, novelties for parties, rackets, christmas trees of synthetic material, decorations for christmas trees, bags specially adapted for sports equipment, exercise balls, swimming flippers, swimming jackets, swimming belts, swimming floats, swimming equipment, controllers for game consoles, appliances for physical exercise or gymnastics, scooters [toys], protective paddings (part of sport suits), models being toys, toy figurines, children's play cosmetics, parts and fittings for the aforesaid goods; advertising; marketing; advertising services, namely promoting of goods and services; advertising and marketing services; advertising and marketing services provided by means of indirect methods of marketing communications, namely social media; internet marketing; mobile marketing and other forms of passive; sharable or viral communication channels; on-line advertising via a computer network; online marketing; sales promotions for others; advertising services namely promoting the brands, goods or services of others; endorsement services, namely endorsing

the brands, goods and services of others; provision of social media strategy and marketing; provision of advertising and marketing services provided by means of indirect methods of marketing communications, namely social media; planning and development of marketing by means of social media; presentation of goods on communications media, for retail purposes; preparation of publicity materials; promoting the goods and services of others by providing links to the websites of others; dissemination of advertising and promotional materials; organisation of exhibitions for commercial or advertising purposes; franchising services providing business assistance; business advisory services relating to franchising; management advisory services related to franchising; provision of business advice and information relating to franchising; commercial management assistance in relation to franchises; business advertising services relating to franchising; provision of business information relating to franchising; business management assistance in the field of franchising; business management advisory services relating to franchising; business advisory services in relation to franchising; business assistance relating to franchising; management advisory services related to franchising; business advice and consultancy relating to franchising ; business information provided online from a computer database or the internet; business management; business administration; office functions; business management consultancy;

assistance and advice in the field of childhood education, learning, policy and advocacy; information services relating to jobs and career opportunities in the childhood education and learning sector; career advisory services (other than education and training advice); job placement services; job matching services; writing of publicity texts; promoting the goods by providing a website and mobile applications; promoting the goods, products and services by telephone, by text or other electronic communication means including the Internet; product reviews; demonstration of goods; distribution of samples; exhibitions for commercial or advertising purposes; human resources management; human resources management and recruitment services; human resources consultancy; serving as a human resources department for others; information, consultancy and advisory services related to the aforesaid services.

Class 36.

Charitable collections; charitable fundraising; electronic funds transfers; electronic payment services; payment administration services; automated payment services; digital payment services; remote payment services; consultancy relating to educational financial assistance; provision of educational scholarships.

Class 41.

Education; educational services; online educational services; education and instruction services; provision of training; provision of facilities for educational training; arranging of presentations for educational purposes; organisation of seminars and conferences;

arranging and conducting of seminars, conferences and workshops; educational services relating to childhood education and learning; educational seminars relating to childhood education and learning; training courses related to childhood education and learning; training of staff in the care of children; organisation of educational webinars; internet conferencing services; organising and conducting of educational seminars, conferences, conventions, exhibitions, fora, symposiums, colloquia and workshops; conducting of organisation of educational webinars; internet conferencing services; arranging competitions; children's educational services; production of educational sound and video recordings; further education; education examination and testing services; educational instruction; educational research; educational consultancy; educational services in relation to early childhood and childcare; educational services in relation to policy; training; advocacy and the provision of information regarding that sector; educational services relating to early childhood education and policy; educational seminars relating to early childhood education and policy; training courses related to early childhood education and policy; instruction in early childhood education and policy; providing a website featuring nondownloadable publications in the field of early childhood education and policy; education services, namely, providing classes and instruction in the field of early

childhood education and policy; publication of educational material; publication of educational texts; publication of educational books; publication of educational matter; publication of educational teaching materials; publication of educational policies; publication of educational and training guides; audio-visual display presentation services for educational purposes; publishing of educational training texts on early childhood policy; distribution of printed educational materials; providing a website featuring nondownloadable publications in the field of childhood education and learning information; providing a website featuring non-downloadable publications in the field of childhood education and learning policy; practical training (demonstration); advisory services relating to childhood education and learning; education services; video education services; online education services; publication of education and training materials; providing online electronic publications in the nature of books, booklets, magazines, ezines, newsletters, informational leaflets, informational pamphlets, informational flyers and informational notices in the field of advice about childhood education and learning; publication of books; texts and magazines; electronic online publication of periodicals and books; electronic publication (non downloadable); online publication of electronic books and magazines (non downloadable); providing electronic publication and

editing of printed matter; operation of blogs; operation of vlogs; writing services for blogs; publication services, namely, publication of blogs and vlogs; broadcasting services, namely, broadcasting of blogs and vlogs; provision of blogging services; provision of vlogging services; production and publication of video recordings; production of sound and video recordings for use in management educational training; provision of news and news information via a computer network and/or the Internet; rental; leasing or hiring of educational materials or apparatus; preschool teaching; pre-school education; pre-school educational services; nursery school educational services; advice and information on pre-school and nursery school services; educational services providing instruction in childhood learning policy; accreditation of educational achievements; vlogging services; blogging services; providing a website featuring blogs; publication services namely the publication of electronic journals; writing of texts including publicity texts; entertainment services; entertainment services namely providing online videos (nondownloadable); entertainment services in the nature of television and multimedia program series featuring subjects of general human interest distributed via various platforms across multiple forms of transmission media; providing entertainment information to others via a global computer network; organisation of educational activities; conducting classes in nutrition; physical education

services; sporting education services; educational services related to sports and physical fitness; educational policy development services relating to sports and physical fitness; conducting classes in exercise; consultancy services relating to training; education services relating to health; educational services relating to physical fitness; instruction courses relating to sporting activities; instruction courses relating to physical fitness; instruction courses relating to health; exercise instruction; Instruction in sporting activities; physical fitness instruction; provision of courses of instruction relating to sport; sports tuition; coaching and instruction; educational services related to physical fitness and mental well-being; provision of educational health and fitness information; providing on-line fitness instruction and classes (non-downloadable); arranging and conducting of competitions, including competitions relating to sports; scheduling of sporting events; provision of educational health and fitness information; providing of training; providing of training in the fields of early childhood education and policy; providing non-downloadable electronic publications relating to early childhood education and policy; providing nondownloadable electronic publications relating to nutrition, weight loss, body training and fitness training; arranging of demonstrations for training purposes; organising, producing and presenting cultural, entertainment and sporting events; organizing, producing and presenting competitions,

contests, games, exhibitions, shows and fundays; career advisory services; career information and advisory services (educational and training advice); provision of training courses for preparation for careers relating to childhood education; learning and policy; consultancy and advisory services related to the above.

- Class 43. Creche services; day nursery services; providing information about creche services; providing information about nursery services; provision of pre-school care; provision of day nurseries; consultancy and advisory services related to the above.

ECCE & PLAY EARLY CHILDHOOD IRELAND TRADING AS EARLY CHILDHOOD IRELAND, Hainault House, Belgard Square South, Tallaght, Dublin 24, Ireland. Address for service is c/o Ping Bai, c/o CROWLEY MILLAR SOLICITORS, 2/3 Exchange Place, George's Dock, IFSC, Dublin 1, Ireland.

The first mark of the series in use is/will be in the colours grey and orange. The second mark in the series in use is/will be in the colours white, orange and grey.



262493 19 November 2019

Class 44. Mental health services.

Stress Control Ltd., 44 Ravenswood Drive, Glasgow G41 3QS, United Kingdom. Address for service is c/o Stress Control Ltd., 44 Ravenswood Drive, Glasgow G41 3QS, United Kingdom.

The mark in use is/will be in the colour(s) as attached logo



262494 19 December 2019

Class 29. Meat-based snack foods.

Matthew Brownie, Coolnagranne, Skibbereen, Cork P81K330, Ireland. Address for service is c/o Matthew Brownie, Coolnagranne, Skibbereen, Cork P81K330, Ireland.

The mark in use is/will be in the colour(s) Black, White, Red, Yellow, Orange, Blue,

MEDIAHUIS

262495 01 October 2019

Class 16. Printed matter; printed publications; newspapers; magazines; periodicals;

- stationery; calendars; diaries; books; greeting cards; post cards; art prints; works of art; catalogues; pictures; newsletters; instructional and teaching materials.
- Class 35. Advertising, marketing and promotional services; retail services, online retail services and mail order retail services in connection with the sale of photographic media, multimedia recordings, downloadable computer software applications for use with mobile devices, including smart phones and tablet computers, sound recording and sound reproducing apparatus and instruments, video recording and video producing apparatus and instruments, electronic publications (downloadable), printed matter, printed publications, newspapers, magazines, periodicals, stationery, calendars, diaries, books, greeting cards, post cards, art prints, works of art, catalogues, pictures, newsletters and instructional and teaching materials; online information services, namely, providing information containing curated and original text, audio content, images, photographs and video content in the field of careers via a web site.
- Class 38. Broadcasting services; broadcasting and transmission of text, messages, information, sound and images; transmission of radio and television programmes, text, messages, information, sound and images via communication and computer networks; computer aided transmission of information, messages, text, sound, images, data and radio and television programmes; broadcasting and transmission of digital information by means of cable, wire or fibre; receiving and exchanging of information, text, messages, sound, images and data; electronic mail services; news information and news agency services; message sending; gateway services for access to a communications or computer network; retrieval, provision and display of information from a computer stored databank; electronic display of information, messages, text, images and data; information, advisory and consultancy services in relation to the aforesaid services.
- Class 41. Electronic publication; electronic publication of texts and printed matter, other than publicity texts, on the Internet; electronic publication services; publication and editing of printed matter; publication of printed matter in electronic form; publication services; newspaper publishing; newspaper publication; online publication of electronic newspapers; publication of newspapers, periodicals, catalogs and brochures; publication of newspapers; multimedia publishing of magazines, journals and newspapers; news programming services for transmission across the Internet; news reporter services; news reporting; provision of news relating to sport; news reporting services; provision of entertainment via podcast; entertainment; provision of entertainment information by electronic means; digital video, audio and multimedia entertainment publishing services; organisation of entertainment and cultural events; entertainment services in the

nature of arranging social entertainment events; organising competitions; arranging and conducting award ceremonies; online information services, namely, providing information containing curated and original text, audio content, images, photographs and video content in the field of news, sport, current affairs, culture, the media, entertainment, lifestyle, books, and the arts via a web site.

- Class 42. Design and development of software, including applications for the benefit of social media; designing websites for third parties; programming software for internet platforms; hosting platforms on the internet; graphic design.

MEDIAHUIS, Mediahuis NV, Katwilgweg 2, 2050 Antwerpen, Belgium. Address for service is c/o MACLACHLAN & DONALDSON, Unit 10, 4075 Kingswood Road, Citywest Business Campus, Dublin 24 D24 C56E, Ireland.



262496 01 October 2019

- Class 16. Printed matter; printed publications; newspapers; magazines; periodicals; stationery; calendars; diaries; books; greeting cards; post cards; art prints; works of art; catalogues; pictures; newsletters; instructional and teaching materials.

- Class 35. Advertising, marketing and promotional services; retail services, online retail services and mail order retail services in connection with the sale of photographic media, multimedia recordings, downloadable computer software applications for use with mobile devices, including smart phones and tablet computers, sound recording and sound reproducing apparatus and instruments, video recording and video producing apparatus and instruments, electronic publications (downloadable), printed matter, printed publications, newspapers, magazines, periodicals, stationery, calendars, diaries, books, greeting cards, post cards, art prints, works of art, catalogues, pictures, newsletters and instructional and teaching materials; online information services, namely, providing information containing curated and original text, audio content, images, photographs and video content in the field of careers via a web site.

- Class 38. Broadcasting services; broadcasting and transmission of text, messages, information, sound and images; transmission of radio and television programmes, text, messages, information, sound and images via communication and computer networks; computer aided transmission of information, messages, text, sound, images, data and radio and television programmes; broadcasting and transmission of digital information by means of cable, wire or fibre; receiving and exchanging of information, text, messages, sound, images and data; electronic mail services; news

information and news agency services; message sending; gateway services for access to a communications or computer network; retrieval, provision and display of information from a computer stored databank; electronic display of information, messages, text, images and data; information, advisory and consultancy services in relation to the aforesaid services.

Class 41. Electronic publication; electronic publication of texts and printed matter, other than publicity texts, on the Internet; electronic publication services; publication and editing of printed matter; publication of printed matter in electronic form; publication services; newspaper publishing; newspaper publication; online publication of electronic newspapers; publication of newspapers, periodicals, catalogs and brochures; publication of newspapers; multimedia publishing of magazines, journals and newspapers; news programming services for transmission across the Internet; news reporter services; news reporting; provision of news relating to sport; news reporting services; provision of entertainment via podcast; entertainment; provision of entertainment information by electronic means; digital video, audio and multimedia entertainment publishing services; organisation of entertainment and cultural events; entertainment services in the nature of arranging social entertainment events; organising competitions; arranging and conducting award ceremonies; online information services, namely,

providing information containing curated and original text, audio content, images, photographs and video content in the field of news, sport, current affairs, culture, the media, entertainment, lifestyle, books, and the arts via a web site.

Class 42. Design and development of software, including applications for the benefit of social media; designing websites for third parties; programming software for internet platforms; hosting platforms on the internet; graphic design.

Mediahuis NV, Katwilgweg 2, 2050 Antwerpen, Belgium. Address for service is c/o MACLACHLAN & DONALDSON, Unit 10, 4075 Kingswood Road, Citywest Business Campus, Dublin 24 D24 C56E, Ireland.

The mark in use is/will be in the colour(s) orange, red and grey

RCYC Gin

RCYC Whiskey

Application is for a Series of 2 Trade Marks.

262497 20 December 2019

Class 33. Spirits.

Stephen King, 9 Tramway Tce, Douglas, Cork T12YP23, Ireland. Address for service is c/o Stephen King, 9 Tramway Tce, Douglas, Cork T12YP23, Ireland.

UNISTOP**Unistop**

Application is for a Series of 2 Trade Marks.

262498 09 January 2020

Class 5. Pharmaceuticals and medical preparations; medicinal and pharmaceutical preparations and substances for use in the treatment of coughs; cough syrups; cough medicine; Dietetic food and substances adapted for medical or veterinary use; food for babies; food supplements; dietary supplements; vitamins and vitamin preparations.

Phoenix Labs Unlimited Company, Suite 12 Bunkilla Plaza, Bracetown Business Park, Clonee, County Meath, Ireland. Address for service is c/o FRKelly, 27 Clyde Road, Ballsbridge, Dublin 4, Ireland.

King Sail Rum**King Sail Gin**

Application is for a Series of 2 Trade Marks.

262499 30 December 2019

Class 33. Spirits.

Stephen King, 9 Tramway Terrace, Douglas East, Douglas, Cork T12 YP23, Ireland. Address for service is c/o Stephen King, 9 Tramway Terrace, Douglas East, Douglas, Cork T12 YP23, Ireland.



262500 23 December 2019

Class 29. Meat; Pork; Beef; Beef fat; Dried beef; Beef slices; Roast beef; Beef jerky; Corned beef; Beef meatballs; Beef steaks; Pulled beef; Beef stew; Prepared beef; Beef bouillon; Roast pork; Pulled pork; Pork steaks; Pork loin; Pork preserves; Pork cutlets; Pork rinds; Sausages; Uncooked sausages; Ham; Hamburgers; Ham hocks; Lamb products; Processed lamb; Lamb skewers; Roast lamb.

Derek Allen, Castlemine, Four Mile House, Co. Roscommon, Ireland. Address for service is c/o Derek Allen, Castlemine, Four Mile House, Co. Roscommon, Ireland.

The mark in use is/will be in the colours black, white, gold, green, yellow



Application is for a Series of 2 Trade Marks.

262501 28 December 2019

Class 20. Medicine trays; Containers for dispensing medication; Pill trays; Parts and fittings for use in all the aforesaid goods.

Niall Barnwell, 9 Drynam Close, Kinsealy, Co. Dublin K67 C588, Ireland. Address for service is c/o William Egan, William Egan & Associates, 1 Malt House Square, Bow Street, Smithfield, Dublin 7, Ireland.



262502 10 January 2020

Class 9. VPN [virtual private network] operating software; Downloadable computer software applications; Smartphone software applications, downloadable.

Class 38. Communication via virtual private networks; Providing virtual private network (VPN) services.

Free Connected Limited, Room 1501, Grand Millennium Plaza (Lower Block), 181 Queen's Road Central, Hong Kong, China. Address for service is c/o Marie Walsh, Garryard House, 26 Earlsfort Terrace, Dublin 2 D02 PX51, Ireland.

The mark in use is/will be in the colour(s) Pantone #2CC9C9, #2DB3C9 & #1199AD



Application is for a Series of 2 Trade Marks.

262503 28 December 2019

Class 20. Medicine trays; Pill trays; Tablet trays; Containers for dispensing medications; Parts and fittings for all the aforesaid goods.

Niall Barnwell, 9 Drynam Close, Drynam Hall, Kinsealy, Co. Dublin K67 C588, Ireland. Address for service is c/o William Egan, William Egan & Associates, 1 Malt House Square, Bow Street, Smithfield, Dublin 7, Ireland.



262504 19 December 2019

Class 9. Phone power bank rental station.

Xpress Charge, 15 Larkfield Close, Clayfarm, Sandyford, Dublin D18W5R2, Ireland. Address for service is c/o Xpress Charge, 15 Larkfield Close, Clayfarm, Sandyford, Dublin D18W5R2, Ireland.

The mark in use is/will be in the colours green, black and white



262505 11 January 2020

Class 21. All-purpose portable household containers; Appliances for removing make-up, non-electric; Applicator sticks for applying makeup; Applicator sticks for applying make-up; Applicators for applying eye make-up; Applicators for cosmetics; Barbecue tongs; Barbecue forks; Baking utensils; Baskets for household purposes; Bath brushes; Bath sponges; Biodegradable cups; Biodegradable bowls; Biodegradable bottles;

Biobased bottles;
 Biodegradable paper pulp-based bowls; Biodegradable paper pulp-based cups;
 Biodegradable paper pulp-based plates; Biodegradable trays; Biodegradable plates;
 Biodegradable trays for domestic purposes; Bottle openers, electric and non-electric; Boxes for dispensing paper towels; Boxes for dispensing paper serviettes; Boxes for holding artificial teeth; Brushes for household purposes; Brushes for personal hygiene; Cardboard cups; Cases for toiletry articles; Cocktail picks; Cocktail sticks; Coffee cups; Combined lids for kitchen containers; Combs;
 Compostable plates; Compostable cups; Compostable bowls; Compost containers for household use; Cookware; Cosmetic brushes; Cosmetic sponges; Cosmetic utensils; Cosmetics applicators; Dental cleaning articles; Dental floss; Dental floss dispensers; Dental floss (floss for dental purposes); Dental floss [floss for dental purposes]; Dental picks for personal use; Dental sticks for personal use; Dental tape; Denture baths; Denture brushes; Deodorising apparatus for personal use; Deodorizing apparatus for personal use; Dinnerware; Dish cloths; Dispensers for cosmetics; Dispensers for detergents; Dispensers for liquid soap; Dispensers for liquid soap [for household purposes]; Dispensers for liquids for use with bottles; Dispensers for paper hand towels; Dispensers for toilet paper; Disposable table plates; Disposable paperboard bakeware; Disposable lids for household containers; Drinking flasks for travellers;

Drinking flasks; Drinking flasks [for travellers]; Drinking straw dispensers; Drinking straws; Drinks containers; Empty water bottles for bicycles; Exfoliating pads; Exfoliating brushes; Exfoliating mitts; Eye make-up applicators; Eyebrow brushes; Travel mugs; Flasks for travellers; Flasks for travellers (Drinking -); Toothpicks; Toothbrushes; Tooth brushes; Toothpick holders; Toothbrush containers; Toothbrush cases; Toothpaste squeezers; Toothpaste dispensers; Flavored toothpicks; Toothbrush holders; Toothbrush bristles; Manual toothbrushes; Electric toothbrushes; Tooth brush cases; Toothpicks of wood; Holders for toothbrushes; Toothbrushes for pets; Oral care kits comprising toothbrushes and floss; Toiletry cases; Comb cases; Toiletry cases [fitted]; Vanity cases (Fitted -).

OCM Eco Health Limited, John O'Connor, Hermitage Court, Dublin Road, Tuam, Ireland. Address for service is c/o OCM Eco Health Limited, John O'Connor, Hermitage Court, Dublin Road, Tuam, Ireland.

The mark in use is/will be in the colour(s) No



262506 09 January 2020

Class 29. Poultry

POULTRY PARTNERS HOLDING N.V.,
Zeisterweg 59, Woudenberg, 3931 ME, The
Netherlands. Address for service is c/o POULTRY
PARTNERS HOLDING N.V., Zeisterweg 59,
Woudenberg, 3931 ME, The Netherlands.

The mark in use is/will be in the colours: shades of
green, blue, white and black



262507 11 December 2019

Class 37. Building construction.

Sean Leahy, Upper Aghada, Midleton, Midleton
P25N129, Ireland. Address for service is c/o Sean
Leahy, Upper Aghada, Midleton, Midleton P25N129,
Ireland.

The mark in use is/will be in the colour(s) Navy and
silver

DUBLIN UNIVERSITY PRESS

Dublin University Press

Application is for a Series of 2 Trade Marks.

262508 18 June 2019

Class 16. Printed matter; newspapers;
magazines; periodicals;
printed publications; books;
stationery; writing
instruments; manuals;
instructional and teaching
materials (except apparatus).

Class 41. Publication of newspapers,
periodicals, magazines and
books in printed or electronic
form; electronic bulletin board
information services relating
to education, training,
entertainment, sport,
recreation and related matters;
on-line information services
relating to education, training,
entertainment, sport,
recreation and related matters;
education; providing of
training; organisation of
competitions (education, sport
or entertainment);
organisation of exhibitions for
educational or cultural
purposes; production of radio
and television programmes.

THE PROVOST, FELLOWS, FOUNDATION
SCHOLARS, AND THE OTHER MEMBERS OF
BOARD OF THE COLLEGE OF THE HOLY AND
UNDIVIDED TRINITY OF QUEEN ELIZABETH
NEAR DUBLIN, College Green, Dublin 2, Ireland.
Address for service is c/o MACLACHLAN &
DONALDSON, Unit 10, 4075 Kingswood Road,
Citywest Business Campus, Dublin 24 D24 C56E,
Ireland.



262509 12 June 2019

- Class 18. Blankets, rugs and coats in this class for animals; clothing for animals; collars for animals; faeces pouches (bags); faeces collection bags for dogs and horses (animal clothing); leads for animals; carrying bags for animals; animal clothing namely faeces pouches (bags); faeces collection bags for dogs and horses.
- Class 20. Kennels; animal housing; pet beds; carriers for transporting domestic pets (other than cages); feeding mats for domestic pets; hutches for pets; nesting boxes for household pets; materials for use as beds for domestic pets; pet cushions.
- Class 21. Pet grooming products, namely brushes and combs; cages for household pets; pet food containers; electronic pet feeders; food bowls for pets; litter boxes (trays) for pets; litter scoops for use with pet animals; litter trays for pets; plastic containers for dispensing drink to pets; plastic containers for dispensing food to pets; wire cages for household pets.
- Class 28. Pet toys and playthings.

Sandleford Holdings Pty Ltd, Building C, 1-19 Industrial Dr, BRAESIDE VIC 3195, Australia. Address for service is c/o FRKelly, 27 Clyde Road, Ballsbridge, Dublin 4, Ireland.

HENSHIN

262510 08 January 2020

- Class 3. Hairspray; Hair colouring; Make-up.
- Class 11. Hairdryers.
- Class 21. Hairbrushes.
- Class 26. Hairpieces.
- Class 44. Salons (Beauty -); Beauty salons; Beauty treatment; Hairdressing; Hair styling; Hair cutting.

Gareth Bromell, 32 Ceaderwood Grove, Castleconnell, Limerick, Ireland. Address for service is c/o Gareth Bromell, 32 Ceaderwood Grove, Castleconnell, Limerick, Ireland.

The mark in use is/will be in the colours black.

THE BRAND PARTNERS AT VALEO FOODS

262511 02 October 2019

- Class 35. Advertising services; Marketing services; Promotional services; Trade promotional services; Promotional marketing;

- Developing promotional campaigns for business; Distribution of advertising, marketing and promotional materials; Demonstration (for promotional/advertising purposes); Business assistance, management and administrative services; Office functions; Financial marketing; Product marketing; Affiliate marketing; Digital marketing; Online marketing; Marketing analysis; Marketing forecasting; Business management; Business risk management services; Business process management; Business accounts management; Business project management services; Business management of wholesale and retail outlets; Corporate communications services; Advertising and marketing services provided via communications channels; Presentation of goods on communications media, for retail purposes; Public relations; Consultancy regarding public relations communications strategy; Prize draws (Organising of -) for promotional purposes; Business management advisory services relating to brand management; Information, consultancy and advisory services in relation to the aforesaid.
- Class 39. Distribution services; Delivery [distribution] of goods; Distribution [transport] of retail goods; Computerised distribution advisory services relating to transport; Distribution services relating to beverages, such as alcoholic beverages; Temporary storage of deliveries; Transportation services; Food Transportation services; Transportation logistics; Arrangement of transportation; Freight transportation services; Import and export cargo handling services; Food delivery services; Packaging and storage of goods; Information, consultancy and advisory services in relation to the aforesaid.
- Class 42. Creation and maintenance of a website.
- Valeo Foods, Commercial House, Millbank Business Park, Lucan, Ireland. Address for service is c/o William Fry, 2 Grand Canal Square, Dublin 2 D02 A342, Ireland.
- The application for registration is proceeding with the consent of the proprietors of EUTM No. 012770831.
-
- 
- 262512** 02 October 2019
- Class 35. Advertising services; Marketing services; Promotional services; Trade promotional services; Promotional marketing; Developing promotional campaigns for business; Distribution of advertising, marketing and promotional materials; Demonstration (for promotional/advertising purposes); Business assistance, management and administrative services; Office functions; Financial marketing; Product marketing;

Affiliate marketing; Digital marketing; Online marketing; Marketing analysis; Marketing forecasting; Business management; Business risk management services; Business process management; Business accounts management; Business project management services; Business management of wholesale and retail outlets; Corporate communications services; Advertising and marketing services provided via communications channels; Presentation of goods on communications media, for retail purposes; Public relations; Consultancy regarding public relations communications strategy; Prize draws (Organising of -) for promotional purposes; Business management advisory services relating to brand management; Information, consultancy and advisory services in relation to the aforesaid.

Class 39. Distribution services; Delivery [distribution] of goods; Distribution [transport] of retail goods; Computerised distribution advisory services relating to transport; Distribution services relating to beverages, such as alcoholic beverages; Temporary storage of deliveries; Transportation services; Food Transportation services; Transportation logistics; Arrangement of transportation; Freight transportation services; Import and export cargo handling services; Food delivery services; Packaging and storage of goods; Information, consultancy and advisory services in relation to the aforesaid.

Class 42. Creation and maintenance of a website.

Valeo Foods, Commercial House, Millbank Business Park, Lucan, Co. Dublin, Ireland. Address for service is c/o William Fry, 2 Grand Canal Square, Dublin 2 D02 A342, Ireland.

The application for registration is proceeding with the consent of the proprietors of EUTM No. 012770831.

The Mile Freshers Pub Golf

262513 12 January 2020

Class 41. Nightclub services; Nightclub services [entertainment]; Entertainment services provided at nightclubs.

GPD Tours Ltd., PO Box 124, Banbridge, BT32 9BA, United Kingdom. Address for service is c/o GPD Tours Ltd., PO Box 124, Banbridge, BT32 9BA, United Kingdom.

The Executive Code

262514 13 January 2020

Class 35. Business consulting; Business management consulting; Business organisation consulting; Business organization consulting; Professional business consulting; Business consulting services; Business consulting for enterprises;

Class 41.	<p>Business management consulting services; Business management and consulting; Business organization and management consulting; Business management and consulting services; Business organisation and management consulting; Business organisation and management consulting services; Consulting services in business organization and management; Management consulting; Personnel management consulting; Business process management and consulting; Business management consultancy in the field of executive and leadership development.</p> <p>Training; Training courses; Providing training; Practical training; Employment training; Training services; Adult training; Personnel training; Business training; Vocational training; Training consultancy; Continuous training; Advanced training; Coaching [training]; Training and further training consultancy; Conducting workshops [training]; Personal training services; Provision of training; Providing of training; Training (Practical -) [demonstration]; Vocational skills training; Vocational training services; Sales training services; Personal development training; Conducting training seminars; Life coaching (training); Staff training services; Management training services; Written training courses; Education and training; Business training services; Training and instruction; Residential training courses; Organisation of training; Personal coaching [training]; Practical training [demonstration]; Publication</p>	<p>of training manuals; Business training consultancy services; Workshops for training purposes; Provision of training courses; Providing courses of training; Training courses (Provision of -); Training relating to sales; Education, teaching and training; Production of training videos; Training in business skills; Training in business management; Organisation of training seminars; Organising of business training; Management training consultancy services; Sales personnel training services; Training services for personnel; Educational and training services; Training and education services; Education and training services; Organisation of training courses; Training of financial personnel; Health and wellness training; Instructional and training services; Provision of online training; Education and training consultancy; Arranging of training courses; Providing online training seminars; Business mentoring services; Coaching; Coaching services.</p> <p>Paul Davis, Minley House, Newtownpark Avenue, Blackrock, Co. Dublin A94 F9P7, Ireland. Address for service is c/o Paul Davis, Minley House, Newtownpark Avenue, Blackrock, Co. Dublin A94 F9P7, Ireland.</p>
-----------	--	--



262515 13 January 2020

- Class 37. Installation and maintenance of automated teller machines.
Class 39. Cash replenishment of automated teller machines.

Brink's Network, Incorporated, 1801 Bayberry Court, Richmond, Virginia 23226, United States of America. Address for service is c/o FRKelly, 27 Clyde Road, Ballsbridge, Dublin 4, Ireland.

The mark in use is/will be in the colour(s) Pantone 286 C and Pantone 304 C

MEDISOOTHE

262516 03 January 2020

- Class 5. Pharmaceuticals, medical and veterinary preparations; Medicine; Sanitary preparations for medical purposes; Dietetic food and substances adapted for medical or veterinary use, food for babies; Dietary supplements for human beings and animals; Plasters,

materials for dressings; Material for stopping teeth, dental wax; Disinfectants; Preparations for destroying vermin; Fungicides, herbicides.

STADA Arzneimittel AG, Stadastraße 2 - 18, 61118 Bad Vilbel, Germany. Address for service is c/o TOMKINS & CO., 5 Dartmouth Road, Dublin 6, Ireland.

EQceed

262517 07 January 2020

- Class 5. Veterinary preparations; Veterinary preparations and substances; Lotions for veterinary purposes; Dog lotions for veterinary purposes; Food supplements for veterinary use; Nutritional supplements for veterinary use; Fodder supplements for veterinary purposes; Feed supplements for veterinary use; Amino acids for veterinary purposes; Probiotic bacterial formulations for veterinary use; Amino acid preparations for veterinary use; Dietetic food adapted for veterinary use; Dietetic substances adapted for veterinary use; Lotions for veterinary purposes; Amino acids for veterinary purposes.

Donal Duggan, Holycross, Thurles, Co Tipperary E41A093, Ireland. Address for service is c/o Donal Duggan, Holycross, Thurles, Co Tipperary E41A093, Ireland.

MAGIC MINCE

262518 13 June 2019

Class 29. Meat substitutes; dairy substitutes; egg substitutes; vegetable-based cream; spreads made of meat substitutes; vegetable or soy based meat substitutes; preserved, frozen, dried and cooked vegetables; formed textured fruit and vegetable protein for use as a meat substitute; formed textured vegetable protein for use as a meat substitute.

De Korte Weg B.V., Jagerskade 17, 3552, TL, Utrecht, The Netherlands. Address for service is c/o FRKelly, 27 Clyde Road, Ballsbridge, Dublin 4, Ireland.

UNBELIEVABALLS

262519 13 June 2019

Class 29. Meat substitutes; dairy substitutes; egg substitutes; vegetable-based cream; spreads made of meat substitutes; vegetable or soy based meat substitutes; preserved, frozen, dried and cooked vegetables, formed textured fruit and vegetable protein for use as a meat substitute; formed textured vegetable protein for use as a meat substitute.

De Korte Weg B.V., Jagerskade 17, 3552, TL, Utrecht, The Netherlands. Address for service is c/o FRKelly, 27 Clyde Road, Ballsbridge, Dublin 4, Ireland.

Opposition(s) under Section 43 of the 1996 Act

- 258475** OXYGENERATION CLINICS LIMITED. Application withdrawn 13 February 2020
- 261231** Glanbel IMP & EXP Limited. Application deemed withdrawn 06 February 2020
- 261281** David McHugh. Application deemed withdrawn 10 February 2020

Application(s) Amended after Advertisement under the 1996 Act

Any person who desires to oppose the registration of these trade marks may within three months from the date of this Journal give notice to the Controller, in accordance with the provisions of Rule 18.

- 261811** Advertised in Journal No: 2398 on 13/11/2019. Specification of goods amended to read: Cl. 5. Food supplements and dietary supplements for humans; all the aforesaid goods, not in relation to veterinary or human ophthalmology.
- 262386** Advertised in Journal No: 2405 on 19/02/2020. Specification of goods amended to read: Cl. 1. Chemicals used in agriculture, horticulture and forestry; chemicals for use in the manufacture of insecticides; chemical additives to insecticides; solvents for use in the manufacture of insecticides; chemicals for use in insecticides. Cl. 5. Preparations

for destroying vermin; fungicides, herbicides; all the aforementioned products only for non-human use.

Application(s) Withdrawn after Advertisement under the 1996 Act

260667 Shalom Oyenuga

Application(s) deemed to be Withdrawn under Section 45(2) of the 1996 Act

260984 Jennifer O'Sullivan
260996 Maurice O'Connell
260997 Jackson L Baker
260999 Maurice O'Connell
261012 Darren Considine
261037 John Stewart
261047 Lee Kenny
261056 John Ryan
261066 Katie Clinton
261077 Dearbhla O'Sullivan

Trade Marks Registered under the 1996 Act

257632 (2344) Cl. 33. Martel Global Wines Limited
260588 (2383) Cl. 41 43. NolaClan Limited
261297 (2391) Cl. 9 35 38 41 42 45. Dantir Dilela Limited
261367 (2392) Cl. 39 41. Francis O'Donnell
261452 (2394) Cl. 41. THEBODYCONTENT
261459 (2394) Cl. 10. Ostoform Limited
261460 (2394) Cl. 16 41 44. Avril Flynn
261465 (2394) Cl. 9 16 36. Allied Irish Banks PLC
261475 (2394) Cl. 41. Adrian Geissel
261505 (2394) Cl. 36. CKM Interactive Solutions Limited
261506 (2394) Cl. 43. Arkle Limited
261533 (2394) Cl. 4 9 11 35 37 39 40 42. Electricity Supply Board
261539 (2394) Cl. 5. Mervue Laboratories Ltd.
261542 (2394) Cl. 30. Rory Moses McKeown
261548 (2394) Cl. 40 43. Izzeddeen Alkarajeh
261555 (2394) Cl. 43. Emanuel Dorofte
261565 (2395) Cl. 29. Dale Farm Limited

261574 (2395) Cl. 29 30. Moy Park Limited
261577 (2395) Cl. 35. EXPLORE INISHOWEN CLG
261583 (2395) Cl. 36 37. Joseph Wade Developments Limited
261594 (2395) Cl. 35 41. Mr. P. Kelly
261600 (2395) Cl. 19. EJ Ireland Access Solutions Limited
261623 (2395) Cl. 9. John Stanley
261631 (2395) Cl. 9 16 35 36 38 41 42 45. Channel Four Television Corporation
261646 (2396) Cl. 9 39. Caroline Allen
261652 (2396) Cl. 30. ABF Grain Products Limited
261661 (2396) Cl. 35 36 37 42. MRP LAND Limited
261674 (2396) Cl. 44. B.R.
261689 (2396) Cl. 29. Nomad Foods Europe IpcO Limited
261692 (2396) Cl. 30. Dale Farm Limited
261713 (2396) Cl. 21. Stafford-Miller (Ireland) Limited
261715 (2396) Cl. 35. Krishan Kant
261716 (2397) Cl. 28 41. State of Illinois, Department of the Lottery
261717 (2397) Cl. 5 31 40 42 44. Regeneron Pharmaceuticals, Inc.
261719 (2397) Cl. 30. CADBURY UK LIMITED
261724 (2397) Cl. 9 16 28 41. Minister for Public Expenditure & Reform
261727 (2397) Cl. 34. American-Cigarette Company (Overseas) Limited
261728 (2397) Cl. 43. Pixie Garden Limited
261729 (2397) Cl. 35 36. Consultas Financial Services
261730 (2397) Cl. 9 41. David O'Shea
261731 (2397) Cl. 30. CADBURY UK LIMITED
261734 (2397) Cl. 41. ATGI APPROVED TOURIST GUIDES OF IRELAND
261735 (2397) Cl. 5 10 40 41 42. Mallinckrodt Pharmaceuticals Ireland Limited
261738 (2397) Cl. 29 30. Knorr-Nahrungsmittel Aktiengesellschaft
261740 (2397) Cl. 29. Lynn's Country Foods Limited
261741 (2397) Cl. 30. INTERCONTINENTAL GREAT BRANDS LLC
261743 (2397) Cl. 33. Aldi Stores (Ireland) Limited
261744 (2397) Cl. 3 44. CONOR MCALLISTER
261745 (2397) Cl. 16 41. John Sisk & Sons (Holdings) Limited
261746 (2397) Cl. 16 41. John Sisk & Sons (Holdings) Limited

261748	(2397) Cl. 29. Lynn's Country Foods Limited	261803	(2397) Cl. 35 44. Centric Health Dental Partnership
261749	(2397) Cl. 29. Lynn's Country Foods Limited	261804	(2397) Cl. 10 12. Meditec Medical Ltd
261750	(2397) Cl. 29. Lynn's Country Foods Limited	261805	(2397) Cl. 5. Sanofi-Aventis Deutschland GmbH
261751	(2397) Cl. 29. Lynn's Country Foods Limited	Renewal of Registrations Under Section 48 of the 1996 Act	
261756	(2397) Cl. 9 44. Intervet International B.V.	31550	Cl. 33. DAVIDE CAMPARI-MILANO S.P.A.
261758	(2397) Cl. 22 25 42. Cairenn Foy	31753	Cl. 12. General Motors LLC
261762	(2397) Cl. 33 35 39. Vinitrading Limited	31754	Cl. 12. General Motors LLC
261763	(2397) Cl. 16 35 43. KW Shelbourne Ops Limited	31846	Cl. 32. DIAGEO IRELAND
261766	(2397) Cl. 4 7 9 11 35 37 39 40 42. Glanbia Ireland Designated Activity Company	40401	Cl. 23. Cordenka GmbH & Co. KG
261767	(2397) Cl. 35 41. Waterford Institute of Technology	40402	Cl. 24. Cordenka GmbH & Co. KG
261768	(2397) Cl. 35 36 37 38 39 40 41 42. DSG Retail Limited	40403	Cl. 25. Cordenka GmbH & Co. KG
261772	(2397) Cl. 42. 3WestStreet	56436	Cl. 33. DANIEL FINBARR MAHON LEE & TERESA A LEE
261773	(2397) Cl. 1. Sealac Limited	56676	Cl. 5. Johnson & Johnson
261775	(2397) Cl. 41. ECDL Foundation	56948	Cl. 33. CHIVAS HOLDINGS (IP) LIMITED
261777	(2397) Cl. 45. Design In Safety Ltd	56949	Cl. 33. CHIVAS HOLDINGS (IP) LIMITED
261778	(2397) Cl. 3 10 32 44. AALTO HYPERBARIC OXYGEN GLOBAL HOLDING LTD.	58003	Cl. 33. DIAGEO SCOTLAND LIMITED
261779	(2397) Cl. 44. Owen Boyden	60789	Cl. 5. DEGESCH GmbH.
261780	(2397) Cl. 10 44. AALTO HYPERBARIC OXYGEN GLOBAL HOLDING LTD	62619	Cl. 5. GLAXO GROUP LIMITED
261781	(2397) Cl. 29. HILTON FOOD GROUP PLC	68337	Cl. 34. P.J. CARROLL & COMPANY LIMITED
261782	(2397) Cl. 3 10 32 44. AALTO HYPERBARIC OXYGEN GLOBAL HOLDING LTD	68398	Cl. 4. Linde, LLC
261783	(2397) Cl. 41. Retirement Life Limited	69497	Cl. 29, Cl. 32. Dole Asia Holdings Pte. Ltd.
261784	(2397) Cl. 9. BriskHeat Corporation	69521	Cl. 16. Essity Hygiene and Health Aktiebolag
261785	(2397) Cl. 41. Irish Triathlon Association Limited CLG	69776	Cl. 9, Cl. 15. Fender Musical Instruments Corporation
261786	(2397) Cl. 1 3 5 29 30 42 43. Spice O Life Limited	86028	Cl. 5. Fuji Chemical Industries Co., Ltd.
261788	(2397) Cl. 32. Black Tap Properties, LLC	86403	Cl. 30. FERRERO S.p.A.
261789	(2397) Cl. 2 16 35. PPG INDUSTRIES AUSTRALIA PTY LTD	86575	Cl. 1. Allnex Germany GmbH
261791	(2397) Cl. 41. Association of Laparoscopic Surgeons of GB & I	86864	Cl. 30. FERRERO S.p.A.
261792	(2397) Cl. 9 44. Glassesbrands Limited	86869	Cl. 5. BSN Medical GmbH
261794	(2397) Cl. 3 16 35 41 44. Andrey Kozlov	86979	Cl. 2. Clariant Produkte (Deutschland) GmbH
261795	(2397) Cl. 3 5 21. Stafford-Miller (Ireland) Limited	86987	Cl. 1. DSM IP Assets B.V.
261796	(2397) Cl. 39 42. Walmart Apollo, LLC	87419	Cl. 33. DIAGEO BRANDS B.V.
261798	(2397) Cl. 29. De Korte Weg B.V.	87829	Cl. 5. T.J. SMITH & NEPHEW, LIMITED
		90717	Cl. 32. Kro Beer Brands
		94452	Cl. 9. MERCK KGaA
		95222	Cl. 5. Johnson & Johnson
		95264	Cl. 33. WaverleyTBS Ltd
		95609	Cl. 14. SEIKO HOLDINGS KABUSHIKI KAISHA (trading as SEIKO HOLDINGS CORPORATION)

95831	Cl. 7, Cl. 12. POCLAIN MARKETING & SERVICES	156878	Cl. 9. MFP SALES LIMITED
96762	Cl. 1. MERCK KGaA	156985	Cl. 5. Johnson & Johnson Surgical Vision, Inc.
96940	Cl. 16. Shortcake IP Holdings LLC	157263	Cl. 33. Allied Domecq Spirits & Wine Limited
96941	Cl. 28. Shortcake IP Holdings LLC	157335	Cl. 34. FILTRONA INTERNATIONAL LIMITED
97103	Cl. 11. WEBER-STEPHEN PRODUCTS CO.	158370	Cl. 5. Alcon Inc.
98357	Cl. 2. MERCK KGaA	160048	Cl. 16. Essity Hygiene and Health Aktiebolag
99342	Cl. 5. Merck Sharp & Dohme Corp.	160368	Cl. 30. FERRERO oHG mbH.
100165	Cl. 29. H.J. HEINZ FOODS UK LIMITED	161109	Cl. 7. Ernst-Apparatebau GmbH
100166	Cl. 30. H.J. HEINZ FOODS UK LIMITED	161851	Cl. 28. Adidas International Marketing BV
106871	Cl. 33. IRISH DISTILLERS LIMITED	163282	Cl. 9. The DIRECTV Group, Inc
131077	Cl. 19, Cl. 21. SAINT-GOBAIN GLASS BENELUX S.A.	163636	Cl. 28. Adidas International Marketing BV
131108	Cl. 29. S-L Snacks National, LLC	173762	Cl. 9. Oracle America, Inc.
131231	Cl. 5. Sumitomo Chemical Agro Europe SAS	174166	Cl. 16. Bank of Scotland Plc
131833	Cl. 5. FRESENIUS KABI AB	177233	Cl. 33. CONSEJO REGULADOR DE LA DENOMINACION DE ORIGEN RIOJA
131932	Cl. 5. DR. FALK PHARMA GMBH	214625	Cl. 40, Cl. 42. Sam McCauley Chemists Limited
132503	Cl. 28, Cl. 30. FERRERO OHG MBH	216478	Cl. 9, Cl. 16. RADIO TELEFIS EIREANN
132846	Cl. 9. EMERSON ELECTRIC CO.	216665	Cl. 25. CSP PARIS FASHION GROUP
132847	Cl. 9. EMERSON ELECTRIC CO.	216720	Cl. 7. Graco Minnesota Inc.
132865	Cl. 3. HARRIS RESEARCH INC.	216740	Cl. 3, Cl. 9, Cl. 18, Cl. 25. Gianni Versace S.r.l.
133031	Cl. 21. Spontex	216809	Cl. 35. Brendan Connors
133155	Cl. 1. VALIO LTD	216833	Cl. 31. Seamus Byrne T/A Stockblock
134292	Cl. 10. JOHNSON & JOHNSON	216834	Cl. 31. Seamus Byrne T/A Stockblock
134386	Cl. 33. Diageo North America, Inc.	216922	Cl. 25. Vulcabras Azalía - RS, Calçados e Artigos Esportivos S/A
134426	Cl. 19. Marazzi Group S.r.l.	217051	Cl. 42. The Ritz Hotel Limited
134731	Cl. 11. Epta S.p.A.	217079	Cl. 32, Cl. 33, Cl. 41, Cl. 42. GILBEYS OF IRELAND LIMITED
136132	Cl. 5. AGRITECH	217082	Cl. 32. ARTHUR GUINNESS SON & COMPANY (DUBLIN) LIMITED
136984	Cl. 3. LVMH FRAGRANCE BRANDS	217093	Cl. 4. Tedcastles Oil Products Limited
140883	Cl. 30. Irish Pride Fine Foods Unlimited Company	217248	Cl. 2. Akzo Nobel Coatings International B.V.
141958	Cl. 30. DD IP Holder LLC	217281	Cl. 21, Cl. 25. SHISEIDO COMPANY LIMITED
154412	Cl. 1. PURAC BIOCHEM B.V.	217510	Cl. 9. PaySys International, Inc.
154413	Cl. 1. PURAC BIOCHEM B.V.	217520	Cl. 5. ROTTAPHARM LTD.
154414	Cl. 1. PURAC BIOCHEM B.V.	217827	Cl. 3, Cl. 5. Johnson & Johnson
154511	Cl. 19. TOBERMORE CONCRETE PRODUCTS LIMITED	217903	Cl. 12. Daimler AG
154879	Cl. 14, Cl. 16. STAEDTLER Mars GmbH & Co. KG	217906	Cl. 12. Daimler AG
154920	Cl. 14. MOSCHINO S.p.A.	217907	Cl. 12. Daimler AG
155143	Cl. 28. Schleich GmbH	217914	Cl. 17, Cl. 19. Xtratherm Limited
155326	Cl. 33. Allied Domecq Spirits & Wine Limited	218183	Cl. 5, Cl. 31. DSM IP Assets B.V.
155399	Cl. 9, Cl. 16. Speedo Holdings B.V.	218205	Cl. 10. Alcon Inc.
155436	Cl. 30. Burton's Foods Limited	218257	Cl. 5. JOHNSON & JOHNSON
E		218561	Cl. 5. Elanco Tiergesundheit AG
155464	Cl. 27. ALTRO LIMITED		
155571	Cl. 12. Iveco S.p.A.		
155717	Cl. 5. Johnson & Johnson		
156253	Cl. 5. JOHNSON & JOHNSON		
156265	Cl. 25. Giesswein Walkwaren AG		
156728	Cl. 12. Schmitz Cargobull AG		

218667	Cl. 30. SOREMARTEC S.A.	243192	Cl. 5, Cl. 9, Cl. 10. MARK FLEMING
218668	Cl. 30. SOREMARTEC S.A.	243193	Cl. 5, Cl. 10. MARK FLEMING
218701	Cl. 9, Cl. 35, Cl. 36, Cl. 38, Cl. 41. FIRSTSTRAND BANK LIMITED	243224	Cl. 5, Cl. 10. MARK FLEMING
218801	Cl. 1. Merck KGaA	243227	Cl. 5, Cl. 10. MARK FLEMING
218824	Cl. 10. Biosense Webster, Inc.	243231	Cl. 5, Cl. 10. MARK FLEMING
219159	Cl. 5. Dow AgroSciences LLC	243233	Cl. 5, Cl. 10. MARK FLEMING
219169	Cl. 33. CEDC INTERNATIONAL SP. Z O.O	243234	Cl. 5, Cl. 10. MARK FLEMING
219210	Cl. 25. George Dallal	243238	Cl. 43. Accor
219838	Cl. 35. Signum International AG	243244	Cl. 5, Cl. 10. MARK FLEMING
220001	Cl. 1. Merck KGaA	243247	Cl. 5, Cl. 10. MARK FLEMING
220503	Cl. 5, Cl. 10, Cl. 35, Cl. 41, Cl. 42. FRESENIUS KABI AG	243272	Cl. 16, Cl. 30, Cl. 35, Cl. 39. GAO MING
220999	Cl. 12. Daimler AG	243287	Cl. 2. CURUST INDUSTRIES LTD
221110	Cl. 3, Cl. 5, Cl. 16, Cl. 21. JOHNSON & JOHNSON	243301	Cl. 43. EDWARD BOURKE
222223	Cl. 41, Cl. 42. BHFS Two Limited	243314	Cl. 11. MARCO BEVERAGE SYSTEMS LTD
222343	Cl. 1, Cl. 9. Merck KGaA	243338	Cl. 35, Cl. 36, Cl. 39. AN POST
222397	Cl. 25. DAVID DELAHUNTY	243357	Cl. 5, Cl. 10. MARK FLEMING
222688	Cl. 5. McNeil AB	243400	Cl. 2. CURUST INDUSTRIES LTD
222815	Cl. 35, Cl. 38, Cl. 42. InterXion Holding N.V.	243401	Cl. 17, Cl. 19. Xtratherm Limited
223346	Cl. 3, Cl. 4, Cl. 6, Cl. 8, Cl. 9, Cl. 14, Cl. 15, Cl. 16, Cl. 18, Cl. 20, Cl. 21, Cl. 24, Cl. 25, Cl. 28, Cl. 29, Cl. 30, Cl. 34, Cl. 35, Cl. 39, Cl. 41, Cl. 42. DIAGEO IRELAND	243410	Cl. 14. Citizen Tokei Kabushiki Kaisha also trading as Citizen Watch Co., Ltd.
223641	Cl. 5, Cl. 10. ALLERGAN PHARMACEUTICALS INTERNATIONAL LIMITED	243412	Cl. 14. Citizen Tokei Kabushiki Kaisha also trading as Citizen Watch Co., Ltd.
225140	Cl. 35, Cl. 36, Cl. 38. FIRSTSTRAND BANK LIMITED	243418	Cl. 14. Citizen Tokei Kabushiki Kaisha also trading as Citizen Watch Co., Ltd.
225563	Cl. 12. Daimler AG	243419	Cl. 14. Citizen Tokei Kabushiki Kaisha also trading as Citizen Watch Co., Ltd.
226342	Cl. 9. Insight Equity A.P.X., L.P.	243426	Cl. 14. Citizen Tokei Kabushiki Kaisha also trading as Citizen Watch Co., Ltd.
226358	Cl. 5. Ferring B.V.	243434	Cl. 5, Cl. 9, Cl. 10. MARK FLEMING
231424	Cl. 3. DE RIGO S.P.A.	243483	Cl. 9. HYUNDAI CORPORATION
236367	Cl. 16, Cl. 35, Cl. 38, Cl. 42. JARDINE MATHESON (BERMUDA) LIMITED	243485	Cl. 29, Cl. 30, Cl. 43. DD IP HOLDER LLC
242459	Cl. 30. Irish Pride Fine Foods Unlimited Company	243523	Cl. 20. HYUNDAI CORPORATION
242460	Cl. 30. Irish Pride Fine Foods Unlimited Company	243554	Cl. 25. LUKASZ GRABOWICZ
243032	Cl. 29. ALDI STORES (IRELAND) LIMITED	243618	Cl. 2. AKZO NOBEL COATINGS INTERNATIONAL B.V
243033	Cl. 32. ALDI STORES (IRELAND) LIMITED	243858	Cl. 21, Cl. 25. DIAGEO IRELAND
243073	Cl. 44. JOHN DONOHOE	243949	Cl. 5. MARK FLEMING
243077	Cl. 30. UNITED BISCUITS (UK) LIMITED	243950	Cl. 5. MEDA PHARMA GMBH & CO. KG
243139	Cl. 5. GERD PETRIK	244055	Cl. 5. MARK FLEMING
243142	Cl. 16, Cl. 36. ALLIANZ P.L.C.	244187	Cl. 16. HENKEL AG & CO. KGAA
243177	Cl. 16, Cl. 30. UNITED BISCUITS (UK) LIMITED	244337	Cl. 30. PEMBERTON & SEYMOUR LIMITED
243180	Cl. 5, Cl. 10. MARK FLEMING	244358	Cl. 5. MARK FLEMING
243182	Cl. 5, Cl. 10. MARK FLEMING	244880	Cl. 30. CJ CORPORATION
		245892	Cl. 10. Alcon Inc.
		246015	Cl. 11. HYUNDAI CORPORATION
		246045	Cl. 7. HYUNDAI CORPORATION

Application to Alter Trade Mark(s) Registered under the 1996 Act

229067 Classes 5, 10 and 31. Swedencare
Ireland Limited.

The mark in the proposed altered form, is as shown
hereunder:



Any person desiring to oppose the application
must give Notice of opposition to the Controller
in accordance with rule 35(2) of the 1996 Rules
within three months of the date of this Journal
issue.

Trade Marks Restored to the Register under Rule 40 of the 1996 Rules

- 242064** Cl. 43. Beacon Leisure Investments
Limited as General Partner for and on
behalf of Beacon Hotel Partnership.
- 242498** Cl. 41. PAUL BYRNE.
-

International Registrations under the Madrid Protocol seeking protection in the State.

Any person desiring to oppose the conferring of protection in the State to the undermentioned marks may, within three months from the date of this Journal give notice to the Controller, in accordance with the provisions of Rule 18.

It should be noted that under the provisions of Rule 63(2) no extension of the opposition period is allowed for lodging opposition under Rule 18.

It is desirable before lodging formal opposition that a communication should be addressed to the holder affording him an opportunity to withdraw his application for protection of the International Registration in the State. In this way cost of opposition proceedings may be avoided.

WIFO

0547835 23/09/2019

Class 35. Advertising; assistance in running or managing a commercial business as well as assistance in managing the business or commercial activities of an industrial or commercial company, all above-mentioned services with relation to gathering information on and monitoring the world and the Austrian economies, writing expert reports on problems specific to the world and to the Austrian economies as well as drafting expert reports and memoranda.

Class 41. Education and entertainment, publication of printed matter; running a specialised scientific library.

Class 42. Organisation of meetings.

ÖSTERREICHISCHES INSTITUT FÜR
WIRTSCHAFTSFORSCHUNG, Arsenal-Objekt 20,
A-1030 WIEN, Austria

Representative: Dr. Clemens Vintschgau
Rechtsanwalt,
Dominikanerbastei 19, A-1010
Wien, Austria

BIVACIN

0579049 05/12/2019

Class 5. Pharmaceutical products, namely an antibiotic product in veterinary medicine.

Boehringer Ingelheim Vetmedica GmbH, 55218
Ingelheim, Germany

DIAKUR

0619595 05/12/2019

Class 5. Veterinary preparations for treating calf scours.

Class 31. Non-medical food supplements for treating calf scours.

Boehringer Ingelheim Vetmedica GmbH, 55218 Ingelheim, Germany

METALYSE

0663771 06/12/2019

Class 5. Pharmaceutical, veterinary and sanitary preparations.

Boehringer Ingelheim International GmbH, 55218 Ingelheim, Germany



OlainFarm

0688323 12/11/2019

Class 5. Pharmaceutical and veterinary products.

"OLAINFARM" A/S, 5, Rupnicu iela, LV-2114 Olaine, Latvia

Representative: Armands Vjaters, Rupnicu street 5, LV-2114 Olaine, Latvia

nak

0822621 07/03/2019

Class 18. Bags, suitcases and other leather products not included in other classes.

Class 25. Clothing, footwear, belts.

"NAK IPODIMATA ASTERIOS GEORGOUDAS SA", 12 Makenzi King Street, GR-54622 Thessaloniki, zc, Greece

Representative: EMMANOUIL TROULIS, 9A Valaoritou Street, GR-106 71 Athens, Greece

Address for service: Mary White, 8 Holywell Grove, Sea Road, Kilcoole A63 RF85, Ireland

PRESUS

1161828 28/11/2019

Class 7. Machines/mechanical devices for gas preparation, in particular, which work on the basis of liquefied gases/starting media and which are suitable for supplying higher pressures, in particular pumps and pressurisers with corresponding framework; pumps and pressurisers, in particular pumps for conveying liquid gas and booster pumps; pressure regulators and safety fixtures for pressurised gas apparatus, in particular pressure regulators and adjustment components, safety valves, pressure relief valves and non-return valves for apparatus for gas preparation; aerators;

machines/mechanical apparatus for mixing and pressure preparation of gases and liquid gases.

LINDE AKTIENGESELLSCHAFT, Klosterhofstr. 1, 80331 München, Germany

Representative: Alois Reggel, Dr.-Carl-von-Linde-Str. 6-14, 82049 Pullach, Germany

Notings: The request for protection is proceeding with the consent of the Holders of International Registration No. 0663018.

Representative: Baker & McKenzie, 1 rue Paul Baudry, F-75008 Paris, France

Address for service: TOMKINS & CO., 5 Dartmouth Road, Dublin 6, Ireland

CAUDALIE

1281857 08/10/2019

- Class 3. Bleaching preparations and other substances for laundry use; cleaning, polishing, degreasing and abrasive preparations; soaps; perfumery, essential oils, cosmetics, hair lotions; dentifrices.
- Class 5. Pharmaceutical, veterinary and sanitary products for medical purposes; dietetic foodstuffs and substances for medical use, food supplements for human beings; food for babies; plasters, materials for dressings (excluding instruments); material for dental fillings and dental impressions; disinfectants for medical or sanitary use (other than soaps); products for destroying vermin; fungicides, herbicides.
- Class 44. Medical services; veterinary services; health and beauty treatments for human beings or animals; beauty salons.

Tomcat International Limited, 1st Floor 26 Eastcastle Street, London W1W 8DQ, United Kingdom

penco

1429010 05/11/2019

- Class 16. Note books; notepads; drawing rulers; pencils; pencil lead holders; pens; ball-point pens; balls for ball-point pens; crayons; pastels [crayons]; adhesive tape dispensers [office requisites]; pencil cases; pen cases; labels of paper or cardboard; paper-clips; clipboards; document file; desktop organizers; writing cases [stationery]; stationery boxes; stationery; electric staplers for offices; addressing machines; ink ribbons; sealing machines for offices; stamp cancelling machines; drawing instruments; typewriters; typewriters, electric or non-electric; mimeographs; relief duplicators; paper shredders for office use; postage meters for office use; franking machines for office use; rotary duplicators; pastes and other adhesives for stationery or household purposes; electric pencil sharpeners; industrial packaging containers of paper; paper bags for packaging; plastic food storage bags for household use; food wrapping plastic

film for household use;
photographs [printed];
photograph stands.

HIGHTIDE Co., Ltd., 1-8-28, Shirogane, Chuo-ku,
Fukuoka-shi, Fukuoka 8100012, Japan

Representative: OHTSUKI Satoshi, Twin21
MID Tower 25F, 2-1-61,
Shiromi, Chuo-ku, Osaka-shi,
Osaka 540-6125, Japan

FIRE & ICE

1430864 06/12/2018

Class 32. Mineral and aerated waters
and other non-alcoholic
beverages, including energy
drinks; non-alcoholic fruit
juice beverages; fruit juices;
syrops for beverages and other
preparations for making
beverages.

"WINE INTERNATIONAL PROJECT" O.O.O., M.
Eminescu street, 5, MD-2012 Kishinev, Republic of
Moldova

Representative: "Ermakova, Stoliarova &
Partners", Patent Agency,
Shmitovsky proezd, d. 2, str. 2,
RU-123100 Moscow, Russian
Federation

Address for
service: MACLACHLAN &
DONALDSON, Unit 10, 4075
Kingswood Road, Citywest
Business Campus, Dublin 24
D24 C56E, Ireland

THE CUP COMPANY

1441352 25/10/2018

Class 29. Meat; fish; poultry; game;
meat extracts; preserved fruit;
preserved vegetables; frozen
fruits; frozen vegetables; dried
fruits; dried vegetables;
stewed fruit; cooked
vegetables; jellies; jams;
compotes; eggs; milk; dairy
products; edible oils; edible
fats.

Class 30. Coffee; tea; cocoa; coffee
substitutes; rice; tapioca;
sago; flour; cereal
preparations; bread; pastry;
confectionery; edible ices;
sugar; honey; molasses syrup;
yeast; baking powder; salt;
mustard; vinegar; sauces
(condiments); spices; ice to
refresh; all the products
mentioned above except for
pasta and rice, pizza,
tabbouleh.

Class 32. Beers; Water; carbonated
waters; non-alcoholic
beverages; fruit-based
beverages; fruit juices;
preparations for making
beverages.

THE CUP COMPANY bvba, Doornpark 16 C, B-
9120 Beveren, Belgium

Representative: ARWEM FOOD GROUP S.A.,
Route de Ghaster 50, Ovifat
(Waimes), B-4950, Belgium



1448284 09/10/2018

- Class 36. Insurance services; financial affairs; monetary affairs; real estate affairs.
- Class 39. Transport; packaging and storage of merchandise; travel organization.
- Class 44. Medical services; veterinary services; hygienic and beauty care for human beings or animals; agriculture, horticulture and forestry services.
- Class 45. Legal services; security services for the protection of property and individuals; detective agency services; baby sitting; escorting in society (chaperoning), mediation; marriage agency services, dating services; horoscope casting; undertaking services, crematorium services, organization of religious meetings; clothing rental.

Priority Date Claimed: 28 September 2018
Switzerland

Patrick Schur, Eggmattweg 7, CH-4312 Magden,
Switzerland

Address for service: Mason Hayes and Curran, South Bank House, Barrow Street, Dublin 4, Ireland

MULTIFREEZ

1448923 18/09/2019

- Class 1. Combusting preparations [chemical additives to motor fuel]; corrosive preparations; alginates for industrial purposes; anti-knock substances for internal combustion engines; antioxidants for use in manufacture; antifreeze; water-softening preparations; oil dispersants; petroleum dispersants; brake fluid; transmission fluid; transmission oil; synthetic materials for absorbing oil; filtering materials [unprocessed plastics]; filtering materials [chemical substances]; filtering materials [mineral substances]; filtering materials [vegetable substances].

Joint-stock company "Obninskorgsintez", Kievskoe highway, 57, Obninsk, RU-249032 Kaluga region, Russian Federation

Representative: Davidenko Nina, Prospekt Mira, 171, Suite 19, RU-129226 Moscow, Russian Federation

FIRE & ICE

1454129 25/03/2019

- Class 33. Vodka.

"WINE INTERNATIONAL PROJECT" OOO, M. Eminescu street, 5, MD-2012 Kishinev, Republic of Moldova

Representative: "Ermakova, Stoliarova & Partners", Patent Agency, Shmitovaky proezd, d. 2, str. 2, RU-123100 Moscow, Russian Federation

Address for service: MACLACHLAN & DONALDSON, Unit 10, 4075 Kingswood Road, Citywest Business Campus, Dublin 24 D24 C56E, Ireland

consultancy services; personnel, recruitment, human resources and employment services, including by online delivery by a global computer information and communications network including the internet and worldwide web; preparation of business reports; business efficiency expert services; interactive and non-interactive research services, all in relation to personnel, recruitment, human resources and employment services, including such services provided by online delivery via a global computer information and communications network including the internet and worldwide web; business management, business administration and office functions relating to collecting, processing and provision of psychometric and employee data; employment profile services including by way of a global computer information and communications network; exploitation of statistical data for psychometric testing, employee evaluation and human resources functions; data processing for the collection of data for business purposes, including online; compilation of statistics, including business statistics for psychometric testing, employee evaluation and human resources functions; consultancy relating to the preparation of business statistics for psychometric testing, employee evaluation and human resources functions; benchmarking (evaluation of business organisation practices and human resource management); business organisation consulting in

EMOTIFY

1462489 24/01/2019

- Class 9. Application software for psychometric testing, employee evaluation and human resources functions; computer game programs downloaded from a global computer network for psychometric testing, employee evaluation and human resources functions; downloadable computer programmes (programs) for psychometric testing, employee evaluation and human resources functions; interactive computer software namely gamified psychometric testing and employee recruitment tools.
- Class 35. Business management, business administration and office functions relating to the management and operation of interactive and non-interactive online talent acquisition and talent management services; business strategy services; human resource management; employment consultancy services; psychological testing for the selection of personnel; employment recruiting

- relation to talent acquisition and talent management services.
- Class 41. Publishing information regarding personnel, recruitment, human resources and employment services in electronic form via a global computer information and communication network; employment training; educational research; computer based training relating to psychometric testing, employee evaluation and human resources functions; game services provided online for psychometric testing, employee evaluation and human resources functions; interactive and non-interactive vocational guidance and consultancy services, and personal development services, all in relation to personnel, recruitment, human resources and employment services, including such services provided by online delivery via a global computer information and communications network including the internet and worldwide web.
- Class 42. Computer aided employee performance monitoring and analysis services; evaluation of performance against benchmark references; providing information, including online, about scientific and technological services and research and design for psychometric testing, employee evaluation and human resources functions; setting of quality standards for psychometric testing, employee evaluation and human resources functions; computer programmes (programs) and computer software available for use online via the internet for psychometric testing,

- employee evaluation and human resources functions.
- Class 45. Employment screening services; identity verification; provision of background check services.

Priority Date Claimed: 07 August 2018 Australia

Talentcorp Pty Ltd, 21 Windorah St, STAFFORD QLD 4053, Australia

Representative: Swaab, Level 1., 20 Hunter Street, Sydney NSW 2000, Australia

Address for service: FRKelly, 27 Clyde Road, Ballsbridge, Dublin 4, Ireland



1470794 20/12/2018

- Class 32. Aperitifs, non-alcoholic; barley wine [beer]; lithia water; seltzer water; soda water; waters [beverages]; aerated water; mineral water [beverages]; table waters; kvass [non-alcoholic beverage]; cocktails, non-alcoholic; beer-based cocktails; lemonades; non-alcoholic beverages; isotonic beverages; non-alcoholic honey-based beverages; rice-based beverages, other than milk substitutes; soya-based beverages, other than milk substitutes; aloe vera drinks,

non-alcoholic; whey beverages; protein-enriched sports beverages; soft drinks; non-alcoholic beverages flavored with coffee; non-alcoholic beverages flavored with tea; non-alcoholic fruit juice beverages; energy drinks; fruit nectars, non-alcoholic; orgeat; beer; ginger beer; malt beer; powders for effervescing beverages; sarsaparilla [non-alcoholic beverage]; syrups for lemonade; syrups for beverages; smoothies; tomato juice [beverage]; cider, non-alcoholic; vegetable juices [beverages]; fruit juices; preparations for making aerated water; preparations for making liqueurs; preparations for making beverages; must; grape must, unfermented; beer wort; malt wort; pastilles for effervescing beverages; sherbets [beverages]; non-alcoholic fruit extracts; extracts of hops for making beer; essences for making beverages.

Priority Date Claimed: 05 December 2018 Russian Federation

"WINE INTERNATIONAL PROJECT" OOO, M. Eminescu street, 5, MD-2012 Kishinev, Republic of Moldova

Colour Claimed: Black, dark blue, blue, light blue, white, light yellow, yellow, red and brown-red., Half of disk is in white, light blue, blue to dark blue and black colors, another half is in light yellow, yellow, to red and brown-red colors.

Representative: "Ermakova, Stoliarova & Partners", Patent Agency, Shmitovskiy proezd, d. 2, str. 2, RU-123100 Moscow, Russian Federation

Address for service: MACLACHLAN & DONALDSON, Unit 10, 4075 Kingswood Road, Citywest Business Campus, Dublin 24 D24 C56E, Ireland



1473087 25/01/2019

Class 33. Vodka.

Priority Date Claimed: 23 January 2019 Russian Federation

"WINE INTERNATIONAL PROJECT" O.O.O., M. Eminescu street, 5, MD-2012 Kishinev, Republic of Moldova

Colour Claimed: Blue, white, red., Mountains in white and blue, words "FIRE" and "ICE" in blue, symbol "&" in red.

Representative: "Stoliarova & Partners", Patent Agency, Shmitovskiy proezd, d. 2, str. 2, RU-123100 Moscow, Russian Federation

Address for service: MACLACHLAN & DONALDSON, Unit 10, 4075 Kingswood Road, Citywest Business Campus, Dublin 24 D24 C56E, Ireland

Ro**1481338** 20/08/2019

- Class 11. Electric coffee-, tea- and espresso machines; electric coffee- and tea capsule machines; electric water kettles.
- Class 21. Non-electric coffee- and tea machines; non-electric coffee- and tea capsule machines; glass jugs; insulating flasks and -container; drinking vessels.
- Class 30. Cocoa-based beverages; chocolate; sugar.
- Class 32. Non-alcoholic beverages; aerated water; fruit juices.
- Class 35. Retail services in relation to electric coffee-, tea- and espresso machines, electric coffee- and tea capsule machines, electric water kettles, non-electric coffee- and tea machines, non-electric coffee- and tea capsule machines, glass jugs, insulating flasks, containers and drinking vessels for coffee, tea, cacao, chocolate, sugar.
- Class 43. Services for providing food and drink.

10X Innovation GmbH & Co. KG, Mehringdamm 57,
10961 Berlin, Germany

Address for service: TOMKINS & CO., 5 Dartmouth Road, Dublin 6, Ireland

**1482652** 08/03/2019

- Class 35. Incubation services; incubation services, namely, providing office space to emerging, start-up and existing companies; business operation of commercial real estate, offices and office space; business operation of commercial real estate, offices and office space, namely, shared office venues with conference facilities; providing office-share services; providing co-working facilities equipped with private offices, office equipment, mailroom, printing center, receptionist, kitchen, meeting rooms, telecommunications equipment and other office amenities; business information services; providing work space containing business equipment and other amenities to emerging, start-up and existing companies; business development services in the nature of providing start-up support for businesses of others; providing office support staff services; online business networking services; business contract negotiation with providers of insurance, banking, credit card processing, travel and transportation services, to enable participant members of a business community to obtain discounts on the purchase of those services from others; computer assisted business information and research services; assistance and advice regarding business location;

arranging and conducting special events, parties, camps, and concerts for advertising and promotional purposes; job listing services, career placement services, providing on-line employment information in the field of careers, job listings, job resources and resumes; job placement; personnel placement and recruitment; providing on-line employment placement services in the nature of matching resumes and potential employers; providing career information; business networking services; business consultation services in the nature of office space design; business management and organization consultancy; real estate marketing analysis; providing electronic tracking of real estate assets to others for business purposes; planning, maintenance, tracking and reporting of real estate construction projects for third parties for business purposes; providing office support staff services; business project management for others; business consulting services in the fields of spatial layout and infrastructure architecture and interior design; consulting services in the field of spatial management to optimize business process efficiency and decision-making; computer-aided optimization and management, namely, managing logistics and physical spaces; providing convenience store and on-line convenience store services, providing business information for the sales of goods and services of others from an on-line searchable database; providing an on-line searchable ordering guide for locating, organizing and presenting goods and services

of other on-line vendors; retail store services relating to computer hardware, computer software, computer peripherals, information technology equipment, telecommunications equipment, accessories and chargers for computer hardware, computer software, computer peripherals, paper, stationery, printed publications, office requisites, food, beverages; online retail store services relating to computer hardware, computer software, computer peripherals, information technology equipment, telecommunications equipment, accessories and chargers for computer hardware, computer software, computer peripherals, paper, stationery, printed publications, office requisites, food, beverages.

Class 36. Real estate services; real estate services, namely, leasing of real property and apartments; leasing of office space; leasing or renting of buildings; real estate brokerage; rental of office space; rental of temporary and shared office spaces and offices; commercial real estate brokerage; leasing of real estate; real estate services, namely, management, ownership and franchise of condominiums, apartments, office facilities.

Class 37. Real estate construction services, namely, construction of office space and office facilities; building construction; building repair and maintenance; installation services, namely, installation of lighting apparatus, security systems, doors, HVAC (Heating, ventilation and air conditioning), flooring, wiring, machinery, audiovisual equipment,

Class 42.	fixtures and fittings for buildings, and computer hardware and telecommunication apparatus; construction consultancy and supervision; construction project management services. Architectural design; interior design services; design of specialty interior and exterior environment settings; graphic design services; industrial design services; engineering services for building and property condition assessment, facility management, repair and restoration and building instrumentation; information and data analysis relating to planning and laying out design for the interior space and fixtures of buildings and offices; planning of buildings and infrastructure systems for buildings; providing non-downloadable computer software platform for the purposes of monitoring, analyzing and controlling environmental conditions and devices within a building, facility, grounds of designated spatial area and providing information to manage activities in the area; providing non-downloadable computer software platform for the purposes of facilities management to control building environment, access and security systems; non-downloadable computer software platform and software as a service (SAAS) for the purposes of spatial mapping of floor plans and fixtures; non-downloadable computer software platform and software as a service (SAAS) for the purposes of management of spatial information for the purpose of space optimization within a building or other facility; non-downloadable computer	software platform and software as a service (SAAS) for the purposes of visualization, animation and analytics of spatial data; non-downloadable software platform and software as a service (SAAS) that manages a pipeline of real estate deals and assets of others; non-downloadable software platform and software as a service (SAAS) for administering leases, tracking lease negotiations and tracking lease documentation; non-downloadable software platform and software as a service (SAAS) for administering and managing co-working facilities; non-downloadable software platform and software as a service (SAAS) featuring technology enabling users to remotely view, monitor, program, operate and control electrical systems and security systems in offices; planning and layout design services for interior space of business establishments; data mining; planning and layout design services for interior space of business establishments; hosting a website featuring technology enabling users to remotely view, monitor, program, operate and control electrical systems and security systems in offices; planning and layout design services for interior space of business establishments; data mining; providing non-downloadable visitor registration computer software that records entry and exit of visitors and collects visitor information; providing non-downloadable visitor registration computer software that enables preparation and distribution of signed electronic visitor registration documents; providing non-downloadable
-----------	---	--

visitor registration computer software that enables the printing of visitor badges with photos; providing non-downloadable visitor registration computer software that notifies others of the arrival of a visitor; and providing non-downloadable visitor registration computer software that prepares reports of visitors; design and technical planning of real estate construction projects for third parties.

Class 43. Hospitality services, namely, providing food and beverage; providing food and beverage services; providing meeting room space; restaurant and lounge services; providing facilities for business meetings and business events.

Priority Date Claimed: 12 September 2018 Indonesia

Priority Date Claimed: 12 September 2018 Indonesia

Priority Date Claimed: 12 September 2018 Indonesia

Priority Date Claimed: 25 September 2018 Latvia

Priority Date Claimed: 15 November 2018 Norway

WeWork Companies Inc., 115 West 18th Street, New York NY 10011, United States of America

Representative: Nadine H. Jacobson, Esq.
FROSS ZELNICK LEHRMAN
& ZISSU, P.C., 4 Times Square,
17th Floor, New York NY
10036, United States of
America

Address for service: FRKelly, 27 Clyde Road,
Ballsbridge, Dublin 4, Ireland

SIMONE HERMES

1485120 10/07/2019

Class 18. Handbags, rucksacks, traveling bags, briefcases, pocket wallets, purses, card cases (notecases), key cases (leatherware), traveling sets (empty), pouches intended to hold toilet products (empty), pouches (evening handbags), leather pouches.

Priority Date Claimed: 08 March 2019 France

HERMES INTERNATIONAL, 24 rue du Faubourg Saint-Honoré, F-75008 PARIS, France

Representative: Nicolas Martin, HERMES INTERNATIONAL -, 24, rue du Faubourg Saint-Honoré, F-75008 PARIS, France

Address for service: FRKelly, 27 Clyde Road,
Ballsbridge, Dublin 4, Ireland



1486065 23/04/2019

Class 9. Measuring apparatus and instruments; apparatus and instruments for conducting, switching, transforming, accumulating, regulating or controlling electricity; devices for metering electrical power consumption; devices for calculation of electrical power consumption; computer programs; data processing equipment and computers; computer programs, devices and equipment for processing data for calculation of

	<p>electrical power consumption; chips (parts of integrated circuits); holders for electrical coils; electrical devices and installations for remote control of industrial operations; integrated circuits; inverters (electricity); calibrating instruments; contacts (electrical); magnets; measuring devices; measuring tables (measuring instruments); metering devices (meters), microprocessors; modems; anti-interference devices; converters, electrical; connectors, electrical; computer programs and computer software, downloadable from computer network; computer programs, registered; distribution boxes (electricity); branch boxes (electricity), electrical regulating apparatus; automatic time switches; counters (meters); printed circuit boards; sockets, plugs and other contacts.</p>	<p>hardware and software for metering electrical power consumption and for calculation of electrical power consumption; graphic design and industrial design; engineering; calibration [measuring]; chemical analysis; chemical research; chemistry services; quality control; conversion of data or documents from physical to electronic media; conversion of computer programs and data, other than physical conversion; duplication of computer programs; styling (industrial design); computer software design; updating of computer software; material testing; computer system design; computer software design; computer system analysis; computer programming, research and development (for others); mechanical research; computer software consultancy; consultancy in protection of environment; installation of computer software; maintenance of computer software.</p>
Class 38.	<p>Telecommunications; transmission of electronic mail; communications by cellular phones; communications by computer terminals; communications by fiber optic networks; communications by electrical wire network; message sending; computer aided transmission of messages and images; communications by telephone; telecommunications routing and junction services.</p>	<p>Priority Date Claimed: 02 November 2018 Slovenia</p>
Class 42.	<p>Scientific and technological services and research and design relating thereto; industrial analysis and research services; design and development of computer hardware and software; research and development of computer hardware and software; research and development of computer</p>	<p>Iskraemeco d.d., Savska Ioka 4, SI-4000 Kranj, Slovenia</p>
		<p>Colour Claimed: Red, black and white., The initial element of the mark letters "ie" stylized is red, the remaining part of the mark is black, the entire mark is placed on a white background.</p>
		<p>Representative: Mark-Inventa d.o.o., Glinska ulica 14, SI-1000 Ljubljana, Slovenia</p>
		<p>Address for service: FRKelly, 27 Clyde Road, Ballsbridge, Dublin 4, Ireland</p>



1486122 12/03/2019

- Class 7. Machines and machine tools for building and maintaining railways and overhead wires, especially powered machines for cutting rails, machines for bending rails, machines for descaling rails, machines for striking rails, machines for drilling rails, machines for grinding rail, machines for lifting rails, machines for cleaning rails, machines for laying rails, machines for replacing rails, machines for treating the ballast, machines for straightening rails, machines for re-profiling rails, machines for sealing rails, machines for drilling crosspieces, machines for cutting crosspieces, machines for handling crosspieces, machines for laying crosspieces, machines for sawing crosspieces, machines for filling the ballast, machines for screwing and unscrewing the sleeper screws, machines for inserting and removing the sleeper screws, machines for inserting and removing rail fasteners, machines for brushing rail ends, machines for greasing rails, machines for extending rails, rail benders, deburring machines, machines for cleaning the ballast.
- Class 8. Hand-operated tools and instruments for the construction and maintenance of railways, especially pickaxes, shovels, forks, rail clips, rail tensioner, wedging shoes, crowbars, tools and instruments for lifting the rails, tools for inserting and

- removing rail fasteners, wrenches for crutches, hand-operated saws for rails and crosspieces, wicks, reamers, drills, jacks, hand instruments for pulling rails, hand apparatus for securing and tightening the frets, pliers for crosspieces.
- Class 9. Apparatus and instruments for measuring and recording parameters of railways and overhead wires; apparatus and instruments for measuring rail temperature; apparatus and instruments for monitoring wear of rail and overhead wire; devices for the protection of personnel on railways.
- Class 12. Specialized and versatile railway vehicles for construction and maintenance of railways and overhead wires, especially railway inspection vehicles, railway vehicles for transporting personnel and materials, railway vehicles for ballast distribution, railway vehicles for unwinding overhead wires, railway vehicles for ballast tamping, locomotives, railway vehicles for rail works, railway carts, railway handling carts, railway lifting trucks, railway cars for transportation of material, rail trailers for transportation of material, trains for laying and renewing the railway, trains for laying overhead wires, handcars, ballast railway plows, railway vehicles for measuring railways and/or overhead wires, locomotives.
- Class 37. Rental of equipment and tools for the construction and maintenance of railways and overhead wires, especially machines and machine tools for the construction and maintenance of railways and overhead wires, power machines for cutting rails, machines for bending rails,

machines for descaling rails, machines for striking rails, machines for drilling rails, machines for grinding rails, machines for lifting rails, machines for cleaning rails, machines for laying rails, machines for replacing rails, machines for treating the ballast, machines for straightening rails, machines for re-profiling rails, machines for drilling rails, machines for the cutting crosspieces, machines for handling crosspieces, machines for laying crosspieces, machines for sawing crosspieces, machines for filling the ballast, machines for screwing and unscrewing the sleeper screws, machines for inserting and removing the sleeper screws, machines for inserting and removing rail fasteners, machines for brushing rail ends, machines for greasing rails, machines for extending rails, rail benders, deburring machines, machines for cleaning the ballast; rental of hand-operated material, tools and instruments for the construction and maintenance of railways, especially pickaxes, shovels, forks, rail clips, rail tensioner, wedging shoes, crowbars, tools and instruments for lifting the rails, tools for inserting and removing rail fasteners, wrenches for crutches, hand-operated saws for rails and crosspieces, wicks, reamers, drills, jacks, hand instruments for pulling rails, hand apparatus for securing and tightening the frets, pliers for crosspieces, tools and instruments for protecting the personnel on railway; installation, maintenance and repair services for machines, tools and rail vehicles for railways and overhead wires, especially machines and

machine-tools for the construction and maintenance of the railway and overhead wire, powered machines for cutting rails, machines for bending rails, machines for descaling rails, machines for striking rails, machines for drilling rails, machines for grinding rail, machines for lifting rails, machines for cleaning rails, machines for laying rails, machines for replacing rails, machines for treating the ballast, machines for straightening rails, machines for re-profiling rails, machines for sealing rails, machines for drilling crosspieces, machines for cutting crosspieces, machines for handling crosspieces, machines for laying crosspieces, machines for sawing crosspieces, machines for filling the ballast, machines for screwing and unscrewing the sleeper screws, machines for inserting and removing the sleeper screws, machines for inserting and removing rail fasteners, machines for brushing rail ends, machines for greasing rails, machines for extending rails, rail benders, deburring machines, machines for cleaning the ballast; installation, maintenance and repair services for railways and overhead wires, hand-operated tools and instruments for the construction and maintenance of the railway, especially pickaxes, shovels, forks, rail clips, rail tensioner, wedging shoes, crowbars, tools and instruments for lifting the rails, tools for inserting and removing rail fasteners, wrenches for crutches, hand-operated saws for rails and crosspieces, wicks, reamers, drills, jacks, hand instruments for pulling rails, hand apparatus for

securing and tightening the frets, pliers for crosspieces, tools and instruments for protecting the personnel on railway; installation, maintenance and repair of specialized and versatile railway vehicles for construction and maintenance of railways and overhead wires, especially railway inspection vehicles, railway vehicles for transporting personnel and materials, railway vehicles for ballast distribution, railway vehicles for unwinding overhead wires, railway vehicles for ballast tamping, locomotives, railway vehicles for rail works, railway handling carts, railway lifting trucks, railway cars for transportation of material, rail trailers for transportation of material, trains for laying and renewing the railway, trains for laying overhead wires, railway carts, handcars, locomotives, ballast railway plows, railway vehicles for measuring railways and/or overhead wire.

Class 39. Rental of specialized and versatile railway vehicles for construction and maintenance of railways and overhead wires, especially railway inspection vehicles, railway vehicles for transporting personnel and materials, railway vehicles for ballast distribution, railway vehicles for unwinding overhead wires, railway vehicles for ballast tamping, locomotives, railway vehicles for rail works, railway carts, railway handling carts, railway lifting trucks, railway wagons for transportation of material, rail trailers for transportation of material, trains for laying and renewing the railway, trains for laying and renewing the rail, trains for laying overhead

wires, handcars, locomotives, ballast railway plows, railway vehicles for measuring railways and/or overhead wires.

Priority Date Claimed: 18 September 2018
Switzerland

Geismar Gleisbaumaschinen AG, Gewerbestrasse 15,
CH-4123 Allschwil, Switzerland

Representative: CABINET WEINSTEIN, 176
Avenue Charles de Gaulle, F-
92200 NEUILLY-SUR-SEINE,
France

Address for service: Cruickshank, 8A Sandyford
Business Centre, Sandyford,
Dublin 18, Ireland

RIDERS OF THE KNIGHTS

1487463 10/07/2019

Class 14. Precious metals and their alloys; jewelry, jewelry boxes, jewelry cases; jewelry, jewelry boxes, jewelry cases made from precious metals and their alloys or coated therewith; precious and semi-precious stones; pearls; bracelets (jewelry); bracelets (jewelry) made from precious metals and their alloys or coated therewith; brooches (jewelry); brooches (jewelry) made from precious metals and their alloys or coated therewith; necklaces (jewelry); necklaces (jewelry) made from precious metals and their alloys or coated therewith; chains (jewelry); chains (jewelry) made from precious metals and their alloys or coated therewith; medals (jewelry); medals

(jewelry) made from precious metals and their alloys or coated therewith; pendants (jewelry); pendants (jewelry) made from precious metals and their alloys or coated therewith; earrings (jewelry); earrings (jewelry) made from precious metals and their alloys or coated therewith; rings (jewelry); rings (jewelry) made from precious metals and their alloys or coated therewith; tie pins; tie pins made from precious metals and their alloys or coated therewith; cuff links; cuff links made from precious metals and their alloys or coated therewith; key rings; key rings made from precious metals and their alloys or coated therewith; jewelry cases [caskets]; jewelry cases [caskets] made from precious metals and their alloys or coated therewith; boxes of precious metal; boxes made of precious metal alloys or coated therewith.

Priority Date Claimed: 01 February 2019 France

LOUIS VUITTON MALLETIER, 2 rue du Pont-Neuf, F-75001 PARIS, France

Representative: SOCIETE LOUIS VUITTON SERVICES, Madame SOPHIE REGISSER, DIRECTION PROPRIETE INTELLECTUELLE, 2 rue du Pont-Neuf, F-75001 Paris, France

Address for service: TOMKINS & CO., 5 Dartmouth Road, Dublin 6, Ireland

CHIARO Zurich

1487664 10/07/2019

- Class 3. Non-medicated toiletry preparations and cosmetic products; non-medicated dentifrices; perfumery products, essential oils; bleaching preparations and other substances for laundry use; cleaning, polishing, degreasing and abrasive preparations; all the aforesaid goods of Swiss origin.
- Class 4. Industrial oils and greases, waxes; lubricants; dust absorbing, wetting and binding compositions; fuels and lighting fuel; candles and wicks for lighting; all the aforesaid goods are of Swiss origin.
- Class 35. Advertising; commercial business management; commercial administration; office functions; all the services of Swiss origin.
- Class 44. Medical services; veterinary services; hygienic and beauty care for human beings or animals; agriculture, horticulture and forestry services; all the aforesaid services are of Swiss origin.

Priority Date Claimed: 20 March 2019 Switzerland

RGP beauty and cosmetics AG, Talacker 41, CH-8001 Zürich, Switzerland



1489626 07/08/2019

Class 7. Woodworking machines; metalworking machines; machine tools; electric power tools; saws [machines]; circular saws [machines]; hand-held circular saws [machines]; table saws [machines]; jigsaws [machines]; routers [machines]; planing machines; parts of all aforementioned goods as far as included in this class.

Priority Date Claimed: 16 April 2019 Germany

TTS Tooltechnic Systems AG & Co. KG, Wertstraße 20, 73420 Wendlingen, Germany

Notings: The request for protection is proceeding with the consent of the proprietors of Registered European Union Trade Mark No. 001018597.

Representative: Patentanwälte Magenbauer & Kollegen Partnerschaft mbB, Plochinger Straße 109, 73730 Esslingen, Germany

Address for service: TOMKINS & CO., 5 Dartmouth Road, Dublin 6, Ireland

MAKALINI

1493753 26/07/2019

Class 6. Common metals and their alloys, ores; metal materials for building and construction; transportable buildings of metal; non-electric cables and wires of common metal; small items of metal hardware; metal containers for storage or transport; safes; aluminium; fittings of metal for compressed air lines; fittings of metal for building; white metal; beacons of metal, non-luminous; vats of metal; beams of metal; joists of metal; bottles [metal containers] for compressed gas or liquid air; balustrades of metal; tin cans; reels of metal, non-mechanical, for flexible hoses; swimming pools [structures] of metal; beryllium [glucinium]; arbours [structures] of metal; window pulleys; blooms [metallurgy]; ingots of common metal; anchors; bolts of metal; eye bolts; casks of metal; mooring buoys of metal; barrels of metal; identification bracelets of metal; bronze; bells; bells for animals; letters and numerals of common metal, except type; silos of metal; busts of common metal; vanadium; bird baths [structures] of metal; valves of metal, other than parts of machines; screws of metal; aviaries [structures] of metal; tungsten; hoppers of metal, non-mechanical; gates of metal; ferrules of metal for handles; signboards of metal; diving boards of metal; loading gauge rods of metal for railway wagons; nuts of metal; galena [ore]; hafnium [celtium]; nails; crampons [climbing irons]; tacks [nails];

horseshoe nails; shoe pegs of metal; germanium; vice claws of metal; armored doors of metal; doors of metal; folding doors of metal; swing doors of metal; accordion doors of metal; chimney pots of metal; door closers of metal, non-electric; prefabricated houses [kits] of metal; memorial plates of metal; chimney shafts of metal; wall plugs of metal; troughs of metal for mixing mortar; packaging containers of metal; containers of metal for storing acids; jalousies of metal; outdoor blinds of metal; iron, unwrought or semi-wrought; iron strip; roof gutters of metal; street gutters of metal; tinsplate; iron slabs; door bolts of metal; window fasteners of metal; bolts, flat; clips of metal for sealing bags; binding screws of metal for cables; crampons of metal [cramps]; wheel clamps [boots]; rivets of metal; padlocks; box fasteners of metal; locks of metal for bags; locks of metal for vehicles; locks of metal, other than electric; spring locks; closures of metal for containers; bungs of metal; latches of metal; tension links; couplings of metal for chains; road signs, non-luminous and non-mechanical, of metal; registration plates of metal; signs, non-luminous and non-mechanical, of metal; fences of metal; buckles of common metal [hardware]; bronzes [works of art]; works of art of common metal; sleeves [metal hardware]; indium; cabanas of metal; telephone booths of metal; cadmium; paint spraying booths of metal; telpher cables; ropes of metal; jerrycans of metal; traps for wild animals; greenhouse frames of metal; framework of metal for building; cornices of

metal; skating rinks [structures] of metal; cermets; water-pipe valves of metal; drain traps [valves] of metal; metal cages for wild animals; keys of metal; mooring bollards of metal; cobalt, raw; chill-molds [foundry]; elbows of metal for pipes; bed casters of metal; furniture casters of metal; manifolds of metal for pipelines; door bells of metal, non-electric; casings of metal for oilwells; pillars of metal for building; chimney cowls of metal; bottle caps of metal; sealing caps of metal; tent pegs of metal; copper rings; ferrules of metal; split rings of common metal for keys; rings of metal; door fittings of metal; fittings of metal for windows; brackets of metal for building; buildings of metal; buildings, transportable, of metal; steel buildings; oil drainage containers of metal; containers of metal [storage, transport]; guard rails of metal for railways; baskets of metal; door frames of metal; tool boxes of metal, empty; stringers [parts of staircases] of metal; taps of metal for casks; tubing of metal; brackets of metal for furniture; roofing of metal; roofing of metal, incorporating photovoltaic cells; turntables [railways]; screw tops of metal for bottles; manhole covers of metal; hooks [metal hardware]; pitons of metal; pot hooks of metal; hooks of metal for roofing slates; sash fasteners of metal for windows; hooks of metal for clothes rails; bag hangers of metal; clothes hooks of metal; chicken-houses of metal; chests of metal; brass, unwrought or semi-wrought; wrapping or binding bands of metal; scaffolding of metal;

staircases of metal; ladders of metal; limonite; steel sheets; cast steel; magnesium; manganese; reinforcing materials, of metal, for concrete; reinforcing materials of metal for machine belts; reinforcing materials of metal for pipes; reinforcing materials of metal for building; railway material of metal; materials of metal for funicular railway permanent ways; refractory construction materials of metal; masts of metal; steel masts; copper, unwrought or semi-wrought; sheets and plates of metal; common metals, unwrought or semi-wrought; pyrophoric metals; metals in powder form; mouldings of metal for building; moldings of metal for cornices; molybdenum; door knockers of metal; pipe muffs of metal; shoe dowels of metal; porches [structures] of metal; monuments of bronze for tombs; tombs of metal; flashing of metal for building; roof flashing of metal; fish plates [rails]; anvils; anvils [portable]; beak-irons; rope thimbles of metal; ferrules of metal for walking sticks; handcuffs; jets of metal; duckboards of metal; belt stretchers of metal; stretchers for metal bands [tension links]; wire stretchers [tension links]; stretchers for iron bands [tension links]; nickel silver; nickel; niobium; grease nipples; binding thread of metal for agricultural purposes; thread of metal for tying-up purposes; house numbers of metal, non-luminous; braces of metal for handling loads; wall claddings of metal for building; enclosures of metal for tombs; laths of metal; barrel hoops of metal; wall linings of metal for building; palings of metal; crash barriers of metal for

roads; furnace fireguards of metal; tree protectors of metal; latticework of metal; door stops of metal; stops of metal; window stops of metal; windows of metal; ironwork for doors; ironwork for windows; tin; shuttering of metal for concrete; filings of metal; poles of metal for power lines; props of metal; branching pipes of metal; monuments of metal; monuments of metal for tombs; metal ramps for use with vehicles; wainscotting of metal; signalling panels, non-luminous and non-mechanical, of metal; building panels of metal; partitions of metal; lintels of metal; casement windows of metal; strap-hinges of metal; shims; rocket launching platforms of metal; transport pallets of metal; platforms, prefabricated, of metal; wall tiles of metal; floor tiles of metal; tiles of metal for building; anchor plates; paving slabs of metal; grave slabs of metal; tile floorings of metal; slabs of metal for building; lead seals; loading pallets of metal; handling pallets of metal; trays of metal; stakes of metal for plants or trees; firedogs [andirons]; armour-plating of metal; paving blocks of metal; roof coverings of metal; cladding of metal for building; linings of metal for building; fireplace mantles of metal; steel strip; door panels of metal; floors of metal; sills of metal; bathtub grab bars of metal; ceilings of metal; brazing alloys; gold solder; silver solder; door openers, non-electric; collars of metal for fastening pipes; winding spools of metal, non-mechanical, for flexible hoses; floating docks of metal, for mooring boats; stoppers of

metal; aluminium wire; iron wire; wire of common metal; wire of common metal alloys, except fuse wire; barbed wire; copper wire, not insulated; soldering wire of metal; steel wire; springs [metal hardware]; rods of metal for welding; rods of metal for brazing and welding; rods of metal for brazing; peeled metal bars; drawn and polished metal bars; bright steel bars; hot-rolled steel bars; dispensers for dog waste bags, fixed, of metal; window frames of metal; frames of metal for building; crucifixes of common metal, other than jewellery; containers of metal for liquid fuel; containers of metal for compressed gas or liquid air; reservoirs of metal; floating containers of metal; rails of metal; straps of metal for handling loads; fireplace grates of metal; grilles of metal; runners of metal for sliding doors; iron ores; ores of metal; chrome ores; door handles of metal; knobs of metal; sheet piles of metal; pigsties of metal; lead, unwrought or semi-wrought; safes [metal or non-metal]; safes, electronic; insect screens of metal; burial vaults of metal; door scrapers; cable joints of metal, non-electric; junctions of metal for pipes; nozzles of metal; anti-friction metal; silver-plated tin alloys; alloys of common metal; sheaf binders of metal; bindings of metal; bottle closures of metal; shutters of metal; steel alloys; steel, unwrought or semi-wrought; tinfoil; statues of common metal; figurines of common metal; cask stands of metal; tombstone stelae of metal; bars for metal railings; stables of metal; advertisement columns of metal; posts of metal; telegraph posts of

metal; railway points; steps [ladders] of metal; step stools of metal; slings of metal for handling loads; stair treads [steps] of metal; machine belt fasteners of metal; tombstone plaques of metal; identity plates of metal; tantalum [metal]; greenhouses of metal, transportable; titanium; wire cloth; tombac; mobile boarding stairs of metal for passengers; cables of metal, non-electric; wire rope; pipework of metal; penstock pipes of metal; water-pipes of metal; gutter pipes of metal; ducts of metal for ventilating and air-conditioning installations; drain pipes of metal; chimneys of metal; pipes of metal; ducts of metal, for central heating installations; steel pipes; turnstiles of metal; angle irons of metal; tinsplate packings; door fasteners of metal; bicycle parking installations of metal; window closers, non-electric; window openers, non-electric; wind-driven bird-repelling devices made of metal; towel dispensers, fixed, of metal; tungsten iron; molybdenum iron; silicon iron; titanium iron; chrome iron; flagpoles [structures] of metal; hand-held flagpoles of metal; flanges of metal [collars]; weather- or wind-vanes of metal; aluminium foil; metals in foil or powder form for 3D printers; foils of metal for wrapping and packaging; ice moulds of metal; foundry moulds of metal; fittings of metal for coffins; fittings of metal for beds; fittings of metal for furniture; clips of metal for cables and pipes; chromium; cattle chains; chains of metal; safety chains of metal; zinc; zirconium; cotter pins of metal; pantiles of metal; roofing tiles of metal; cast

Class 7.	<p>iron, unwrought or semi-wrought; washers of metal; balls of steel; hinges of metal; poles of metal; safety cashboxes; pulleys of metal, other than for machines; railroad ties of metal; railway sleepers of metal; window casement bolts; spurs; pins [hardware]; roller blinds of steel; latch bars of metal; badges of metal for vehicles; labels of metal; lock bolts; cashboxes [metal or non-metal]; tool chests of metal, empty; boxes of common metal; letter boxes of metal.</p> <p>Machines, machine tools, power-operated tools; motors and engines, except for land vehicles; machine coupling and transmission components, except for land vehicles; agricultural implements, other than hand-operated hand tools; incubators for eggs; automatic vending machines; 3D printers; welding machines, electric; welding apparatus, gas-operated; vulcanization apparatus; acetylene cleaning apparatus; high pressure washers; apparatus for drawing up beer under pressure; apparatus for aerating water; apparatus for aerating beverages; electrical apparatus for sealing plastics [packaging]; electric arc cutting apparatus; electric arc welding apparatus; electric welding apparatus; inking apparatus for printing machines; soldering apparatus, electric; fittings for engine boilers; expansion tanks [parts of machines]; drums [parts of machines]; reels, mechanical, for flexible hoses; brake shoes, other than for vehicles; concrete mixers [machines]; reels [parts of machines]; bobbins for weaving looms; harrows; journal boxes [parts of machines]; bulldozers;</p>	<p>hoppers [mechanical discharging]; mine borers; railway wagon lifts; rolling mill cylinders; crank shafts; printing rollers for machines; camshafts for vehicle engines; transmission shafts, other than for land vehicles; valves [parts of machines]; fans for motors and engines; saw benches [parts of machines]; winnowers; vibrators [machines] for industrial use; bearings [parts of machines]; water heaters [parts of machines]; bellows [parts of machines]; agitators; exhausts for motors and engines; drilling rigs, floating or non-floating; lawnmowers [machines]; card clothing [parts of carding machines]; nail extractors, electric; emergency power generators; alternators; dynamos; bicycle dynamos; current generators; generators of electricity; hydraulic controls for machines, motors and engines; mufflers for motors and engines; drilling heads [parts of machines]; drilling bits [parts of machines]; cylinder heads for engines; soldering blow pipes, gas-operated; gas-operated blow torches; raking machines; stalk separators [machines]; sieves [machines or parts of machines]; mud catchers and collectors [machines]; tarring machines; rubber tracks being parts of crawlers on mining machines; rubber tracks being parts of crawlers on snow ploughs; rubber tracks being parts of crawlers on loading-unloading machines and apparatus; rubber tracks being parts of crawlers on agricultural machines; rubber tracks being parts of crawlers on construction machines; hydraulic engines and motors; aeronautical engines; aeroplane engines; engines for</p>
----------	---	--

air cushion vehicles;
compressed air engines; jet
engines, other than for land
vehicles; engines for boats;
driving motors, other than for
land vehicles; motors, other
than for land vehicles;
propulsion mechanisms, other
than for land vehicles; de-
aerators for feedwater;
disintegrators; tympan [parts
of printing presses]; holding
devices for machine tools; turf
removing ploughs; pump
diaphragms; door closers,
hydraulic; door closers,
pneumatic; door closers,
electric; chisels for machines;
jacks [machines]; rack and
pinion jacks; moving
sidewalks; electric hand drills;
crushers for kitchen use,
electric; flues for engine
boilers; reapers; reapers and
binders; millstones; rakes for
raking machines; shredders
[machines] for industrial use;
kitchen grinders, electric;
injectors for engines; ski edge
sharpening tools, electric;
tools [parts of machines];
hand-held tools, other than
hand-operated; agricultural
implements, other than hand-
operated; air condensers;
control cables for machines,
engines or motors; capstans;
calenders; rotary steam
presses, portable, for fabrics;
ditchers [ploughs];
carburetters; carriages for
knitting machines; crankcases
for machines, motors and
engines; steamrollers;
pressure valves [parts of
machines]; clack valves [parts
of machines]; pressure
reducers [parts of machines];
cowlings [parts of machines];
machine wheels; freewheels,
other than for land vehicles;
scale collectors for machine
boilers; lasts for shoes [parts
of machines]; brake pads,
other than for vehicles; piston
segments; grease rings [parts

of machines]; reapers and
threshers; coal-cutting
machines; compressors
[machines]; air pumps [garage
installations]; compressors for
refrigerators; conveyors
[machines]; belt conveyors;
converters for steelworks;
steam condensers [parts of
machines]; aerocondensers;
diggers [machines]; rams
[machines]; thermic lances
[machines]; mechanized
livestock feeders; boxes for
matrices [printing]; gear
boxes, other than for land
vehicles; grease boxes [parts
of machines]; housings [parts
of machines]; harvesting
machines; steam engine
boilers; coffee grinders, other
than hand-operated; taps
[parts of machines, engines or
motors]; cranes [lifting and
hoisting apparatus]; roller
bridges; mobile cranes; water
separators; spray guns for
paint; cranks [parts of
machines]; potters' wheels;
grindstones [parts of
machines]; cultivators
[machines]; soldering lamps;
winches; ploughshares; belts
for conveyors; lubricators
[parts of machines]; igniting
magnetos; handling machines,
automatic [manipulators];
churns; matrices for use in
printing; machine fly-wheels;
hair clipping machines for
animals; paper machines;
blowing machines; knitting
machines; galvanizing
machines; bending machines;
ironing machines;
mineworking machines;
blowing machines for the
compression, exhaustion and
transport of gases; blowing
machines or fans for the
compression, sucking and
carrying of grain; net hauling
machines [fishing];
electroplating machines;
bottle sealing machines;
sealing machines for

industrial purposes;
embossing machines;
engraving machines; finishing
machines; crushing machines;
waste disposal units; blade
sharpening [stropping]
machines; earth moving
machines; cord making
machines; lace making
machines; butter machines;
cigarette machines for
industrial purposes; sausage
making machines; stereotype
machines; hosiery looms;
grinding machines; dyeing
machines; bottle washing
machines; dishwashers; bottle
filling machines; racket
stringing machines; leather-
working machines; dairy
machines; glass-working
machines; tobacco processing
machines; grain husking
machines; painting machines;
oil refining machines; peeling
machines; machines for
processing plastics; ore
treating machines; printing
machines for use on sheet
metal; brewing machines;
whitewashing machines; road
sweeping machines, self-
propelled; leather paring
machines; bitumen making
machines; papermaking
machines; pasta making
machines, electric; machines
for the production of sugar;
weeding machines; sifting
machines; cinder sifters
[machines]; puddling
machines; notchers [machine
tools]; bread cutting
machines; road making
machines; railroad
constructing machines;
machines for the textile
industry; rammers [machines];
rail-laying machines; bottle
capping machines; bottle
stoppering machines;
packaging machines; waste
compacting machines; die-
stamping machines; stamping
machines; darning machines;
milking machines; drainage

machines; wrapping
machines; grain separators;
bookbinding apparatus and
machines for industrial
purposes; machines and
apparatus for cleaning,
electric; machines and
apparatus for carpet
shampooing, electric;
machines and apparatus for
polishing [electric]; sizing
machines; punching
machines; riveting machines;
kitchen machines, electric;
foundry machines; smoothing
presses; fleshing machines;
rinsing machines; flour mill
machines; type-setting
machines [printing]; hemming
machines; grating machines
for vegetables; braiding
machines; wringing machines
for laundry; cutting machines;
steam engines; printing
machines; rotary printing
presses; industrial inkjet
printing machines;
compressed air machines;
tilling machines for
agricultural purposes;
trimming machines; spinning
machines; filling machines;
friezing machines; cutters
[machines]; satinizing
machines; agricultural
machines; mixing machines;
sorting machines for industry;
stitching machines; washing
machines [laundry]; coin-
operated washing machines;
clippers [machines]; spinning
frames; spin driers [not
heated]; looms; kneading
machines; typographic
machines; type-setting
machines [photocomposition];
beating machines; beaters,
electric; packing machines;
filtering machines; molding
machines; carding machines;
sewing machines; typecasting
machines; electromechanical
machines for chemical
industry; labellers [machines];
mills [machines]; mills for
household purposes, other

than hand-operated; pepper mills, other than hand-operated; centrifugal mills; machine wheelwork; feeders [parts of machines]; forge blowers; mixers [machines]; blenders, electric, for household purposes; vacuum cleaner bags; threshing machines; pneumatic hammers; hammers [parts of machines]; tilt hammers; power hammers; reeling apparatus, mechanical; motorized cultivators; motors for boats; clutches, other than for land vehicles; meat choppers [machines]; superchargers; brake linings, other than for vehicles; guides for machines; suction nozzles for vacuum cleaners; vacuum cleaner attachments for disseminating perfumes and disinfectants; pumps [machines]; pumps [parts of machines, engines or motors]; aerating pumps for aquaria; vacuum pumps [machines]; compressed air pumps; pumps for heating installations; beer pumps; pumps for counter-current swimming; lubricating pumps; self-regulating fuel pumps; fuel dispensing pumps for service stations; centrifugal pumps; hydrogen dispensing pumps for service stations; blades [parts of machines]; can openers, electric; knives for mowing machines; chaff cutter blades; knives, electric; shears, electric; scissors, electric; vegetable spiralizers, electric; engine mounts, other than for land vehicles; bearing brackets for machines; pulverisers [machines]; axles for machines; steam traps; chucks [parts of machines]; drill chucks [parts of machines]; exhaust manifold for engines; soldering irons, gas-operated; soldering irons, electric; superheaters; gears,

other than for land vehicles; reduction gears, other than for land vehicles; drilling machines; saws [machines]; chain saws; guns [tools using explosives]; glue guns, electric; compressed air guns for the extrusion of mastics; carburetter feeders; feeding apparatus for engine boilers; loading ramps; ploughs; pneumatic transporters; pneumatic controls for machines, motors and engines; hangers [parts of machines]; anti-friction bearings for machines; roller bearings; self-oiling bearings; bearings for transmission shafts; ball-bearings; elevators [lifts]; hoists; lifts, other than ski-lifts; pulleys; saw blades [parts of machines]; pistons [parts of machines or engines]; shock absorber plungers [parts of machines]; pistons for engines; pistons for cylinders; catalytic converters; torque converters, other than for land vehicles; fuel conversion apparatus for internal combustion engines; presses [machines for industrial purposes]; wine presses; basket presses; fruit presses, electric, for household purposes; fodder presses; printing presses; typographic presses; swaging machines; pedal drives for sewing machines; cleaning appliances utilizing steam; food processors, electric; springs [parts of machines]; spinning wheels; punches for punching machines; vacuum cleaners; tambours for embroidery machines; radiators [cooling] for motors and engines; sewage pulverizers; sewage pulverisers; air brushes for applying colour; regulators [parts of machines]; pressure regulators [parts of machines]; speed governors for machines,

engines and motors; knives [parts of machines]; cutting blow pipes, gas-operated; blade holders [parts of machines]; loom shafts; gears for weaving looms; belts for machines; elevator belts; fan belts for motors and engines; dynamo belts; belts for motors and engines; adhesive bands for pulleys; industrial robots; 3D printing pens; kick starters for motorcycles; joysticks being parts of machines, other than for game machines; stuffing boxes [parts of machines]; paper feeders [printing]; whisks, electric, for household purposes; sparking plugs for internal combustion engines; glow plugs for Diesel engines; brake segments, other than for vehicles; tedding machines; steam/oil separators; cream/milk separators; ball rings for bearings; sowers [machines]; pigs for cleaning pipes; snow ploughs; sheaf-binding machines; shaft couplings [machines]; juice extractors, electric; chaff cutters; suction cups for milking machines; stands for machines; machine tools; die-cutting and tapping machines; woodworking machines; sharpening machines; bicycle assembling machines; mortising machines; stone-working machines; metalworking machines; threading machines; planing machines; lathes [machine tools]; milling machines; trueing machines; metal drawing machines; rolling mills; starters for motors and engines; stators [parts of machines]; glaziers' diamonds [parts of machines]; tables for machines; derricks; slide rests [parts of machines]; couplings, other than for land vehicles; heat exchangers [parts of machines]; transmissions for machines;

transmissions, other than for land vehicles; boiler tubes [parts of machines]; wind turbines; hydraulic turbines; turbines, other than for land vehicles; turbocompressors; connecting rods for machines, motors and engines; joints [parts of engines]; central vacuum cleaning installations; suction machines for industrial purposes; machines for the mineralisation of drinking water; washing installations for vehicles; degreasers [machines]; dust exhausting installations for cleaning purposes; sifting installations; pneumatic tube conveyors; dust removing installations for cleaning purposes; condensing installations; pneumatic waste oil drainers; lifting apparatus; air suction machines; dividing machines; igniting devices for internal combustion engines; window closers, hydraulic; window closers, electric; window closers, pneumatic; washing apparatus; binding apparatus for hay; extractors for mines; door openers, hydraulic; door openers, pneumatic; door openers, electric; window openers, hydraulic; window openers, pneumatic; window openers, electric; curtain drawing devices, electrically operated; adhesive tape dispensers [machines]; anti-pollution devices for motors and engines; beverage preparation machines, electromechanical; food preparation machines, electromechanical; elevator operating apparatus; control mechanisms for machines, engines or motors; shoe polishers, electric; machines and apparatus for wax-polishing, electric; air cushion devices for moving loads; handling apparatus for loading and unloading; elevating

apparatus; aprons [parts of machines]; filter presses; filters for cleaning cooling air, for engines; filters being parts of machines or engines; molds [parts of machines]; printing plates; journals [parts of machines]; centrifugal machines; elevator chains [parts of machines]; driving chains, other than for land vehicles; transmission chains, other than for land vehicles; cylinders for motors and engines; cylinders for machines; printing cylinders; pneumatic jacks; shuttles [parts of machines]; universal joints [Cardan joints]; steam mops; pulleys [parts of machines]; vacuum cleaner hoses; screwdrivers, electric; brushes [parts of machines]; dynamo brushes; brushes for vacuum cleaners; brushes, electrically operated [parts of machines]; carbon brushes [electricity]; ejectors; robotic exoskeleton suits, other than for medical purposes; fuel economisers for motors and engines; excavators; shovels, mechanical; agricultural elevators; motors, electric, other than for land vehicles; electrodes for welding machines; electric hammers; parquet wax-polishers, electric; cartridges for filtering machines; moving staircases [escalators]; automatic grapnels for marine purposes.

Class 19. Materials, not of metal, for building and construction; rigid pipes, not of metal, for building; asphalt, pitch, tar and bitumen; transportable buildings, not of metal; monuments, not of metal; aquaria [structures]; alabaster; door frames, not of metal; asbestos cement; asphalt; beams, not of metal; balustrades, not of metal; huts; swimming pools

[structures], not of metal; silos, not of metal; harbours [structures], not of metal; concrete; bitumen; plastic landscape edgings; joists, not of metal; telephone booths, not of metal; beacons, not of metal, non-luminous; building paper; busts of stone, concrete or marble; bird baths [structures], not of metal; binding agents for making briquettes; binding material for road repair; stained-glass windows; felt for building; aviaries [structures], not of metal; gates, not of metal; diving boards, not of metal; geotextiles; gypsum [building material]; plaster; potters' clay; earth for bricks; clay; gravel; aquarium gravel; granite; armored doors, not of metal; doors, not of metal; swing doors, not of metal; accordion doors, not of metal; folding doors, not of metal; coal tar; chimney pots, not of metal; prefabricated houses [kits], not of metal; parquet floor boards; memorial plaques, not of metal; roofing shingles; wood for making household utensils; veneer wood; moldable wood; flagpoles [structures], not of metal; chimney shafts, not of metal; outdoor blinds, not of metal and not of textile; jalousies, not of metal; roof gutters, not of metal; street gutters, not of metal; agglomerated bagasses of cane [building material]; road signs, non-luminous and non-mechanical, not of metal; non-luminous and non-mechanical signs, not of metal; limestone; lime; fences, not of metal; works of stonemasonry; works of art of stone, concrete or marble; cabanas, not of metal; stone; rubble; artificial stone; building stone; paint spraying booths, not of metal; gravestones; reeds for

building; greenhouse frames, not of metal; framework, not of metal, for building; cornices, not of metal; bitumen paper for building; wood pulp board for building; paperboard for building; skating rinks [structures], not of metal; quartz; caissons for construction work under water; bricks; fire burrs; water-pipe valves, not of metal or plastic; drain traps [valves], not of metal or plastic; cask wood; mooring bollards, not of metal; pillars, not of metal, for building; cement posts; chimney cowls, not of metal; brackets, not of metal, for building; buildings, not of metal; buildings, transportable, not of metal; stringers [parts of staircases], not of metal; silica [quartz]; roofing, not of metal; manhole covers, not of metal; xylolith; chicken-houses, not of metal; manufactured timber; sawn timber; building timber; wood, semi-worked; staircases, not of metal; road marking sheets and strips of synthetic material; reinforcing materials, not of metal, for building; bituminous products for building; tar; road coating materials; materials for making and coating roads; grog [fired refractory material]; pitch; refractory construction materials, not of metal; masts [poles], not of metal; raw chalk; calcareous marl; mosaics for building; moldings, not of metal, for cornices; moldings, not of metal, for building; marble; slate powder; porches [structures], not of metal; tombs, not of metal; flashing, not of metal, for building; roof flashing, not of metal; perches; duckboards, not of metal; wall claddings, not of metal, for building; coatings [building materials]; tomb or

grave enclosures, not of metal; laths, not of metal; wood panelling; wall linings, not of metal, for building; palisading, not of metal; crash barriers, not of metal, for roads; trellises, not of metal; windows, not of metal; olivine for building; shuttering, not of metal, for concrete; poles, not of metal, for power lines; props, not of metal; rubber bearings for seismic isolation of buildings; branching pipes, not of metal; fair huts; tombs [monuments], not of metal; wainscotting, not of metal; signalling panels, non-luminous and non-mechanical, not of metal; building panels, not of metal; parquet flooring; partitions, not of metal; lintels, not of metal; casement windows, not of metal; aquarium sand; silver sand; sand, except foundry sand; sandstone for building; tarred strips for building; planks of wood for building; rocket launching platforms, not of metal; platforms, prefabricated, not of metal; wall tiles, not of metal; floor tiles, not of metal; tiles, not of metal, for building; paving slabs, not of metal; cement slabs; grave slabs, not of metal; tile floorings, not of metal; slabs, not of metal, for building; scaffolding, not of metal; armour-plating, not of metal; asphalt paving; wood paving; paving blocks, not of metal; luminous paving blocks; macadam; fireproof cement coatings; bituminous coatings for roofing; roof coverings, not of metal; roofing, not of metal, incorporating photovoltaic cells; wooden floor boards; cladding, not of metal, for building; linings, not of metal, for building; fireplace mantles, not of metal; door panels, not of

metal; floors, not of metal; sills, not of metal; porphyry [stone]; ceilings, not of metal; floating docks, not of metal, for mooring boats; agglomerated cork for building; window frames, not of metal; mortar for building; asbestos mortar; tanks of masonry; scantlings [carpentry]; furrings of wood; vinyl siding; sheet piles, not of metal; pigsties, not of metal; insect screens, not of metal; burial vaults, not of metal; schists; shutters, not of metal; statues of stone, concrete or marble; statuettes of stone, concrete or marble; alabaster glass; safety glass; glass granules for road marking; window glass for building; window glass, other than vehicle window glass; building glass; plate glass [windows] for building; insulating glass for building; enamelled glass, for building; tombstone stelae, not of metal; stables, not of metal; advertisement columns, not of metal; posts, not of metal; telegraph posts, not of metal; hips for roofing; stair-treads [steps], not of metal; tombstone plaques, not of metal; greenhouses, transportable, not of metal; terra-cotta [building material]; penstock pipes, not of metal; water-pipes, not of metal; gutter pipes, not of metal; ducts, not of metal, for ventilating and air-conditioning installations; drain pipes, not of metal; chimneys, not of metal; sandstone pipes; turnstiles, not of metal; tufa; angle irons, not of metal; lengthening pieces, not of metal, for chimneys; bicycle parking installations, not of metal; plywood; foundry moulds, not of metal; rock crystal; cement for blast furnaces; cement for furnaces;

magnesia cement; cement; pantiles, not of metal; roofing tiles, not of metal; slate; roofing slates; slag [building material]; clinker stone; railway sleepers, not of metal; wood veneers; clinker ballast; concrete building elements; letter boxes of masonry.

Class 31. Raw and unprocessed agricultural, aquacultural, horticultural and forestry products; raw and unprocessed grains and seeds; fresh fruits and vegetables, fresh herbs; natural plants and flowers; bulbs, seedlings and seeds for planting; live animals; foodstuffs and beverages for animals; malt; algarovilla for animal consumption; anchovy, live; oranges, fresh; peanuts, fresh; artichokes, fresh; draff; beans, fresh; locust beans, raw; wreaths of natural flowers; grapes, fresh; algae, unprocessed, for human or animal consumption; fruit residue [marc]; marc; dog biscuits; sea-cucumbers, live; peas, fresh; buckwheat, unprocessed; mushroom spawn for propagation; mushrooms, fresh; trees; palm trees; turf, natural; unsawn timber; undressed timber; yeast for animal consumption; Christmas trees; edible chews for animals; menagerie animals; peanut cake for animals; oil cake; maize cake for cattle; rape cake for cattle; bagasses of cane [raw material]; cereal seeds, unprocessed; grains [cereals]; grains for animal consumption; lime for animal forage; fish spawn; vegetable marrows, fresh; cocoa beans, raw; koi carp, live; potatoes, fresh; chestnuts, fresh; quinoa, unprocessed; arrangements of fresh fruit; copra; raw barks; rough cork; animal foodstuffs; pet food; stall food for

animals; bird food; strengthening animal forage; chicory roots; roots for animal consumption; nettles; groats for poultry; maize; edible sesame, unprocessed; shrubs; rose bushes; spiny lobsters, live; lemons, fresh; vine plants; salmon, live; onions, fresh; flower bulbs; leeks, fresh; olives, fresh; bran mash for animal consumption; shellfish, live; almonds [fruits]; mussels, live; peanut meal for animals; linseed meal for animal consumption; meal for animals; flax meal [fodder]; rice meal for forage; fish meal for animal consumption; straw mulch; beverages for pets; edible insects, live; oats; vegetables, fresh; cucumbers, fresh; lobsters, live; nuts [fruits]; coconuts; kola nuts; bran; distillery waste for animal consumption; residue in a still after distillation; palms [leaves of the palm tree]; cuttle bone for birds; peppers [plants]; aromatic sand [litter] for pets; citrus fruit, fresh; litter for animals; mash for fattening livestock; unprocessed sweet corn ears [husked or unhusked]; animal fattening preparations; preparations for egg laying poultry; fishing bait, live; by-products of the processing of cereals, for animal consumption; seed germ for botanical purposes; poultry, live; wheat; pollen [raw material]; crayfish, live; crustaceans, live; seedlings; plants; aloe vera plants; plants, dried, for decoration; rhubarb, fresh; rice, unprocessed; rye; wheat germ for animal consumption; fish, live; lettuce, fresh; sardines, live; beet, fresh; herrings, live; seeds for planting; linseed for animal consumption; edible linseed, unprocessed; hay;

coconut shell; bred stock; sanded paper [litter] for pets; malt for brewing and distilling; straw [forage]; straw litter; salt for cattle; trunks of trees; wood chips for the manufacture of wood pulp; litter peat; garden herbs, fresh; sugarcane; truffles, fresh; tuna, live; squashes, fresh; oysters, live; fruit, fresh; hazelnuts, fresh; fodder; hops; flowers, natural; flowers, dried, for decoration; chicory, fresh; silkworms; garlic, fresh; lentils, fresh; pine cones; hop cones; spinach, fresh; juniper berries; berries, fresh; eggs for hatching, fertilised; silkworm eggs; barley.

Priority Date Claimed: 04 June 2019 Russian Federation

Makalini Greenhouse, Ltd, Promyshlennaya street, 1, office 232, Chekhov district, RU-142305 Sergeevo village, Moscow region, Russian Federation

Representative: Kovalenko Natalia
Valentinovna, ul. Frunzenskaya
Nabereznaya, 38, korp. 1, kv.
136, RU-119270 Moscow,
Russian Federation



1493770 23/05/2019

Class 7. Milking machines and their parts.

ANGEL LOSADA URIGÜEN Y WALDO LOSADA
URIGÜEN, Calle Gobela, N° 1, E-48610 URDULIZ,
Spain

Representative: MARIA ANTONIA EZCURRA
ZUFIA, Iparraguirre, 15-2° A,
E-48009 BILBAO, Spain

BY WE

1494800 03/05/2019

- Class 9. Computer application software for users to manage membership in co-working facilities, reserve conference rooms, control employees' user access, order printing services, participate in business and social networking, engage in virtual communities, search job listings, and sign up and pay for vendor services; digital and electronic signage for exterior and interior use.
- Class 16. Printed paper exterior and interior signs; stickers; posters.
- Class 35. Providing business and office function services, namely hire, lease and rental of office equipment, telecommunications equipment and office machines; organisation for a third party of telephone receptionist services; business information services; business development services, namely, providing start-up support for businesses of others; office support staff recruitment services; secretarial services; online business networking services; business consultation services in the nature of office space

design; business management and organization consultancy; real estate marketing analysis; providing electronic tracking of real estate assets to others for business purposes; planning, maintenance, tracking and reporting of real estate construction projects for third parties for business purposes; advertising of commercial real estate; advertising of residential real estate; advertising of commercial or residential real estate; providing office support staff services; business project management for others; business consulting services in the fields of spatial layout and infrastructure architecture and interior design; business consulting services in the field of spatial management to optimize business process efficiency and decision-making; computer-aided optimization and management, namely, managing logistics and physical spaces; retail store services relating to computer hardware, computer software, computer peripherals, information technology equipment, telecommunications equipment, accessories and chargers for computer hardware, computer software, computer peripherals, paper, stationery, printed publications, office requisites, food, beverages; online retail store services relating to computer hardware, computer software, computer peripherals, information technology equipment, telecommunications equipment, accessories and chargers for computer hardware, computer software, computer peripherals, paper, stationery, printed

- publications, office requisites, food, beverages.
- Class 36. Insurance; financial affairs; monetary affairs; real estate affairs; real estate services; leasing of commercial and residential real estate; rental of office space; rental of co-working offices and facilities; rental of apartments and buildings; management of apartments and buildings; incubation services, namely, rental of office space to freelancers, start-ups, existing businesses and non-profits; fundraising services; charitable fundraising services; art brokerage; art appraisal; health insurance services; life insurance; banking services; credit card, debit card and charge card services; financial transaction authorization and settlement services; electronic payment processing, authentication and verification services; advisory services in relation to the aforementioned services; financial services; providing grants; investment services; charitable services, namely, granting funds to not-for-profit entities; incubation services, namely, providing work space containing business equipment and other amenities to emerging, start-up and existing companies.
- Class 43. Services for providing food and drink; café, bar, cafeteria and restaurant services; catering services; lounge services; providing community centers for social gatherings and meetings; providing conference, exhibition and meeting facilities; rental of facilities and meeting rooms for business and social events; providing day care services; pet day care services; booking and reservation services for temporary accommodation,

hotels, restaurants bars, catering services, and for placing orders for food delivery and pick up; rental of bed and bath linens; rental of table linens; food preparation services featuring meals for delivery or pickup; providing information in the field of recipes and cooking from a computer database; rental of conference rooms.

Priority Date Claimed: 07 January 2019 United States of America

WeWork Companies Inc., 115 West 18th Street, New York NY 10011, United States of America

Representative: Nadine H. Jacobson FROSS
ZELNICK LEHRMAN &
ZISSU, P.C., 4 Times Square,
17th Floor, New York NY
10036, United States of
America

Address for service: FRKelly, 27 Clyde Road,
Ballsbridge, Dublin 4, Ireland

SCALE AVIATION

1498935 27/09/2019

- Class 36. Aircraft financing services; investment in aircraft; investment consultation in the field of aviation and aircraft ownership; financial services; financial and investment services, namely, aircraft asset and investment acquisition, consultation, advisory and development.
- Class 39. Leasing of aircraft.

Altitude Finance Ireland I DAC, 25-28 North Wall Quay, IFSC, Dublin 1, D01 H104, Ireland

Representative: John P. Rynkiewicz Arnold & Porter Kaye Scholer LLP, 601 Massachusetts Ave., N.W., Washington DC 20001, United States of America

ASTOTLEO

1498952 04/10/2019

Class 5. Pharmaceutical preparations for use in the treatment of cancer and auto-immune diseases, diseases in the fields of oncology, immunology and inflammation; pharmaceutical preparations, namely, cytokine inhibitory drugs; pharmaceutical preparations that modulate the immune system; pharmaceutical preparations, namely, preparations for use in the treatment of tumors; pharmaceutical and biological preparations for immunotherapy, including T-Cell therapy; cells for medical or clinical use; diagnostic kits consisting primarily of cells for medical or clinical use.

Priority Date Claimed: 26 September 2019 United States of America

Celgene Corporation, 86 Morris Avenue, Summit NJ 07901, United States of America

Representative: Camille M. Miller Cozen O'Connor, 1650 Market Street, Suite 2800, Philadelphia PA 19103, United States of America

VAMEDIA

1498955 02/08/2019

Class 35. Advertising via electronic media and specifically the Internet; social media marketing.

Class 38. Video, audio and television streaming services.

Priority Date Claimed: 28 May 2019 Austria

VAMED Aktiengesellschaft, Sterngasse 5, A-1230 Wien, Austria

Representative: Saxinger, Chalupsky & Partner Rechtsanwälte GmbH, Edisonstraße 1, A-4600 Wels, Austria

HERMES ANTIOCHE

1499026 19/09/2019

Class 14. Precious metals and their alloys, precious stones, jewelry, costume jewelry, necklaces (jewelry), long necklaces (jewelry), chokers (jewelry), bracelets (jewelry), rings (jewelry), earrings (jewelry), pendants (jewelry), brooches (jewelry), badges (jewelry), cuff links (jewelry), medals (jewelry), medallions (jewelry), charms (jewelry), jewelry for the head, jewelry for the body, jewelry for the hands, tie clips, tie pins, chains (jewelry), boxes of precious metals, jewelry caskets, boxes for watches not of precious metal, jewelry pouches not of precious metal, watch pouches not of precious

metal, horological and chronometric instruments, watches and structural parts thereof, chronographs (watches), chronometers, wristwatches, clocks, pendulums (clocks), small clocks, watch bands, clasps for watches, dials for watches, watch cases, watch chains, movements for clocks and watches, cases for clock and watchmaking, cases for jewelry (presentation), cases for watches (presentation), novelty key rings.

Priority Date Claimed: 05 April 2019 France

HERMES INTERNATIONAL, 24, rue du Faubourg Saint-Honoré, F-75008 PARIS, France

Representative: HERMES INTERNATIONAL, M. Nicolas MARTIN, 24 rue du Faubourg Saint-Honoré, F-75008 PARIS, France

REPONSE

1499104 19/09/2019

Class 14. Precious metals and their alloys, precious stones, jewelry, costume jewelry, necklaces (jewelry), long necklaces (jewelry), chokers (jewelry), bracelets (jewelry), rings (jewelry), earrings (jewelry), pendants (jewelry), brooches (jewelry), badges (jewelry), cuff links (jewelry), medals (jewelry), medallions (jewelry), charms (jewelry), jewelry for the head, jewelry for the body, jewelry for the hands, tie clips, tie pins, chains (jewelry), boxes of precious metals, jewelry caskets, boxes for watches not

of precious metal, jewelry pouches not of precious metal, watch pouches not of precious metal, horological and chronometric instruments, watches and structural parts thereof, chronographs (watches), chronometers, wristwatches, clocks, pendulums (clocks), small clocks, watch bands, clasps for watches, dials for watches, watch cases, watch chains, movements for clocks and watches, cases for clock and watchmaking, cases for jewelry (presentation), cases for watches (presentation), novelty key rings.

Priority Date Claimed: 05 April 2019 France

HERMES INTERNATIONAL, 24, rue du Faubourg Saint-Honoré, F-75008 PARIS, France

Representative: HERMES INTERNATIONAL, M. Nicolas MARTIN, 24 rue du Faubourg Saint-Honoré, F-75008 PARIS, France

LELLOKEY

1499441 04/10/2019

Class 5. Pharmaceutical preparations for use in the treatment of cancer and auto-immune diseases, diseases in the fields of oncology, immunology and inflammation; pharmaceutical preparations, namely, cytokine inhibitory drugs; pharmaceutical preparations that modulate the immune system; pharmaceutical preparations, namely, preparations for use in the treatment of tumors; pharmaceutical and biological

preparations for immunotherapy, including T-Cell therapy; cells for medical or clinical use; diagnostic kits consisting primarily of cells for medical or clinical use.

Priority Date Claimed: 26 September 2019 United States of America

Celgene Corporation, 86 Morris Avenue, Summit NJ 07901, United States of America

Representative: Melanie A. Miller, J. Trevor Cloak, Chanel L. Latt Cozen O'Connor, 1650 Market Street, Suite 2800, Philadelphia PA 19103, United States of America

ENHARNEX

1499452 04/10/2019

Class 5. Pharmaceutical preparations for use in the treatment of cancer and auto-immune diseases, diseases in the fields of oncology, immunology and inflammation; pharmaceutical preparations, namely, cytokine inhibitory drugs; pharmaceutical preparations that modulate the immune system; pharmaceutical preparations, namely, preparations for use in the treatment of tumors; pharmaceutical and biological preparations for immunotherapy, including T-Cell therapy; cells for medical or clinical use; diagnostic kits consisting primarily of cells for medical or clinical use.

Priority Date Claimed: 26 September 2019 United States of America

Celgene Corporation, 86 Morris Avenue, Summit NJ 07901, United States of America

Representative: Camille M. Miller Cozen O'Connor, 1650 Market Street, Suite 2800, Philadelphia PA 19103, United States of America

PARADE

1499487 12/09/2019

Class 5. Fungicides only for agricultural purposes.

Priority Date Claimed: 20 May 2019 Japan

NIHON NOHYAKU CO., LTD., 19-8, Kyobashi 1-chome, Chuo-ku, Tokyo 104-8386, Japan

Representative: Asamura Patent Office, p.c., Tennoz Central Tower, 2-2-24, Higashi-Shinagawa, Shinagawa-ku, Tokyo 140-0002, Japan

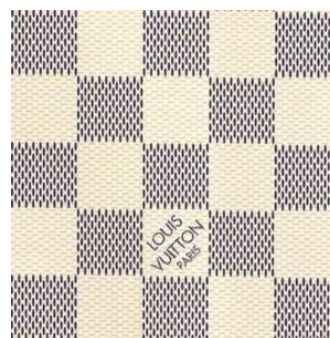

1499932 22/05/2019

Class 18. Boxes of leather or of imitations of leather; traveling bags, traveling sets (leather goods), trunks and suitcases,

garment and footwear bags for travel; unfitted vanity cases; backpacks, handbags; sports bags; clutches (evening handbags), attache cases and document holders of leather; wallets, purses, card cases (wallets), key cases (leather goods); parasols, umbrellas; clothing for animals, bags for carrying animals.

Priority Date Claimed: 26 November 2018 France

LOUIS VUITTON MALLETIER, 2 rue du Pont-Neuf, F-75001 Paris, France

Representative: SOCIETE LOUIS VUITTON SERVICES, Direction Propriété Intellectuelle, Madame SOPHIE REGISSER, 2 rue du Pont-Neuf, F-75001 Paris, France

FRUITZ

1500053 15/10/2019

Class 42. Technical evaluations concerning design (engineers' services); scientific research; technical research; design of computers for third parties; computer development; software design; software development; research and development of new products for third parties; conducting of technical project studies; architecture; design of interior decor; software development (design); software installation; maintenance of software; updating of software; software rental; programming for computers; computer system analysis; computer system design; services provided by consultants relating to computer hardware design

and development; digitization of documents; software as a service (SaaS); cloud computing; information technology (IT) consultancy; hosting of servers; vehicle roadworthiness testing; graphic arts design services; authentication of works of art; electronic data storage.

FLASHGAP, 92 rue d'Aboukir, F-75002 PARIS, France

LUCKY FLY

1500092 11/09/2019

Class 32. Beer; non-alcoholic beverages; mineral and aerated waters; fruit beverages and fruit juices; syrups and other non-alcoholic preparations for making beverages; aperitifs, non-alcoholic; barley wine [beer]; aerated water; lithia water; seltzer water; soda water; waters [beverages]; mineral water [beverages]; table waters; kvass [non-alcoholic beverage]; cocktails, non-alcoholic; beer-based cocktails; lemonades; isotonic beverages; non-alcoholic honey-based beverages; rice-based beverages, other than milk substitutes; soya-based beverages, other than milk substitutes; aloe vera drinks, non-alcoholic; whey beverages; protein-enriched sports beverages; soft drinks; non-alcoholic beverages flavored with coffee; non-alcoholic beverages flavored with tea; non-alcoholic fruit juice beverages; energy drinks; fruit nectars, non-

alcoholic; orgeat; ginger beer; malt beer; powders for effervescing beverages; sarsaparilla [non-alcoholic beverage]; syrups for lemonade; syrups for beverages; smoothies [fruit and vegetable based beverages]; tomato juice [beverage]; cider, non-alcoholic; vegetable juices [beverages]; fruit juices; non-alcoholic preparations for making beverages; preparations for making aerated water; must; grape must, unfermented; beer wort; malt wort; pastilles for effervescing beverages; sherbets [beverages]; non-alcoholic fruit extracts; extracts of hops for making beer; essences for making beverages.

Class 33. Spirits [beverages]; alcoholic beverages (except beer); aperitifs; arrack [arak]; baijiu [Chinese distilled alcoholic beverage]; brandy; wine; piquette; whisky; vodka; anisette [liqueur]; kirsch; gin; digesters [liqueurs and spirits]; cocktails; curacao; anise [liqueur]; liqueurs; pre-mixed alcoholic beverages, other than beer-based; alcoholic beverages containing fruit; distilled beverages; mead [hydromel]; peppermint liqueurs; bitters; nira [sugarcane-based alcoholic beverage]; rum; sake; perry; cider; rice alcohol; alcoholic extracts; fruit extracts, alcoholic; alcoholic essences.

Priority Date Claimed: 05 September 2019 Russian Federation

F&I Energy AG., Baarerstrasse 52, CH-6300 Zug, Switzerland

Representative: "Ermakova, Stoliarova & Partners", Patent Agency, Shmitovskiy proezd, d. 2, str. 2, RU-123100 Moscow, Russian Federation

STRATEGIC COMMERCIAL AVIATION LIQUIDITY ENTERPRISE

1500187 09/10/2019

Class 36. Aircraft financing services; investment in aircraft; investment consultation in the field of aviation and aircraft ownership; financial services; financial and investment services, namely, aircraft asset and investment acquisition, consultation, advisory and development.

Class 39. Leasing of aircraft.

SCALE AVIATION MANAGEMENT
DESIGNATED ACTIVITY COMPANY, 25-28
North Wall Quay, IFSC, Dublin 1 D01H104, Ireland

Representative: John P. Rynkiewicz Arnold & Porter Kaye Scholer LLP, 601 Massachusetts Ave., NW, Washington DC 20001, United States of America

DANCE THE MAGIC

1500317 07/10/2019

Class 39. Travel arrangements; travel and travel information

services, namely, making reservations and bookings for transportation.

- Class 41. Organizing, facilitating and arranging for the production of exhibitions of dance troupes; arranging for dance troupe exhibitions.

Barr, Debi, 7582 Nancy Drive, Huntington Beach CA 92647, United States of America

Representative: Tawnya Wojciechowski TRW Law Group, 19900 MacArthur Boulevard, Suite 530, Irvine CA 92612, United States of America

barrels [clock- and watchmaking]; beads for making jewelry; boxes of precious metal; bracelets [jewelry]; brooches [jewelry]; busts of precious metal; chains [jewelry]; charms for key rings; chronographs [watches]; chronometers; chronometric instruments; chronoscopes; clock cases; clock hands; clocks and watches, electric; clocks; clockworks; coins; control clocks [master clocks]; copper tokens; cufflinks; dials [clock- and watchmaking]; diamonds; earrings; figurines of precious metal; gold thread [jewelry]; gold, unwrought or beaten; hat jewelry; ingots of precious metals; iridium; ivory jewelry; jet, unwrought or semi-wrought; jewellery charms; jewelry; jewelry boxes; jewelry of yellow amber; lockets [jewelry]; medals; movements for clocks and watches; necklaces [jewelry]; olivine [gems]; ornamental pins; ornaments of jet; osmium; palladium; paste jewelry [costume jewelry]; pearls [jewelry]; pearls made of ambroid [pressed amber]; pins [jewelry]; pendulums [clock- and watchmaking]; platinum [metal]; precious metals, unwrought or semi-wrought; precious stones; presentation boxes for watches; rhodium; rings [jewelry]; ruthenium; semi-precious stones; shoe jewelry; silver thread [jewelry]; silver, unwrought or beaten; spinel [precious stones]; spun silver [silver wire]; statues of precious metal; stopwatches; sundials; threads of precious metal [jewelry]; tie clips; tie pins; watch bands; watch cases [parts of watches]; watch chains; watches; watch glasses; watch hands; watch

SOKOLOV

1500956 30/08/2019

- Class 3. Toilet water; lotions for cosmetic purposes; oils for perfumes and scents; oils for cosmetic purposes; oils for toilet purposes; essential oils; cleansing milk for toilet purposes; soap; cosmetic kits; lipsticks; cosmetic preparations for baths; cleansers for intimate personal hygiene purposes, non medicated; deodorants for human beings or for animals; make-up powder; diamantine [abrasive]; cosmetic preparations for skin care; cosmetic preparations for eyelashes; cosmetics; terpenes [essential oils]; shampoos; dry shampoos.
- Class 9. Eyeglasses; eyeglass frames; optical glass; sunglasses.
- Class 14. Agates; alarm clocks; alloys of precious metal; amulets [jewelry]; anchors [clock- and watchmaking]; atomic clocks; badges of precious metal;

- Class 18. springs; works of art of precious metal; wristwatches. Bags; bags [envelopes, pouches] of leather, for packaging; bags for sports; beach bags; cases of leather or leatherboard; chain mesh purses; clothing for pets; collars for animals; credit card cases [wallets]; handbags; haversacks; key cases; leather leashes; leather straps; parasols; pocket wallets; purses; rucksacks; straps of leather [saddlery]; suitcase handles; travelling bags; trunks [luggage]; umbrella handles; umbrellas.
- Class 25. Clothing; footwear; headwear.
- Class 32. Aperitifs, non-alcoholic; lithia water; seltzer water; soda water; waters [beverages]; mineral water [beverages]; table waters; kvass [non-alcoholic beverage]; cocktails, non-alcoholic; lemonades; aerated water; aloe vera drinks, non-alcoholic; beer wort; cider, non-alcoholic; essences for making beverages; extracts of hops for making beer; fruit juices; fruit nectars, non-alcoholic; ginger beer; grape must, unfermented; isotonic beverages; malt beer; malt wort; must; non-alcoholic beverages; non-alcoholic fruit extracts; non-alcoholic fruit juice beverages; non-alcoholic honey-based beverages; non-alcoholic preparations for making beverages; orgeat; pastilles for effervescing beverages; powders for effervescing beverages; preparations for making aerated water; sarsaparilla [non-alcoholic beverage]; sherbets [beverages]; smoothies; syrups for beverages; syrups for lemonade; tomato juice [beverage]; vegetable juices [beverages]; whey beverages.
- Class 33. Aperitifs; arrack [arak]; brandy; wine; whisky; vodka; gin; anise [liqueur]; liqueurs; digesters [liqueurs and spirits]; curacao; pre-mixed alcoholic beverages, other than beer-based; alcoholic beverages, except beer; alcoholic beverages containing fruit; distilled beverages; fruit extracts, alcoholic; mead [hydromel]; cider; rum; sake; rice alcohol; alcoholic extracts.
- Class 34. Ashtrays for smokers; books of cigarette papers; chewing tobacco; cigar cases; cigar cutters; cigarette cases; cigarette filters; cigarette holders; cigarettes; cigarettes containing tobacco substitutes, not for medical purposes; cigarette tips; cigar holders; cigarillos; cigars; electronic cigarettes; firestones; herbs for smoking; humidors; lighters for smokers; matchboxes; matches; match holders; mouthpieces for cigarette holders; pipe cleaners for tobacco pipes; pipe racks for tobacco pipes; pocket machines for rolling cigarettes; snuff; snuff boxes; spittoons for tobacco users; tips of yellow amber for cigar and cigarette holders; tobacco; tobacco jars; tobacco pipes; tobacco pouches.
- Class 35. Administrative processing of purchase orders; advertising; advertising agency services; advertising by mail order; business auditing; business information; business investigations; business research; commercial information agency services; commercial information and advice for consumers in the choice of products and services; compilation of information into computer databases; compilation of statistics; computerized file

management; cost price analysis; demonstration of goods; direct mail advertising; dissemination of advertising matter; distribution of samples; employment agency services; layout services for advertising purposes; marketing; marketing research; market studies; online advertising on a computer network; opinion polling; organization of exhibitions for commercial or advertising purposes; organization of trade fairs for commercial or advertising purposes; outdoor advertising; presentation of goods on communication media, for retail purposes; price comparison services; procurement services for others [purchasing goods and services for other businesses]; production of advertising films; publication of publicity texts; radio advertising; sales promotion for others; shop window dressing; telemarketing services; television advertising; updating of advertising material; word processing; writing of publicity texts.

SOKOLOV Jewerly Holding AG, Weinmarkt 8, CH-6004 Luzern, Switzerland

Representative: Sergey V. Bevz, P.O. BOX 2, RU-121353 Moscow, Russian Federation

BRONCHOVOX

1501383 22/10/2019

Class 5. Pharmaceutical and medicinal preparations for the treatment

of sore throat; throat lozenges; medicated throat sprays; pharmaceutical preparations for the treatment of throat infections; vitamins and nutritional supplements.

Priority Date Claimed: 20 June 2019 Benelux Office for Intellectual Property (BOIP)

Omega Pharma Innovation & Development NV, Venecoweg 26, B-9810 Nazareth, Belgium

Representative: Omega Pharma IP, Venecoweg 26, B-9810 Nazareth, Belgium

HERMES PETIT JETE

1501420 20/09/2019

Class 14. Precious metals and their alloys, precious stones, jewelry, costume jewelry, necklaces (jewelry), long necklaces (jewelry), chokers (jewelry), bracelets (jewelry), rings (jewelry), earrings (jewelry), pendants (jewelry), brooches (jewelry), badges (jewelry), cuff links (jewelry), medals (jewelry), medallions (jewelry), charms (jewelry), tie clips, tie pins, chains (jewelry), boxes of precious metals, jewelry caskets, boxes for watches not of precious metal, jewelry pouches not of precious metal, watch pouches not of precious metal, horological and chronometric instruments, watches and structural parts thereof, chronographs (watches), chronometers, wristwatches, clocks, pendulums (clocks), small clocks, watch bands, clasps for watches, dials for watches, watch cases, watch chains, movements for clocks

and watches, cases for clock and watchmaking, cases for jewelry (presentation), cases for watches (presentation), novelty key rings, jewelry for the head, jewelry for the body, jewelry for the hands.

Priority Date Claimed: 14 April 2019 France

HERMES INTERNATIONAL, 24 rue du Faubourg Saint-Honoré, F-75008 PARIS, France

CVS KIDNEY CARE

1501677 17/07/2019

- Class 10. Hemodialysis apparatus.
 Class 35. Providing healthcare operations management services for healthcare providers, namely, facilitating the administrative coordination of patient care among health providers, dialysis providers, health plan sponsors, health facilities, pharmacies for medication management, physicians for disease management and psychosocial support, with a particular focus on patients with kidney disease.
- Class 41. Educational services, namely, providing patient education in the form of classes, seminars and workshops and training in the field of kidney disease and treatment.
- Class 44. Medical services; health care services; medical services in the field of nephrology, including, kidney dialysis services and providing in-home treatment for patients with kidney disease; in-home hemodialysis and peritoneal dialysis services.

- Class 45. Providing healthcare case management services for health care coordination, namely, providing care coordination services to healthcare providers and patients for coordinating healthcare services, coordinating the provision of individualized care to patients, facilitating and connecting patients to healthcare providers, dialysis providers, health plan sponsors, medical facilities, pharmacies for medication management, physicians for disease management and psychosocial support, and patient advocacy support groups, with a particular focus on patients with kidney disease.

Priority Date Claimed: 25 February 2019 United States of America

CVS Pharmacy, Inc., Mailcode: 1160, One CVS Drive, Woonsocket RI 02895, United States of America

Representative: Erich G. Rhyhart, One CVS Drive, Mail Code: 1160, Woonsocket RI 02895, United States of America

GIVENCHY L'INSTINCT

1501846 22/10/2019

- Class 3. Toilet soaps; perfumes; eaux de toilette; eaux de parfum; eaux de cologne; cosmetic products; face and body milks, lotions, creams, emulsions and gels for cosmetic use; deodorants for personal use; shower gels; pre-shave and after-shave

lotions; shaving creams, gels
and foams.

Priority Date Claimed: 17 May 2019 France

LVMH FRAGRANCE BRANDS, 77 rue Anatole
France, F-92300 Levallois-Perret, France

Representative: LVMH FRAGRANCE
BRANDS, c/o GUERLAIN,
Direction Juridique, 125 rue du
Président Wilson, F-92300
Levallois-Perret, France

GOLI

1502191 11/10/2019

Class 5. Healthcare products, namely,
dietary supplements,
nutritional supplements,
vitamins, and gummy
vitamins.

Goli Nutrition Inc., Suite 1500, 1 Westmount Square,
Westmount QC H3Z 2P9, Canada

Representative: Ann K. Ford DLA Piper LLP
(US), 500 8th Street NW,
Washington DC 20004, United
States of America

DUNSIL

1502207 11/11/2019

Class 16. Paintbrushes; painters'
brushes; house painters'
rollers; paint trays; adhesive
tapes for stationery purposes;
pencils.

ZHEJIANG NATIVE PRODUCE & ANIMAL BY-
PRODUCTS I/E GROUP CO., LTD., 308 North
Zhongshan Road, Hangzhou, Zhejiang, China

Notings: Translation: DUNSIL appearing
in the mark has no significance
nor is it a term of art in the
relevant trade or industry or as
used in connection with the
goods/services/collective
membership organization listed
in the application, or any
geographical significance.

Representative: BSFD INTELLECTUAL
PROPERTY AGENCY
LIMITED, 807 Huacai Plaza,
No. 16 Guangshun North Street,
Chaoyang District, 100102
Beijing, China

BRISK

1502341 22/07/2019

Class 11. Cooling installations for
water; water purification
installations; water flushing
installations / flushing
apparatus; water intake
apparatus; water softening
apparatus and installations; air
purifying apparatus and
machines; kettles, electric.

Zhejiang Brisk Environmental Technology Limited,
Room 705, Building 7F, No 459, Qige Road, Xiasha
Economic Development Zone, Jianggan District,
Hangzhou, Zhejiang, China

Representative: Beijing SSCX Intellectual
Property Attorney Co., Ltd,
Room 2011, Building 3,
Chengongzhuangzhongli,
Xicheng District, Beijing, China

APPLE AFTERBURNER**1502419** 24/10/2019

Class 9. Computer peripherals, namely, cards used to accelerate video performance in computers.

Priority Date Claimed: 25 April 2019 Jamaica

Apple Inc., One Apple Park Way, Cupertino CA 95014, United States of America

Representative: Thomas R. La Perle Apple Inc., One Apple Park Way, MS: 169-3IPL, Cupertino CA 95014, United States of America

HERMES GRAND JETE**1502494** 20/09/2019

Class 14. Precious metals and their alloys, precious stones, jewelry, costume jewelry, necklaces (jewelry), long necklaces (jewelry), chokers (jewelry), bracelets (jewelry), rings (jewelry), earrings (jewelry), pendants (jewelry), brooches (jewelry), badges (jewelry), cuff links (jewelry), medals (jewelry), medallions (jewelry), charms (jewelry), tie clips, tie pins, chains (jewelry), boxes of precious metals, jewelry caskets, boxes for watches not of precious metal, jewelry pouches not of precious metal, watch pouches not of precious metal, horological and chronometric instruments, watches and structural parts thereof, chronographs (watches), chronometers, wristwatches,

clocks, pendulums (clocks), small clocks, watch bands, clasps for watches, dials for watches, watch cases, watch chains, movements for clocks and watches, cases for clock and watchmaking, cases for jewelry (presentation), cases for watches (presentation), novelty key rings, jewelry for the head, jewelry for the body, jewelry for the hands.

Priority Date Claimed: 14 April 2019 France

HERMES INTERNATIONAL, 24 rue du Faubourg Saint-Honoré, F-75008 PARIS, France

Boneve**1502680** 18/10/2019

Class 31. Animal food; edible chews for domestic animals; foodstuffs and beverages for animals; animal biscuits; digestible chewing bones for dogs; and edible dog treats.

Priority Date Claimed: 28 May 2019 Singapore

YAPPY PETS PTE LTD, 3 Loyang Way 1, #04-01, Singapore 508705, Singapore

Representative: C&H IP LAW LIMITED, 77 High Street, #09-11 High Street Plaza, Singapore 179433, Singapore

DREAM DRIVE

1503056 01/09/2019

Class 35. Promoting business, travel and tourism in the State of California.

California Travel and Tourism Commission,
Compliance Officer, 555 Capitol Mall, Suite 1100,
Sacramento CA 95814, United States of America

Representative: Bret D. Hunter, 555 Capitol
Mall Suite 1100, Compliance
Officer, Sacramento CA 95814,
United States of America

Registration of this Trade Mark gives no right to the exclusive use of "DRIVE"

STEAL

1503073 19/11/2019

Class 28. Board games.

Neil Charles-Jones, 117 David Street, Yelverton,
Blenheim 7201, New Zealand

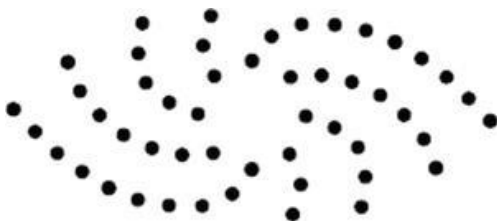

1503097 28/10/2019

Class 9. Scientific, optical, optoelectronic, measuring, signaling apparatus and

instruments; security surveillance and monitoring apparatus; devices for safety, security, protection and signaling; measuring, detection and monitoring instruments, indicators and controllers; apparatus and instruments for the detection and analysis of human activity not for medical use; cameras; sensors; detectors; photosensors; optical detectors and sensors; infrared detectors and sensors; thermal detectors and sensors; heat detectors and sensors; photovoltaic detectors; smart sensors and detectors, i.e., which include integrated software and electronic functions; thermostats; infrared imaging retinas not for medical use; software for monitoring the environment, access and security of buildings; components, namely, semiconductor or optoelectronic components for the aforesaid apparatus and instruments; Electronic apparatus, devices and parts, namely, electronic components, electronic integrated circuits, microprocessors, electronic cards built into optical and optoelectronic apparatus; thermostats and apparatus for temperature control and regulation for vehicles and vehicle engines; video cameras for vehicles; sensors and detectors of objects or persons for vehicles; radar equipment for vehicles; driver assistance systems for automobiles.

Class 10. Detection apparatus for medical use; diagnostic, testing and monitoring equipment for medical use; medical apparatus for patient monitoring comprising an alarm; temperature measuring instruments for medical use;

detectors for medical application; sensors used for medical diagnosis; temperature monitors, sensors and scanners for medical use; precision sensors for medical use; sensors for medical use for monitoring patients' vital signs.

Priority Date Claimed: 07 May 2019 France

LYNRED, Avenue de la Vauve, F-91120
PALAISEAU, France

Representative: Cabinet LAURENT &
CHARRAS, "Le
Contemporain", 50 chemin de la
Bruyère, F-69574 Dardilly
Cedex, France

BATCHPATCH

1503175 08/09/2019

Class 9. Computer software for installing, monitoring, and managing software and software updates on multiple computers.

COCOBOLO SOFTWARE, LLC, PO BOX 30784,
Bethesda MD 20824, United States of America

Representative: Joshua M. Gerben, Esq. Gerben
Law Firm, PLLC, 1050
Connecticut Ave. NW, Suite
500, Washington DC 20036,
United States of America



1503531 05/08/2019

Class 5. Paper tissues impregnated with disinfecting preparations; pesticides; sanitary napkins; compresses; disinfectants; medicines for human purposes; food for babies; depuratives; medicines for veterinary purposes; babies' napkin-pants.

FUJIAN TIME AND TIANHE INDUSTRIAL CO.,
LTD., Honggongshan Development Zone, Honglai
Town, Nanan City, Fujian, China

Notings: Transliteration of the mark: The Chinese characters in the mark transliterate as "BEI BEIKONG JIAN". Translation of the mark or of words contained in the mark: The Chinese characters "BEIBEI" in the mark translate as "precious; shell"; the Chinese characters "KONG JIAN" in the mark translate as "zone". The combination has no meaning.

Representative: FUJIAN LONGER
INTELLECTUAL PROPERTY
SERVICE CO., LTD., Unit
C1D1B2, The Eighth Storey,
Post Office Bldg., No. 458
Xianyue Road, Siming District,
Xiamen, 361012 Fujian
Province, China

AEF**1503694** 19/08/2019

Class 11. Apparatus for lighting, heating, steam generating, cooking, refrigerating, drying, ventilating, water supply and sanitary purposes; lamp shades; steam accumulators; heat accumulators; defrosters for vehicles; distillation apparatus; desiccating apparatus; hydromassage bath apparatus; disinfectant apparatus; air deodorizing apparatus; tanning apparatus [sun beds]; ionization apparatus for the treatment of air or water; coffee roasters; beverage cooling apparatus; hand drying apparatus for washrooms; fruit roasters; water purifying apparatus and machines; refrigerating apparatus and machines; drying apparatus and installations; freezers; drying apparatus; lighting apparatus; coolers for furnaces; expansion tanks for central heating installations; flushing tanks; refining towers for distillation; bidets; boilers, other than parts of machines; bath tubs; spa baths [vessels]; bath tubs for sitz baths; waffle irons, electric; fans [air-conditioning]; fans [parts of air-conditioning installations]; electric fans for personal use; roasting spits; refrigerating display cabinets; heated display cabinets; water heaters; water heaters [apparatus]; water flushing installations; air reheaters; extractor hoods for kitchens; gas condensers, other than parts of machines; acetylene generators; hydrants; burners; acetylene burners; gas burners; burners for lamps; germicidal burners;

incandescent burners; oxyhydrogen burners; laboratory burners; oil burners; alcohol burners; hot water bottles; footwarmers, electric or non-electric; bed warmers; pocket warmers; warming pans; grills [cooking appliances]; lampshade holders; stills; showers; refrigerating containers; gas lighters; lighters; friction lighters for igniting gas; chimney blowers; coils [parts of distilling, heating or cooling installations]; furnace ash boxes; evaporators; shower enclosures; Turkish bath cabinets, portable; heating apparatus; refrigerating chambers; fireplaces, domestic; chimney flues; saucepans, electric; air valves for steam heating installations; level controlling valves in tanks; thermostatic valves [parts of heating installations]; electrically heated carpets; light bulbs; light bulbs, electric; solar thermal collectors [heating]; distillation columns; furnace grates; ventilation hoods; ventilation hoods for laboratories; lamp globes; air-conditioning apparatus; air conditioners for vehicles; gas boilers; laundry room boilers; heating boilers; coffee machines, electric; faucets for pipes and pipelines; taps; mixer faucets for water pipes; forges, portable; lava rocks for use in barbecue grills; electric lights for Christmas trees; acetylene flares; safety lamps; gas lamps; curling lamps; germicidal lamps for purifying air; light bulbs for directional signals for vehicles; arc lamps; laboratory lamps; oil lamps; ultraviolet ray lamps, not for medical purposes; miners' lamps; electric lamps; chandeliers; barbecues; bread

baking machines; watering machines for agricultural purposes; multicookers; footmuffs, electrically heated; heaters for baths; heaters for heating irons; immersion heaters; brackets for gas burners; anti-splash tap nozzles; heat pumps; filaments for electric lamps; magnesium filaments for lighting; heating filaments, electric; luminous house numbers; fan heaters; heating apparatus for defrosting vehicle windows; hot air bath fittings; bath fittings; loading apparatus for furnaces; kiln furniture [supports]; sauna bath installations; refrigerating appliances and installations; blankets, electric, not for medical purposes; fabric steamers; lamp reflectors; vehicle reflectors; hearths; food steamers, electric; steam boilers, other than parts of machines; pasteurisers; lamp mantles; sockets for electric lights; coffee percolators, electric; stoves [heating apparatus]; bakers' ovens; hot air ovens; kitchen ranges [ovens]; microwave ovens [cooking apparatus]; microwave ovens for industrial purposes; incinerators; kilns; solar furnaces; dental ovens; furnaces, other than for laboratory use; urinals being sanitary fixtures; feeding apparatus for heating boilers; heating plates; cookers; hot plates; heaters, electric, for feeding bottles; aquarium heaters; aquarium lights; heating cushions, electric, not for medical purposes; clean chambers [sanitary installations]; tortilla presses, electric; water intake apparatus; deodorizing apparatus, not for personal use; apparatus for dehydrating

food waste; fumigation apparatus, not for medical purposes; gas scrubbing apparatus; oil-scrubbing apparatus; glue-heating appliances; forage drying apparatus; water filtering apparatus; air purifying apparatus and machines; ice machines and apparatus; cooling appliances and installations; cooking apparatus and installations; lighting apparatus and installations; sanitary apparatus and installations; cooking rings; lighting apparatus for vehicles; light-emitting diodes [LED] lighting apparatus; heating apparatus for solid, liquid or gaseous fuels; heating apparatus, electric; hot air apparatus; steam facial apparatus [saunas]; safety accessories for water or gas apparatus and pipes; regulating and safety accessories for gas apparatus; regulating accessories for water or gas apparatus and pipes; regulating and safety accessories for water apparatus; regulating and safety accessories for gas pipes; anti-glare devices for vehicles [lamp fittings]; roasting jacks; plate warmers; electric appliances for making yogurt; rotisseries; radiator caps; diving lights; washers for water faucets; radiators [heating]; central heating radiators; radiators, electric; sinks; disinfectant dispensers for toilets; drip irrigation emitters [irrigation fittings]; light diffusers; nuclear reactors; heat regenerators; pressure water tanks; roasters; lamps; standard lamps; ceiling lights; toilet seats; lighting installations for air vehicles; pressure cookers, electric; gas scrubbers [parts of gas installations]; lamp glasses;

sterilizers; water sterilizers; air sterilizers; air dryers; laundry dryers, electric; hair dryers; malt roasters; tobacco roasters; heat exchangers, other than parts of machines; bread toasters; discharge tubes, electric, for lighting; lamp chimneys; luminous tubes for lighting; pipes [parts of sanitary installations]; flues for heating boilers; boiler pipes [tubes] for heating installations; toilets [water-closets]; toilets, portable; humidifiers for central heating radiators; wash-hand basins [parts of sanitary installations]; toilet bowls; water conduits installations; bath installations; air-conditioning installations; desalination plants; installations for processing nuclear fuel and nuclear moderating material; watering installations, automatic; cooling installations for water; cooling installations for liquids; milk cooling installations; cooling installations for tobacco; water purification installations; purification installations for sewage; steam generating installations; water distribution installations; air filtering installations; swimming pool chlorinating apparatus; ventilation [air-conditioning] installations and apparatus; ventilation [air-conditioning] installations for vehicles; water softening apparatus and installations; cooling installations and machines; heating installations; heaters for vehicles; hot water heating installations; polymerization installations; water supply installations; flare stacks for use in the oil industry; ash conveyor installations, automatic; whirlpool-jet apparatus; air cooling

apparatus; aquarium filtration apparatus; cooking utensils, electric; flaming torches; headlights for automobiles; vehicle headlights; filters for air conditioning; filters for drinking water; lights for automobiles; bicycle lights; motorcycle lights; lights for vehicles; electric torches; lanterns for lighting; Chinese lanterns; fountains; ornamental fountains; deep fryers, electric; fittings, shaped, for ovens; oven fittings made of fireclay; bread-making machines; refrigerators; chromatography apparatus for industrial purposes; kettles, electric; dampers [heating]; book sterilization apparatus; refrigerating cabinets; ice boxes; carbon for arc lamps; heating elements.

Limited Liability Company "AKUSTICHESKAYA ZAMOROZKA", Skolkovo Innovation center, Bol'shoy bul'var, St. 42, bld. 1, fl. 4, office 1594, work place 9, RU-121205 Moscow, Russian Federation

Representative: Pushkov Anton, patent attorney, IP Center "Skolkovo" LLC, Nobelya St., 5, office 125, Skolkovo Innovation center, RU-121205 Moscow, Russian Federation

HAOFENG

1503751 05/08/2019

Class 20. Wind chimes [decoration]; mobiles [decoration]; statues

of wood, wax, plaster or plastic; figurines [statuettes] of wood, wax, plaster or plastic; ambroid plates; statuettes of resin; works of art made of lacquered wood; works of art made of resin; works of art made of glass fibre-reinforced plastic; works of art made of plaster.

Fengze Haomei Craft Co.,Ltd .Quanzhou, 12 Fengying Road, Beifeng Industrial Estate, Quanzhou, 362000 Fujian, China

Notings: Transliteration of the mark: HAO FENG. Translation of the mark or of words contained in the mark: "HAO" means heroic, "FENG" means harvest; "HAO FENG" has no special meaning.

MEXICAN

1503831 05/08/2019

Class 18. Bags; pocket wallets; handbags; briefcases; travelling bags; shoulder belts [straps] of leather; animal skins; umbrellas; walking sticks; furniture coverings of leather.

Guangzhou Scarecrow Industrial Co., Ltd., No.136, Floor 1 and 2, No.42 Gongyuanqian Road, Huadu District, Guangzhou City, Guangdong Province, China

Representative: Guangdong Zezheng Intellectual Property Service Co., Ltd., 7th Floor, Yangcheng Xiwan Building, No. 80-86, Xiwan Road, Liwan District, Guangzhou City, 510160 Guangdong Province, China

冬虫夏草
Dong Chong Xia Cao

1503873 16/10/2019

Class 34. Tobacco; chewing tobacco; cigarettes containing tobacco substitutes, not for medical purposes; cigarettes; electronic cigarettes; pipe tobacco; tobacco powder; snuff; cigars; cigarillos.

INNER MONGOLIA KUNMING CIGARETTE LIMITED LIABILITY COMPANY, NO.19 Daerdeng North Road, Saihan District, Huhhot City, 010020 Inner Mongolia Autonomous Region, China

Notings: Transliteration of the mark: DONG CHONG XIA CAO. Translation of the mark or of words contained in the mark: "DONG" MEANS "WINTER"; "CHONG" MEANS "INSECT"; "XIA" MEANS "SUMMER"; "CAO" MEANS "GRASS".

Representative: QIANHUI IP ATTORNEYS, 20F, Building 1, Zhongrun Century Center, NO. 12111, Jingshi Rd, Lixia District, Jinan, 250014 Shandong, China



1504043 29/05/2019

Class 1. Fire extinguishing compositions; fireproofing

preparations; spirits of salt; phenol for industrial purposes; surface-active chemical agents; water-purifying chemicals; anti-incrustants; chemicals for the manufacture of paints; solvents for varnishes; vulcanization accelerators; plasticizers; fire retarder; foaming agents in liquid form for fire-fighting; fire extinguishing and fire prevention compositions in powder form; ethyleneamine; chemical agents for manufacturing dyestuffs; abstergent; chemical preparations for firming; dispersions of plastics.

ZHEJIANG WANSHENG CO., LTD., Liangshui Development Zone, Linhai, 317000 Zhejiang, China

Representative: Beijing Gaowo International Intellectual Property Agency, Room 603, Floor 6, Huayi Holdings Tower, No. 11 Caihefang Road, Haidian District, Beijing, China



1505209 05/11/2019

Class 18. Leather and imitations of leather; trunks and suitcases; traveling bags, sports bags;

handbags, backpacks; beach bags, school bags, satchels, shopping bags; traveling trunks; travel bags for clothing and shoes; attaché cases and document cases, attaché cases for documents, briefcases (leather goods); purses, wallets, card holders (wallets), coin purses not of precious metal, key cases (leather goods); boxes of leather or imitation leather; traveling sets (leatherware); vanity cases, not fitted; pouches of leather, clutch bags (evening handbags); parasols; umbrellas; clothing for animals, bags for carrying animals.

Class 26. Belt buckles.

Priority Date Claimed: 07 May 2019 France

LOUIS VUITTON MALLETIER, 2 rue du Pont-Neuf, F-75001 Paris, France

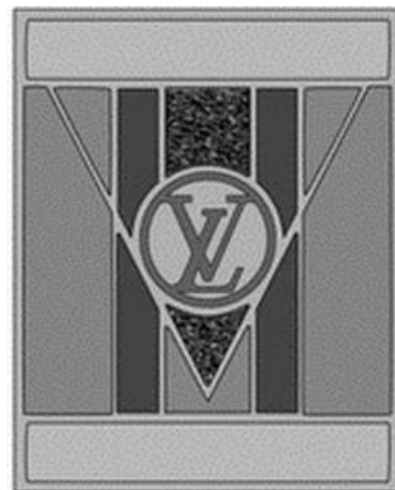

1505228 05/11/2019

Class 18. Leather and imitations of leather; trunks and suitcases; traveling bags, sports bags; handbags, backpacks; beach bags, school bags, satchels, shopping bags; traveling

trunks; travel bags for clothing and shoes; attaché cases and document cases, attaché cases for documents, briefcases (leather goods); purses, wallets, card holders (wallets), coin purses not of precious metal, key cases (leather goods); boxes of leather or imitation leather; traveling sets (leatherware); vanity cases, not fitted; pouches of leather, clutch bags (evening handbags); parasols; umbrellas; clothing for animals, bags for carrying animals.

Class 26. Belt buckles.

Priority Date Claimed: 07 May 2019 France

LOUIS VUITTON MALLETIER, 2 rue du Pont-Neuf, F-75001 Paris, France



1505237 05/11/2019

Class 18. Leather and imitations of leather; trunks and suitcases; traveling bags, sports bags; handbags, backpacks; beach bags, school bags, satchels, shopping bags; traveling trunks; travel bags for clothing and shoes; attaché cases and document cases, attaché cases for documents, briefcases (leather goods);

purses, wallets, card holders (wallets), coin purses not of precious metal, key cases (leather goods); boxes of leather or imitation leather; traveling sets (leatherware); vanity cases, not fitted; pouches of leather, clutch bags (evening handbags); parasols; umbrellas; clothing for animals, bags for carrying animals.

Class 25. Clothing, pullovers, vests, shirts, tee-shirts, trousers, jackets, suits, coats, raincoats, overcoats, parkas, skirts, dresses, shorts; pajamas, house coats, nightgowns and nightshirts, dressing gowns; hats, caps of all kinds, gloves (clothing), neckties, belts (clothing), leather belts, scarves, pocket squares (clothing), sashes for wear, shawls, stockings, socks, tights, suspenders, stoles; underwear, lingerie; bathing suits; footwear, slippers, boots and half-boots.

Priority Date Claimed: 07 May 2019 France

LOUIS VUITTON MALLETIER, 2 rue du Pont-Neuf, F-75001 Paris, France

Representative: SOCIETE LOUIS VUITTON SERVICES, Direction Propriété Intellectuelle, Mme. Sophie Regisser, 2 rue du Pont-Neuf, F-75001 Paris, France

International Trade Marks protected in the State

0702012 (2397) Cl. 9, 10
Anton Paar GmbH of Austria

1052659 (2397) Cl. 5
S.C. BIOFARM S.A. of Romania

1271984 (2397) Cl. 7 Lamello AG of Switzerland	1463217 (2397) Cl. 5 INVENTIVA of France
1342131 (2397) Cl. 7, 9 Shanghai Balance Automotive Equipment Co., Ltd. of China	1472405 (2397) Cl. 37, 40, 42 CBA World (Société anonyme) of Luxembourg
1426107 (2397) Cl. 3 ISDIN, S.A. of Spain	1472537 (2397) Cl. 38 Katharina von Johnston of Austria
1428318 (2397) Cl. 29, 35, 43 LuanDeYang of China	1472962 (2397) Cl. 41 BEIJING FANYIN YOGA FITNESS CENTER of China
1442764 (2397) Cl. 10 Dalian Wanchun Bulin Pharmaceutical, Co., Ltd. of China	1473033 (2397) Cl. 9 ZHUHAI COSLIGHT BATTERY CO., LTD. of China
1444349 (2397) Cl. 7 Shantui Construction Machinery Co., Ltd. of China	1473188 (2397) Cl. 3, 35 Egorov Alexey Vladimirovich of Russian Federation
1444754 (2397) Cl. 35, 36 Sunrise Brokers LLP of United Kingdom	1473310 (2397) Cl. 3, 5, 10 Hangzhou Techderm Biological Products Co., Ltd. of China
1446231 (2397) Cl. 9, 12 ECA ROBOTICS of France	1473456 (2397) Cl. 5 MONTEI CONSULTING INC. of Virgin Islands (British)
1449960 (2397) Cl. 6, 16, 20, 39, 42 Gütegemeinschaft Paletten e.V. of Germany	1473458 (2397) Cl. 9, 16, 35, 38, 41, 42 IST GROUP AB of Sweden
1450542 (2397) Cl. 4, 7, 9, 42 SHAANXI HEAVY-DUTY AUTOMOBILE CO., LTD. of China	1473513 (2397) Cl. 35 Beijing Huijutianxia Investment Co., Ltd. of China
1453093 (2397) Cl. 6, 16, 20, 39, 42 Gütegemeinschaft Paletten e.V. of Germany	1474889 (2397) Cl. 32 Nasco Foods Ltd of United Kingdom
1453317 (2397) Cl. 35, 38, 42 Wer liefert was? GmbH of Germany	1475694 (2397) Cl. 5 Bio-Thera Solutions, Ltd. of China
1455987 (2397) Cl. 3 Dalian Wanchun Bulin Pharmaceutical Co., Ltd. of China	1475695 (2397) Cl. 5 Bio-Thera Solutions, Ltd. of China
1458259 (2397) Cl. 3 MGM Resorts International of United States of America	1475698 (2397) Cl. 5 Bio-Thera Solutions, Ltd. of China
1458379 (2397) Cl. 35 Dalian Wanchun Bulin Pharmaceutical, Co., Ltd. of China	1475715 (2397) Cl. 5 Bio-Thera Solutions, Ltd. of China
1462548 (2397) Cl. 9, 14, 18, 24, 25, 35 Zalando SE of Germany	1475752 (2397) Cl. 1 JSR CORPORATION of Japan

1475849 (2397) Cl. 5
Torunskie Zakłady Materiałów
Opatrunkowych, Spółka Akcyjna of Poland

1476085 (2397) Cl. 19
BREWSTER HOME FASHIONS LLC of
United States of America

Cancellations effected for the following goods/services under the Madrid protocol

1231886 Kardin
Cancellation in respect of all goods and services registered at WIPO on 20/01/2020.

1483947 888 RED COLLECTION
Cancellation in respect of all goods and services registered at WIPO on 16/01/2020.

0971251 Key road
Cancellation in respect of all goods and services registered at WIPO on 09/01/2020.

Errata

Trademarks Removed from the Register under Section 48 and Rule 39 (2) of the 1996 Act and Rules

208146 In Journal Number 2364 of 25th of July 2018, in the list of Trademarks Removed through Non-Payment of Renewal Fees, trademark number 208146 was listed in error. This Trademark is still in force.

Trademarks Removed from the Register under Section 48 and Rule 39 (2) of the 1996 Act and Rules

208147 In Journal Number 2364 of 25th of July 2018, in the list of Trademarks Removed through Non-Payment of Renewal Fees, trademark number 208147 was listed in error. This Trademark is still in force.
